

NETGEAR®

24 PORT

10/100/1000 Mbps

Copper Gigabit Switch

Installation Guide

MODEL

GS 524T

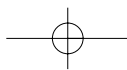
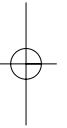
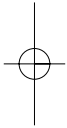

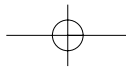

© 2002 by NETGEAR, Inc. All rights reserved.

Trademarks

NETGEAR® is a registered trademark of NETGEAR, Inc. in the United States and other Countries. All other trademarks and registered trademarks are the property of their perspective owners.

Statement of Conditions

In the interest of improving internal design, operational function, and/or reliability, NETGEAR reserves the right to make changes to the products described in this document without notice.

NETGEAR does not assume any liability that may occur due to the use or application of the product(s) or circuit layout(s) described herein.

Certificate of the Manufacturer/Importer

It is hereby certified that the NETGEAR Model GS524T Copper Gigabit Switch has been suppressed in accordance with the conditions set out in the BMPT-AmtsblVfg 243/1991 and Vfg 46/1992. The operation of some equipment (for example, test transmitters) in accordance with the regulations may, however, be subject to certain restrictions. Please refer to the notes in the operating instructions.

Federal Office for Telecommunications Approvals has been notified of the placing of this equipment on the market and has been granted the right to test the series for compliance with the regulations.

Voluntary Control Council for Interference (VCCI) Statement

This equipment is in the first category (information equipment to be used in commercial and/or industrial areas) and conforms to the standards set by the Voluntary Control Council for Interference by Data Processing Equipment and Electronic Office Machines that are aimed at preventing radio interference in commercial and/or industrial areas.

Consequently, when this equipment is used in a residential area or in an adjacent area thereto, radio interference may be caused to equipment such as radios and TV receivers.

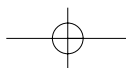

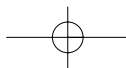

Federal Communications Commission (FCC) Compliance Notice: Radio Frequency Notice

This device complies with part 15 of the FCC Rules. Operation is subject to the following two conditions:

- This device may not cause harmful interference.
- This device must accept any interference received, including interference that may cause undesired operation.

Ⓢ **Note:** This equipment has been tested and found to comply with the limits for a Class A digital device, pursuant to part 15 of the FCC Rules. These limits are designed to provide reasonable protection against harmful interference in a residential installation. This equipment generates, uses, and can radiate radio frequency energy and, if not installed and used in accordance with the instructions, may cause harmful interference to radio communications. However, there is no guarantee that interference will not occur in a particular installation. If this equipment does cause harmful interference to radio or television reception, which can be determined by turning the equipment off and on, the user is encouraged to try to correct the interference by one or more of the following measures:

- Reorient or relocate the receiving antenna.
- Increase the separation between the equipment and receiver.
- Connect the equipment into an outlet on a circuit different from that which the receiver is connected.
- Consult the dealer or an experienced radio/TV technician for help.

EN 55 022 and EN 55 024 Statements

This is to certify that the Model GS524T Copper Gigabit Switch is shielded against the generation of radio interference in accordance with the application of Council Directive 89/336/EEC, Article 4a. Conformity is declared by the application of EN 55 022 Class A (CISPR 22) and EN 55 024.



Warning: This is a Class A product. In a domestic environment, this product may cause radio interference, in which case the user may be required to take appropriate measures.

Canadian Department of Communications Radio Interference Regulations

This digital apparatus (NETGEAR Model GS524T Copper Gigabit Switch) does not exceed the Class A limits for radio-noise emissions from digital apparatus as set out in the Radio Interference Regulations of the Canadian Department of Communications.

Règlement sur le brouillage radioélectrique du ministère des Communications

Cet appareil numérique (NETGEAR Model GS524T Copper Gigabit Switch) respecte les limites de bruits radioélectriques visant les appareils numériques de classe A prescrites dans le Règlement sur le brouillage radioélectrique du ministère des Communications du Canada.

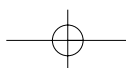

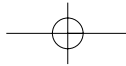

Customer Support

For assistance with installing and configuring your NETGEAR system or with questions or problems following installation:

- Check the NETGEAR Web page at <http://www.NETGEAR.com>.
- Call Technical Support at the phone number listed on the Support Information Card that shipped with your switch.
- Email Technical Support at support@NETGEAR.com.

Defective or damaged merchandise can be returned to your point-of-purchase representative.

Internet/World Wide Web

NETGEAR maintains a World Wide Web home page that you can access at the universal resource locator (URL) <http://www.NETGEAR.com>. A direct connection to the Internet and a Web browser such as Internet Explorer or Netscape are required.

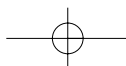

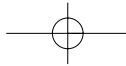

CONTENTS

CHAPTER 1

Introduction

Features	1-1
Package Contents	1-2

CHAPTER 2

Physical Description

Front Panel	2-1
RJ-45	2-2
Auto-uplink™	2-2
LEDs	2-4
Rear Panel	2-4

CHAPTER 3

Applications

Desktop Switching	3-1
Segment Switching and Bridging from 10 Mbps or 100 Mbps to 1000 Mbps	3-2

CHAPTER 4

Installation

Preparing the Site	4-1
Installing the Switch on a Flat Surface	4-2
Installing the Switch in a Rack	4-2
Connecting Devices to the Switch	4-2
Verifying Installation	4-3

CHAPTER 5

Troubleshooting

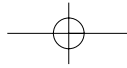
**APPENDIX A****Technical Specifications**

A-1

APPENDIX B**Connector Pin Assignments**

RJ-45 Plug and RJ-45 Connector

B-1

APPENDIX C**Cabling Guidelines**

Using 1000BASE-T Gigabit Ethernet over Category 5 Cable

C-1

Overview

C-1

Cabling

C-1

Length

C-1

Return Loss

C-2

Near End Cross Talk (NEXT)

C-2

Patch Cables

C-3

Conclusions

C-3

Fast Ethernet Cable guidelines

C-3

Category 5 Cable

C-4

Category 5 Cable Specifications

C-4

Twisted Pair Cables for 1000BASE-TX

C-5

Patch Panel and cables

C-6

FIGURES

Figure 1-1. Model GS524T Switch Package Contents	1-2
Figure 2-1. Front Panel of the Model GS524T Switch	2-1
Figure 2-2. Rear Panel of the Model GS524T Switch	2-2
Figure 2-3. Warning! Creating loops disables your network (Example 1)	2-3
Figure 2-4. Warning! Creating loops disables your network (Example 2)	2-3
Figure 2-5. Rear Panel of the Model GS524T Switch	2-4
Figure 3-1. Model GS524T Switch Used as a Desktop Switch	3-1
Figure 3-2. Model GS524T Switch Used as a Segment Switch	3-2
Figure 4-1. Attaching Mounting Brackets	4-2
Figure 4-2. Connecting to the Model GS524T Switch	4-3
Figure B-1. RJ-45 Plug and RJ-45 Connector with Built-in LEDs	B-1
Figure C-1. Straight-through Twisted Pair Cable	C-5
Figure C-2. Crossover Twisted Pair Cable	C-5
Figure C-3. Category 5e UTP Patch Cable with Male RJ-45 Plug at Each End	C-6

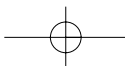

TABLES

Table 2-1. LED Descriptions	2-4
Table 4-1. Operating Environment Requirements	4-1
Table 5-1. Troubleshooting Information	5-1
Table B-1. 10/100/1000 Mbps RJ-45 Plug and RJ-45 Connector Pin Assignments	B-2
Table C-1. Electrical Requirements of Category 5 Cable	C-4

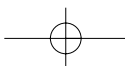

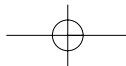

CHAPTER 1: INTRODUCTION

The NETGEAR® Model GS524T 24-Port Copper Gigabit Switch provides you with a low-cost, high-performance network solution and is designed to anchor and interconnect 10/100/1000 megabits per second (Mbps) workgroups using copper Gigabit links.

Features

The Model GS524T switch has the following key features:

- 24 full-duplex copper Gigabit ports with standard RJ-45 connectors
- Automatic address learning function to build the packet-forwarding information table. The table contains up to 32,000 media access control (MAC) addresses (that is, the switch can support networks with as many as 32,000 devices).
- Address aging function to automatically track changes in network configuration
- Protocol independence and compatibility with all common protocols, such as TCP/IP, Netware, DECNet, Microsoft Networks, and AppleTalk
- Full-duplex mode to double throughput of point-to-point connections by letting individual ports transmit and receive concurrently when the other end also supports full-duplex mode
- Wire-speed filtering and forwarding of the traffic
- Store-and-forward intelligent processing to minimize erroneous packets on the network
- Easy Plug and Play installation with no software to configure, which saves time and minimizes the potential for configuration errors
- Auto Uplink™ in all ports to make the right connection
- Auto-negotiation with link partners to speeds of 10, 100, or 1000Mbps on all ports
- Flow control traffic management to ensure no packets are dropped if there are back-ups or bottlenecks in the network

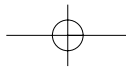

Package Contents

Figure 1-1 illustrates the Model GS524T switch package contents.

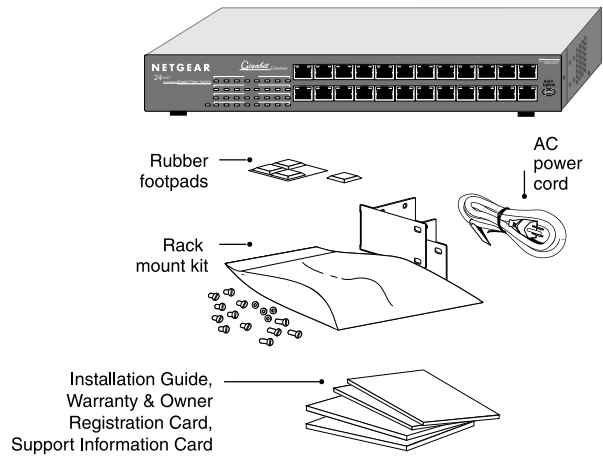
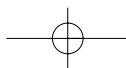
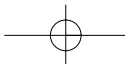

Figure 1-1. Model GS524T Switch Package Contents

Verify that your package contains the following:

- Model GS524T switch
- Rubber footpads for tabletop installation
- The Installation Guide
- Rack mount kit for 19-inch rack installation
- Warranty & Owner Registration Card
- Support Information Card
- Power cord





CHAPTER 2: PHYSICAL DESCRIPTION

This chapter describes the hardware features of the NETGEAR Model GS524T Copper Gigabit Switch.

Front Panel

The front panel of the Model GS524T switch contains the following LEDs that correspond to each network port: FDX/COL (full-duplex/collision), Activity(RX/TX)/10Mbps . Each network port has its own link and speed LEDs (located above each port).

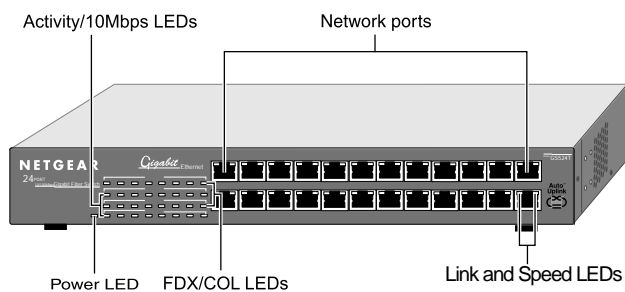
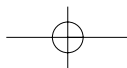
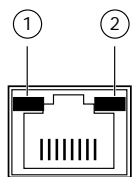

Figure 2-1. Front Panel of the Model GS524T Switch



RJ-45 Ports

The Model GS524T switch has 24 auto-sensing 10/100/1000 Mbps UTP ports. Each port can operate at 1000 Mbps full-duplex mode, 100 Mbps full/half duplex mode, or 10Mbps full/half duplex mode, and provide a standard UTP for Category 5 or Category 5e cable. Figure 2-2 shows a RJ-45 connector. For further information about Category 5 cables and connectors, refer to Appendix B, "Connector Pin Assignments," and Appendix C, "Cabling Guidelines." The 1000BASE-T requires very careful cable installation.



Key:
735EA
1 = 1000M Link LED
2 = 100M Link LED

Figure 2-2. RJ-45 Connector with Built-in LEDs

Auto Uplink

To simplify the procedure for attaching devices, all RJ-45 ports on the GS524T Switch support Auto Uplink. This technology allows you to attach devices to the RJ-45 ports using either straight-through or crossover cables. When you insert a cable into the switch's RJ-45 port, the switch automatically:

- Senses whether the cable is a straight-through or crossover cable, and
- Determines whether the link to the attached device requires a "normal" connection (such as when connecting the port to a PC) or an "uplink" connection (such as when connecting the port to a router, switch, or hub).

After detecting this information, the switch automatically configures the RJ-45 port to enable communications with the attached device, without requiring user intervention. In this way, the Auto Uplink technology compensates for setting uplink connections, while eliminating concern about whether to use crossover or straight-through-cables when attaching devices.

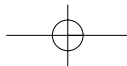

- ⇒ Note: Using Auto Uplink to create multiple active paths between any two network devices can cause undesirable loops in the network, resulting in an endless broadcast traffic that disables your network. Loops occur when there are alternate routes between two network devices. In Figure 2-3, for example, a loop is created by connecting two RJ-45 ports on a GS524T Switch to a router containing a 4-port switch. Figure 2-4 shows another scenario where a router with a 4-port switch connects to a hub and to a GS524T Switch; the hub and switch, in turn, connect back to the same router, creating multiple active paths between all three devices.

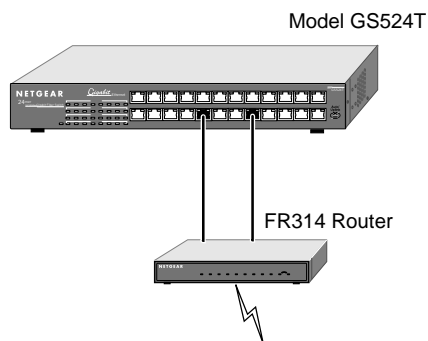

Figure 2-3. Warning! Creating loops disables your network(Example 1)

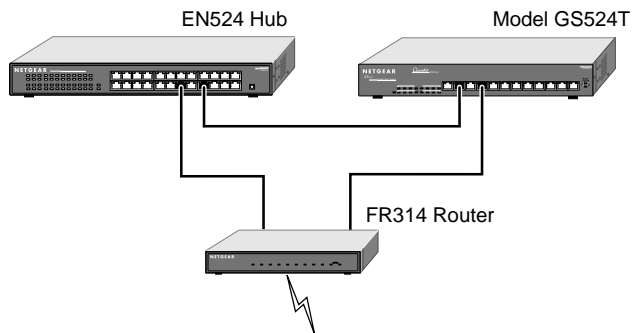
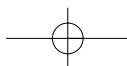
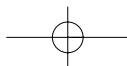

Figure 2-4. Warning! Creating loops disables your network(Example 2)





LEDs

Table 2-1 describes the activity of the LEDs.

Table 2-1. LED Descriptions

Label	Color	Activity	Description
Power	Green	On Off	Power is supplied to the switch. Power is disconnected.
FDX/COL	Green Yellow	On Off Blinking	The port is operating in full-duplex mode. The port is operating in half-duplex mode. Data collisions are occurring on the port. In a full-duplex environment, there is no collision. In a half-duplex environment, some collisions are normal.
Activity/ 10M	Green	Blinking On Off	Packet transmission or reception is occurring on the port. A valid 10 Mbps link is established on the port. No Activity on the port.
1000M	Green	On Off	A valid 1000 Mbps link is established on the port. A link is not established on the port.
100M	Green	On Off	A valid 100 Mbps link is established on the port. A link is not established on the port.

Rear Panel

As illustrated in Figure 2-5, the rear panel of the Model GS524T switch has fans for cooling and a standard AC Power Receptacle for the supplied power cord.

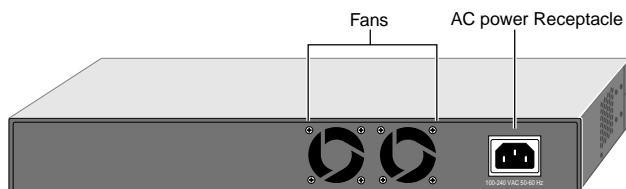
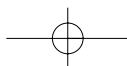

Figure 2-5. Rear Panel of the Model GS524T Switch



technology of the

CHAPTER 3: APPLICATIONS

This chapter presents an overview of the topologies possible by incorporating the NETGEAR Model GS524T Copper Gigabit Switch into your network.

Desktop Switching

Figure 3-1 illustrates the Model GS524T switch, used as a desktop switch to build a powerful network that enables users to have 1000 Mbps access to a file server. If a full-duplex adapter card is installed in the server or PC, a 2000 Mbps connection will be provided to each server and PC.

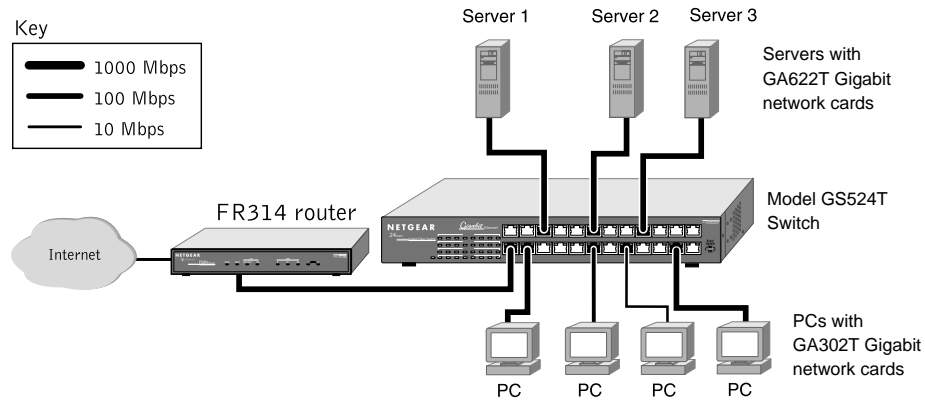
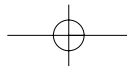

Figure 3-1. Model GS524T Switch Used as a Desktop Switch



Segment Switching and Bridging from 10 Mbps or 100 Mbps to 1000 Mbps

The Model GS524T switch, as illustrated in Figure 3-2, connects multiple power workgroups and servers using high-speed gigabit links. Each power workgroup is anchored by a NETGEAR Model FS518T switch. Other workgroups are connected by a NETGEAR FS524 switch. Because each copper link can be up to 100 m long, these workgroups can be located on separate floors.

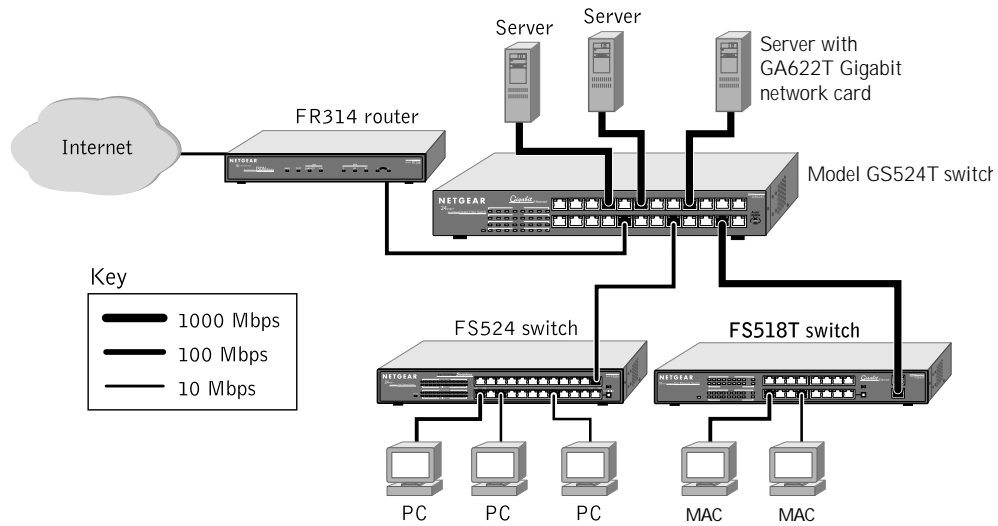
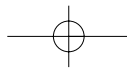
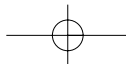

Figure 3-2. Model GS524T Switch Used as a Segment Switch





CHAPTER 4: INSTALLATION

This chapter describes the installation procedures for the NETGEAR Model GS524T Copper Gigabit Switch.

Preparing the Site

Before you begin installing your switch, prepare the installation site. Make sure your operating environment meets the operating environment requirements of the equipment listed in Table 4-1.

Table 4-1. Operating Environment Requirements

Characteristic	Requirements
Temperature	Ambient temperature between 0 and 40°C (32 and 104°F). No nearby heat sources such as direct sunlight, warm air exhausts, or heaters.
Operating humidity	Maximum relative humidity of 90%, noncondensing.
Ventilation	Minimum 2 inches (5.08 cm) on all sides for cooling. Adequate airflow in room or wiring closet.
Operating conditions	At least 6 ft (1.83 m) to nearest source of electromagnetic noise (such as photocopy machine or arc welder).
Power	Adequate power source within 6 ft (1.83 m).

Checking Package Contents

Unpack the contents of the package and verify them against the following list:

- NETGEAR Model GS524T Gigabit Ethernet Switch
- Self-adhesive rubber footpads for desktop installation
- Rack Mount Kit for rack installation
- AC power cord
- Warranty & Owner Registration Card

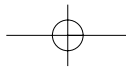

- The Installation Guide
- Support Information Card

Installing the Switch on a Flat Surface

To install the switch on a flat surface, be sure to attach the rubber footpads to the bottom of the switch.

Installing the Switch in a Rack

Refer to Figure 4-1 when installing the switch in a rack.

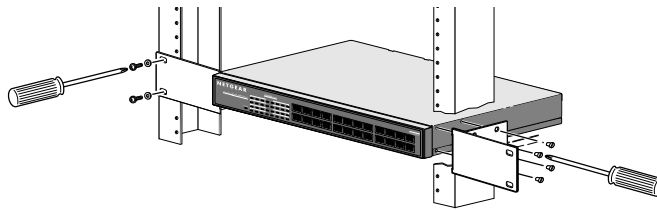

Figure 4-1. Attaching Mounting Brackets

Connecting Devices to the Switch

To connect the switch:

1. Connect the devices to the network ports on the switch, using Category 5 (Cat5) or Category 5e (Cat5e) UTP cable.

Note: Ethernet specifications limit the cable length between your PC or server and the switch to 100 m.

2. Connect one end of the AC power adapter cable to the power receptacle on the rear panel of the switch and the other end of the power adapter cable to the wall outlet.

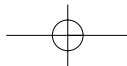

Refer to Figure 4-2 when connecting the switch.

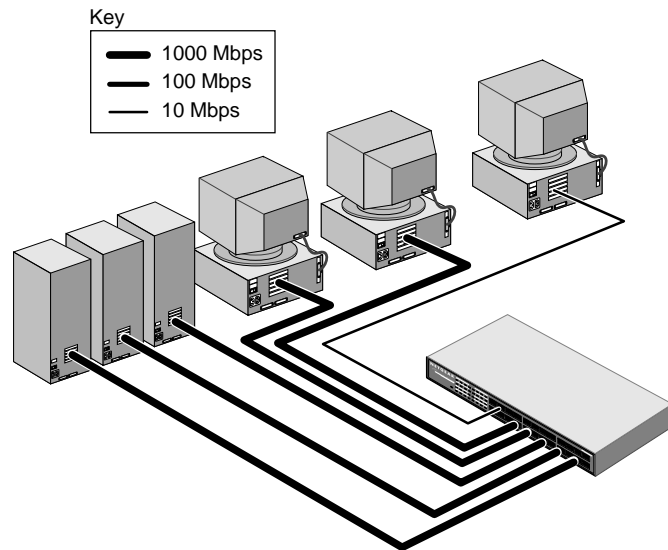

Figure 4-2. Connecting to the Model GS524T Switch

Verifying Installation

When power has been applied to the switch, verify that:

- The green power LED on the front panel is on.
- The green link LED on each connected port is on.

When the switch is connected and operating, refer to Table 2-1 "LED Descriptions" for information about the LEDs and their activity.

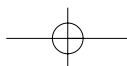

CHAPTER 5: TROUBLESHOOTING

This chapter provides information about troubleshooting the NETGEAR Model GS524T Copper Gigabit Switch. Table 5-1 lists symptoms, causes, and solutions of possible problems.

Table 5-1. Troubleshooting Information

Symptom	Cause	Solution
Power LED is off.	No power is received at the switch.	Check the power cord connections for the switch and the connected device. Make sure all cables used are correct and comply with Ethernet specifications.
1000M or 100M LED is off or intermittent.	Port connection is not functioning.	Check the crimp on the connectors and make sure that the plug is properly inserted and locked into the port at both the switch and the connecting device. Make sure all cables used are correct and comply with Ethernet specifications. See Appendix C. Check for a defective adapter card, cable, or port by testing them in an alternate environment where all products are functioning.
File transfer is slow or performance degradation is a problem.	Half- or full-duplex setting on the switch and the connected device are not the same.	Make sure the remote link partner is set to auto negotiate.
A segment or device is not recognized as part of the network.	One or more devices are not properly connected, or cabling does not meet Ethernet guidelines.	Verify that the cabling is correct. Be sure all cable connectors are securely positioned in the required ports. Equipment may have been accidentally disconnected.
COL LED is blinking yellow excessively.	Collisions are occurring on the connected segment. Duplex modes are mismatched.	Some collisions are normal when the connection is operating in half-duplex mode. Recheck the link partner settings.

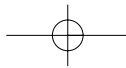

Network Adapter Cards

Make sure the network adapter cards installed in the PCs are in working condition and the software driver has been installed.

Configuration

If problems occur after altering the network configuration, restore the original connections and determine the problem by implementing the new changes, one procedure at a time. Make sure that cable distances, repeater limits, and other physical aspects of the installation do not exceed the Ethernet limitations.

Switch Integrity

If required, verify the integrity of the switch by resetting the switch. Turn power to the switch off and then back on. If the problem continues and you have completed all the preceding diagnoses, contact your NETGEAR point-of-sale representative.

Auto Negotiation

Each port will negotiate the correct duplex mode and speed, provided the link partner supports auto negotiation. If the link partner does not support auto negotiation, only the speed will be determined correctly and the duplex mode will default to half.

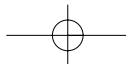

APPENDIX A: TECHNICAL SPECIFICATIONS

This appendix provides technical specifications for the NETGEAR Model GS524T Copper Gigabit Switch.

Network Protocol and Standards Compatibility

IEEE 802.3ab 1000BASE-T

IEEE 802.3u 100BASE-TX

IEEE 802.3i 10BASE-T

IEEE 802.3x flow control

Data Coding

1000 Mbps with PAM5 encoding

100 Mbps with MLT3 encoding

10 Mbps with Manchester encoding

Performance Specifications

Frame filter rate: (using 64-byte packets):	1,480,000 frames/second maximum(1000 Mbps)
	148,000 frames/second maximum(100 Mbps)
	14,800 frames/second maximum(10 Mbps)

Frame forward rate: (using 64-byte packets):	1,480,000 frames/second maximum(1000 Mbps)
	148,000 frames/second maximum(100 Mbps)
	14,800 frames/second maximum(10 Mbps)

Network latency (using 64-byte packets):	30 microseconds maximum
---	-------------------------

Address database size:	32,000 MAC addresses
------------------------	----------------------

Addressing:	48-bit MAC address
-------------	--------------------

Forwarding Mode:	Store & Forward
------------------	-----------------

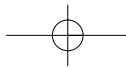

Interface

RJ-45 Connectors for 10BASE-T Ethernet, 100BASE-TX Fast Ethernet, and 1000BASE-T Gigabit Ethernet

Power Consumption

75 W

Heat Radiation:

34.9812 Btu/hr

Acoustic Noise:

50.2dB

Input Voltage (Power Adapter)

100–240 V AC

Physical Specifications

Dimensions: 13.0 x 1.7 x 8.0 in.; 33.0 x 4.3 x 20.7 cm

Weight: 5.3 lb; 2.3 kg

Environmental Specifications

Operating Temperature: 0 to 40° C (32 to 104° F)

Operating Humidity: 90% maximum relative humidity, noncondensing

Storage Temperature: -20° to 70° C (-4° to 150° F)

Storage Humidity: 95% maximum relative humidity, noncondensing

Electromagnetic Compliance

CE mark, commercial

FCC Part 15 Class A

VCCI Class A

EN 55022 (CISPR 22) Class A

EN 50082-1

EN 55024

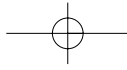

Safety Agency Approvals

UL Listed (UL 1950), cUL

TUV Licensed (EN 60 950)

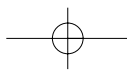
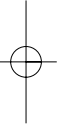
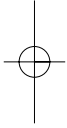

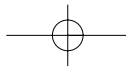

APPENDIX B: CONNECTOR PIN ASSIGNMENTS

This appendix provides information about the RJ-45 plug and the RJ-45 connector used for the NETGEAR Model GS524T Copper Gigabit Switch.

RJ-45 Plug and RJ-45 Connector

It is important that all 1000 BASE-T certified Category 5 or Category 5e cabling use RJ-45 plugs. The RJ-45 plug accepts 4-pair UTP or shielded twisted pair (STP) 100 ohm cable and connects into the RJ-45 connector.

The RJ-45 connector is used to connect stations, hubs, and switches through UTP cable; it supports 10 Mbps, 100 Mbps, or 1000 Mbps data transmission.

The RJ-45 plug and RJ-45 connector are both illustrated in Figure B-1.

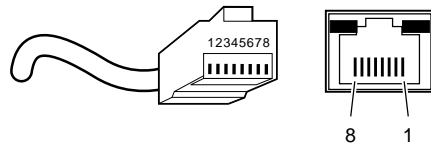

Key:
1 to 8 = pin numbers

Figure B-1. RJ-45 Plug and RJ-45 Connector with Built-in LEDs

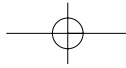
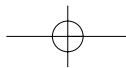
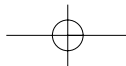

Table B-1 lists the pin assignments for the 10/100/1000Mbps RJ-45 plug and the RJ-45 connector.

Table B-1. 10/100/1000 Mbps RJ-45 Plug and RJ-45 Connector Pin Assignments

Pin	Channel	Description
1 2	A	Rx/Tx Data + Rx/Tx Data -
3 6	B	Rx/Tx Data + Rx/Tx Data -
4 5	C	Rx/Tx Data + Rx/Tx Data -
7 8	D	Rx/Tx Data + Rx/Tx Data -





APPENDIX C: CABLING GUIDELINES

This appendix provides specifications for cables used with the NETGEAR Model GS524T Copper Gigabit Switch.

Using 1000BASE-T Gigabit Ethernet over Category 5 Cable

Overview

When using the 1000BASE-T standard, the limitations of cable installations and the steps necessary to ensure optimum performance must be considered. The most important components in your cabling system are patch panel connections, twists of the pairs at connector transition points, the jacket around the twisted pair cable, bundling of multiple pairs on horizontal runs and punch down blocks. All of these will affect the performance of 1000BASE-T technology if not correctly implemented. The following sections are designed to act as a guide to correct cabling for 1000BASE-T.

Cabling

The 1000BASE-T product is designed to operate over Category 5 cabling, but to further enhance the operation, the cabling standards have been amended. The latest standard is Category 5e, which defines a higher level of link performance than is available with Category 5 cable.

If installing new cable, we recommend using Category 5e cable, since it costs about the same as Category 5 cable and will increase performance. If using the existing cable, be sure to have the cable plant tested by a professional who can verify that it meets or exceeds either ANSI/EIA/TIA-568-A:1995 or ISO/IEC 11801:1995 Category 5 specifications.

Length

The maximum distance limitation between two pieces of equipment is 100 m, as per the original Ethernet specification. The end to end link is called the "channel." TSB-67 defines the "Basic Link" which is the portion of the link that is part of the building infrastructure. This excludes patch and equipment cords. The maximum basic link length is 295 feet (90 m).

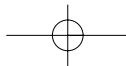

Return Loss

Return loss measures the amount of reflected signal energy resulting from impedance changes in the cabling link. The nature of 1000BASE-T renders this measurement very important; if too much energy is reflected back on to the receiver, the device will not perform optimally.

All four pairs of the twisted pair are used by 1000BASE-T, unlike 10BASE-T and 100BASE-TX, which use only two of the four pairs of wires within the Category 5. It is important to ensure that all wires are tested.

The factors that will affect the return loss are

- the number of transition points, as there is a connection via an RJ-45 to another connector, a patch panel, or a piece of equipment at each transition point.
- removal of the jacket that surrounds the four pairs of twisted cable. It is highly recommended that, where RJ-45 connections are made, this is minimized to 1-1/4 inch (32 mm).
- pair untwist of any of the twisted pairs. It is important that this be minimized to 3/8 inch (10 mm) where RJ-45 connections are made.
- cabling or bundling of multiple Category 5 cable. This is regulated by ANSI/EIA/TIA-568A-3, and can adversely affect all parameters of the cabling if not correctly implemented.

Near End Cross Talk (NEXT)

This is a measure of the signal coupling from one wire to another, within a cable assembly, or among cables within a bundle. NEXT measures the amount of cross-talk disturbance energy that is detected at the near end of the link—the end at which the transmitter is located. NEXT measures the amount of energy that is “returned” to the sender end. The factors that affect NEXT and cross talk are exactly the same as outlined in the Return Loss section. The cross-talk performance is directly related to the quality of the cable installation.

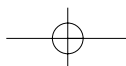

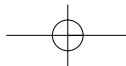

Patch Cables

When installing your equipment, replace old patch panel cables that do not meet Category 5e specifications. As pointed out in the NEXT section, this near end piece of cable is critical for successful operation.

Conclusions

For optimum performance of your 1000BASE-T product, it is important to fully qualify your cable installation and ensure it meets or exceeds ANSI/EIA/TIA-568-A:1995 or ISO/IEC 11801:1995 Category 5 specifications. Install Category 5e cable where possible, including patch panel cables. Minimize transition points, jacket removal, and untwist lengths. Bundling of cables must be properly installed in order to meet the requirements in ANSI/EIA/TIA-568A-3.

Fast Ethernet Cable Guidelines

Fast Ethernet uses UTP cable, as specified in the IEEE 802.3u standard for 100BASE-TX. The specification requires Category 5 UTP cable consisting of either two-pair or four-pair twisted insulated copper conductors bound in a single plastic sheath. Category 5 cable is certified up to 100 MHz bandwidth. 100BASE-TX operation uses one pair of wires for transmission and the other pair for receiving and for collision detection.

When installing Category 5 UTP cabling, use the following guidelines to ensure that your cables perform to the following specifications:

- Certification

Make sure that your Category 5 UTP cable has completed the Underwriters Laboratories (UL) or Electronic Testing Laboratories (ETL) certification process.

- Termination method

To minimize cross-talk noise, maintain the twist ratio of the cable up to the point of termination; untwist at any RJ-45 plug or patch panel should not exceed 0.5 inch (1.5 cm).

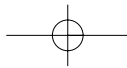

Category 5 Cable

Category 5 distributed cable that meets ANSI/EIA/TIA-568-A building wiring standards can be a maximum of 328 feet (ft) or 100 meters (m) in length, divided as follows:

- 20 ft (6 m) between the hub or switch and the patch panel (if used)
- 295 ft (90 m) from the wiring closet to the wall outlet
- 10 ft (3 m) from the wall outlet to the desktop device

The patch panel and other connecting hardware must meet the requirements for 100 Mbps operation (Category 5). Only 0.5 inch (1.5 cm) of untwist in the wire pair is allowed at any termination point.

Category 5 Cable Specifications

Table C-1 lists the electrical requirements of Category 5 UTP cable.

Table C-1. Electrical Requirements of Category 5 Cable

Specification	Category 5 Cable Requirements
Number of pairs	Four
Impedance	100 Ω \pm 15%
Mutual capacitance at 1 KHz	\leq 5.6 nF per 100 m
Maximum attenuation (dB per 100 m, at 20° C)	at 4 MHz: 8.2 at 31 MHz: 11.7 at 100 MHz: 22.0
NEXT loss (dB minimum)	at 16 MHz: 44 at 31 MHz: 39 at 100 MHz: 32

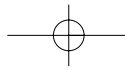

Twisted Pair Cables for 100 BASE-TX

For two devices to communicate, the transmitter of each device must be connected to the receiver of the other device. The crossover function is usually implemented internally as part of the circuitry in the device. Computers and workstation adapter cards are usually media-dependent interface ports, called MDI or uplink ports. Most repeaters and switch ports are configured as media-dependent interfaces with built-in crossover ports, called MDI-X or normal ports.

Auto Uplink™ automatically senses which connection, MDI or MDI-X, is needed and makes the right connection.

Figure C-1 illustrates straight-through twisted pair cable.

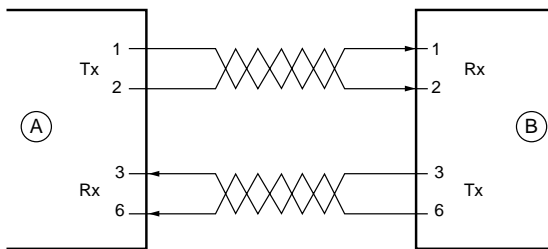

Key:

A = Uplink or MDI port (as on a PC)

B = Normal or MDI-X port (as on a hub or switch)

1, 2, 3, 6 = Pin numbers

Figure C-1. Straight-Through Twisted Pair Cable

Figure C-2 illustrates crossover twisted pair cable.

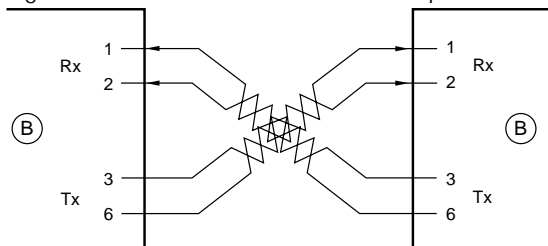

Key:

B = Normal or MDI-X port (as on a hub or switch)

1, 2, 3, 6 = Pin numbers

Figure C-2. Crossover Twisted Pair Cable

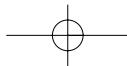

Patch Panels and Cables

If you are using patch panels, make sure that they meet the 100BASE-TX requirements. NETGEAR recommends Category 5e UTP cable for all patch cables and work area cables to ensure that your UTP patch cable rating meets or exceeds the distribution cable rating.

To wire patch panels, you need two Category 5e UTP cables with an RJ-45 plug at each end, as shown in Figure C-3.

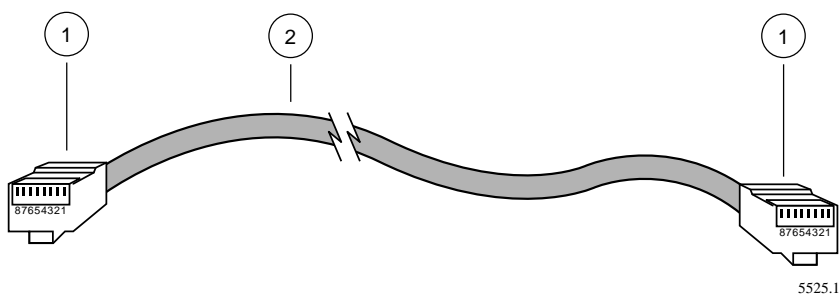

Key:

1 = RJ-45 plug

2 = Category 5e UTP patch cable

Figure C-3. Category 5e UTP Patch Cable with Male RJ-45 Plug at Each End

- ⓘ **Note:** Flat “silver satin” telephone cable may have the same RJ-45 plug. However, using telephone cable will result in excessive collisions and cause the attached port to be partitioned or disconnected from the network.

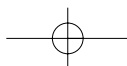

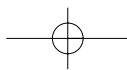
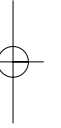
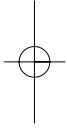
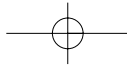

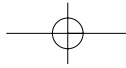

NETGEAR®

NETGEAR, Inc.
4500 Great America Parkway
Santa Clara, CA 95054 USA
Phone: 1-888-NETGEAR
www.NETGEAR.com

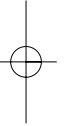
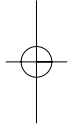

M - G S 5 2 4 T N A - 0

