



Installation Guide

BE5000 Dual-Band PoE 2.5G
Insight Managed WiFi 7 Access Point
Model WBE708



Package contents



Access Point Model WBE708

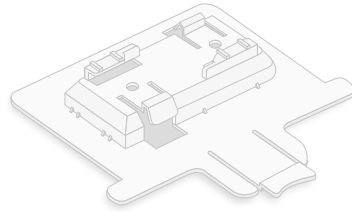

Mounting bracket for a solid wall or ceiling, or 15/16 in. (23.8 mm) T-bar.



Two screws and anchors for ceiling or wall mounting.

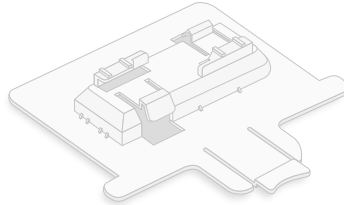

Mounting bracket for a 9/16 in. (14.3 mm) T-bar.

NOTE: You can power up the WBE708 access point by connecting it to a PoE switch or a power adapter. The package does not include a power adapter. You can purchase one separately from NETGEAR.

Overview



1 Single LED

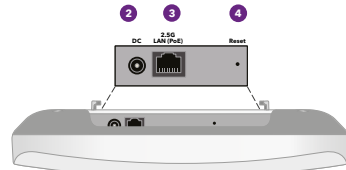

2 DC power connector

3 LAN PoE port

4 Reset button



CAUTION: Terms of Use

This device must be professionally installed. It is the installer's responsibility to follow local country regulations including operations within legal frequency channels, output power and DFS requirements. Vendor or Reseller or Distributor is not responsible for illegal wireless operations. Please see Device's Terms and Conditions for more details.

1. Connect the WBE708 to your network

Before you install the WBE708 access point (AP) at its permanent location, first test the AP by connecting it to your network and powering it up

NOTE: The multiple mounting options for the AP are described in the NETGEAR Pro WiFi Mount Installation Guide, which you can download from the NETGEAR Download Center at netgear.com/support/download. The QR code for the NETGEAR Download Center is shown at the right.



⚠ CAUTION: After you are done testing the AP, power off the AP and let it cool down for 10 minutes before you mount it at its permanent location.

The AP is designed to use a PoE cable for power and Internet, but you can use a separately purchased 12V (1.5A) power adapter and Ethernet cable:

- Use a PoE cable: Connect one end of an Ethernet cable to the LAN/PoE port of the AP and connect the other end to a PoE+ switch port that supplies 802.3at PoE+ power. Make sure that the switch has Internet connectivity.
- Use a 12V (1.5A) power adapter: Connect the power adapter's DC plug to the AP, and insert the power adapter in a power outlet. Next, connect one end of an Ethernet cable to the LAN/PoE port of the AP, and connect the other end to a port on a switch or router with an Internet connection.

The power LED on the AP lights. For more information, see the table with LED information.







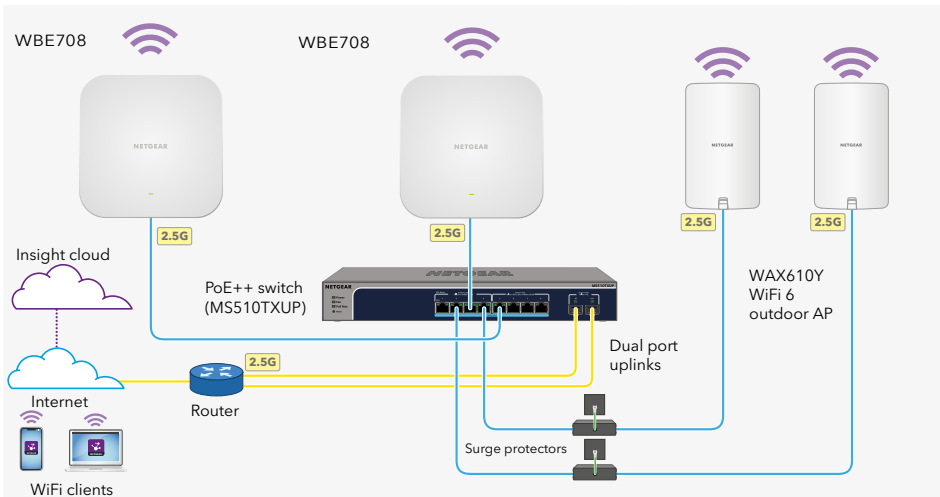





The AP receives an IP address from a DHCP server (usually a router in your network). If your network does not include a DHCP server, the AP uses its default IP address: 192.168.0.100.

NOTE: The AP receives an IP address from a DHCP server or router in your network. If the AP does not receive an IP address, it uses its default IP address: 192.168.0.100.

Sample connections



After starting up and during setup, the LED can light in these colors:

Normal behavior	
	Off: No power is supplied to the AP.
	Solid amber, temporarily: The AP is starting or the Reset button was pressed.
	Solid magenta: The AP is initializing.
	Blinking magenta, slowly: The AP continues to initialize.
	Blinking amber fast, temporarily: The AP is updating firmware or is being reset to factory default settings.
	Solid blue: The AP started up, functions in Insight mode, and is connected to the Insight cloud-based management platform.
	Solid green: The AP started up and functions as a standalone access point.
	Blinking blue: At least one WiFi client is connected to the AP. The speed of blinking depends on the transmit and receive data rate of connected clients.
	Blinking multicolor: The AP is functioning as a node in an Insight Instant Mesh WiFi Network and the mesh setup is in progress.
	Blinking green, continuously: At least one WiFi client is connected while the access point functions as a standalone access point. Blinking green might also occur in a wireless distribution system (WDS), when a connection is established between the WiFi base station and the WiFi repeater.
Problem indication	
	Blinking amber slowly, continuously: The AP did not receive an IP address from a DHCP server
	Solid amber, continuously: A boot error occurred or the AP is malfunctioning.

NOTE: Other LED behavior exists. For more information about the LED behavior, see the user manual, which you can download by visiting netgear.com/support/download.

2. Discover and manage the AP

Your new AP supports the NETGEAR Insight cloud-based management platform for remote management. Insight offers automated monitoring and notifications, plus add-on services like Insight Instant Mesh that are not available in standalone mode. Alternatively, you can manage the AP locally in standalone mode through the device UI.

For information about creating an Insight Premium account or Insight Pro account, visit kb.netgear.com/000044343. Your my.NETGEAR.com account is also your Insight account, so your credentials let you log into the Insight Cloud Portal or the Insight app. For more information, visit the following pages:

- netgear.com/business/services/insight
- kb.netgear.com/000061848

To manage the AP, use one of the methods in this table:

A.	NETGEAR Engage Controller: See A. Use the NETGEAR Engage Controller to discover and manage the AP
B.	Web browser: See B. Configure the AP as standalone in a web browser
C.	NETGEAR Insight Cloud Portal or NETGEAR Insight app remote management See C. Use the NETGEAR Insight to discover and manage the AP

NOTE: NETGEAR Insight, the NETGEAR Engage Controller, and the device UI are mutually exclusive management methods.

A. Use the NETGEAR Engage Controller to discover and manage the AP

You can use the NETGEAR Engage Controller to discover and manage the AP. The Engage Controller provides central management and configuration of APs and other supported devices through an audio-video (AV)-friendly, portable app for Windows and MacOS.

This section refers to a setup where the Engage Controller is already installed. To download and install the Engage Controller, see the instructions in the user manual. You can download the manual from the NETGEAR Download Center at netgear.com/support/download. The QR code for the NETGEAR Download Center is shown at the right.



1. On your computer, in the folder in which you installed the controller application, double-click the **Engage** application icon, or double-click the **Engage** shortcut.
2. In the **Login Name** field, enter **admin** as the user name, in the **Password** field, enter the controller password you set up the first time you logged in, and click the **Login** button.
3. If you set up more than one site, from the Site menu, select the site.
In the Edit Network Setup pop-up window, do one of the following:
 - **Make no changes to the network setup for the site:** Click the Apply button.
 - **Change the network setup for the site:** Change the network setup and click the **Apply** button. For more information, see the Engage Controller user manual.

4. Click the **Onboard** button for the device.
A warning pop-up window displays.
5. Click the **Continue** button.
The Wireless Setup pop-up window displays.
6. As an option, if you did not yet set up the global site SSID and the region and county for WiFi operation, configure the following setting:
 - a. In the **SSID** field, enter the name for the WiFi network (SSID).
 - b. In the **Password** field, enter the password for access to the WiFi network, which uses WPA-MPSK security. For more information about the WiFi security, see the Engage Controller user manual, which you can download by visiting netgear.com/support/download.
 - c. From the **Region** menu, select the region for the country in which the default site is located. After setup, you cannot change the region.
 - d. From the **Country** menu, select the country in which the default site is located. After setup, you cannot change the country.

7. Click the **Apply** button.

Your settings are saved. The Add Device pop-up window displays.

Because the AP must be in the factory default state, the **Use device default password** toggle is automatically enabled so that it displays blue or green and is positioned to the right.

8. Click the **Single** button.

Your settings are saved.

The AP is moved to the Managed Devices table, and the onboarding process is now in progress.

NOTE: For instructions to add multiple APs simultaneously, see the Engage Controller user manual.

NOTE: At the end of this procedure, the controller pushes the site password to the AP (which replaces the local device password or default password). If the firmware version on the AP does not support the controller, the controller automatically updates the firmware, after which the device restarts. When these processes are complete, the AP becomes a managed device and moves out of the Pending state to the Online state. This process might take up to 10 minutes.

9. To save the settings to the running configuration, at the top right of the page, click the **Save** button.

For information about managing the AP with the Engage Controller, see the Engage Controller user manual. You can download the manual from the NETGEAR Download Center at netgear.com/support/download/.

B. Configure the AP as standalone in a web browser

Use this method if you want to operate the AP in standalone mode.

1. Connect your computer or mobile device to the AP's setup SSID (WiFi network name) using one of the following methods:
 - **Scan the QR code:** Scan the QR code on the AP label to connect to the setup SSID.
 - **Connect manually:** The setup SSID is on the AP label and is shown in the format NETGEARxxxxxx-SETUP, where xxxxxx are the last six digits of the AP's MAC address. The default WiFi passphrase is **sharedsecret**.
2. On your computer, launch a web browser and, in the address bar, enter **aplogin.net**.

Your browser might display a security warning because of the self-signed certificate on the AP, which is expected behavior. You can proceed, or add an exception for the security warning. For more information, see kb.netgear.com/000062980.
3. Enter the AP user name and default password. The user name is **admin**. The default password is **password**. The user name and password are case-sensitive.
4. Select the **Web-browser (Local)** radio button.

The Day Zero Easy Setup page displays.
5. Follow the instructions on the Day Zero Easy Setup page, and then click the **Apply** button.

We recommend that you make a note of the new admin password, SSID (WiFi network name), WiFi passphrase, and IP address to keep in a safe place.

A message displays to indicate that your settings are being applied.
6. If the WiFi connection of your computer or mobile device is terminated, reconnect to the AP using the new SSID and WiFi passphrase that you set on the Day Zero Easy Setup page.
7. When the login page displays, you can log in to the AP using your new admin password to configure the AP.

For information about configuring the AP, see the user manual, which you can download by visiting netgear.com/support/download.

We recommend that you register your AP with NETGEAR.
8. To register your AP with NETGEAR, from a computer or mobile device that is connected to the Internet, visit my.NETGEAR.com to log in or create a new account, then click the **Register New Product** button to register your AP.

A confirmation email is sent to your NETGEAR account email address.

C. Use the NETGEAR Insight to discover and manage the AP

For NETGEAR Insight Premium and Insight Pro subscribers, the access point supports the NETGEAR Insight Cloud Portal and NETGEAR Insight app. You can use either of these options to discover and manage the AP.

CAUTION: If you add the AP to Insight before connecting it to power for the first time, wait 10 minutes to allow the default login credentials to be replaced by the Insight network location credentials. However, if you want to manage the AP as a standalone device, do not add the AP to Insight before connecting it to power for the first time. You can always add the AP to Insight after initial configuration.

Use the NETGEAR Insight Cloud Portal to discover and manage the AP

You can discover and manage the AP through the portal of the Insight cloud-based management platform.

1. On a computer or tablet, visit insight.netgear.com.
2. Enter the email address and password for your NETGEAR account and click the **NETGEAR Sign In** button.
3. If you are an Insight Pro user, select the organization to which you want to add the AP.
4. Add a new network location where you want to add the AP, or select an existing network location. The device admin password that you set for the network location replaces the existing admin password on all devices that you add to the network location.
5. Click the **+ (Add Device)** button.
NOTE: If you are an Insight Pro user, you can either add a single device or you can add multiple Insight-managed devices by uploading a device list in a CSV file.
6. On the Add New Device pop-up page, enter the AP's serial number and MAC address, then click **Go**.
7. Optionally change the device name of the AP, then click **Next**.

A page displays a confirmation that setup is in progress.

If the AP is online but Insight does not detect the AP, the firewall at the physical location where the AP is located might prevent communication with the Insight cloud. In that situation, add port and DNS entries for outbound access to the firewall. For more information, see kb.netgear.com/000062467.

The AP automatically updates to the latest Insight firmware and Insight location configuration. This might take up to 10 minutes, during which time the AP will restart.

The LED lights solid blue when the AP is connected to Insight. The AP is now an Insight managed device that is connected to the Insight cloud-based management platform.

Use the NETGEAR Insight app to discover and manage the AP

The Insight app provides a convenient way to add new devices, receive real-time notifications, and manage your network from anywhere.

1. Connect your mobile device to the AP's setup SSID (WiFi network name) using one of these methods:
 - **Scan the QR code:** Scan the QR code on the AP label to connect to the setup SSID.
 - **Connect manually:** The setup SSID is on the AP label and is shown in the format NETGEARxxxxxx-SETUP, where xxxxxx are the last six digits of the AP's MAC address. The default WiFi passphrase is **sharedsecret**.

2. Open the NETGEAR Insight app.
3. Enter the email address and password for your account and tap **LOG IN**.
4. Select a network location, or add a new network location where you want to add the AP by tapping the **Next button** and then tapping **OK**.

The device admin password that you set for the network location replaces the existing admin password on all devices that you add to the network location.

In most situations, Insight detects the AP automatically, which can take several minutes.

5. To add the AP to your network location, do one of the following:
 - If the AP is automatically detected and listed in the Insight Manageable Devices section, tap the icon for the AP, and then tap the **ADD DEVICE** button.
 - If the AP is not automatically detected, or you prefer to use another method to add the AP, tap the **+** icon in the top bar, and do one of the following:
 - Tap the **SCAN BARCODE OR QR CODE** button, and then scan the AP's code.
 - Tap the **Enter Serial Number and MAC Address** link, and then manually enter the AP's serial number and MAC address.

6. If prompted, name the AP and tap the **Next** button.

The AP automatically updates to the latest Insight firmware and Insight location configuration. This might take up to 10 minutes, during which time the AP will restart.

The LED lights solid blue when the AP is connected to Insight. The AP is now an Insight managed device that is connected to the Insight cloud-based management platform.

Installation options

You can mount the AP to a solid surface (a wall or a ceiling) or to a ceiling with a 9/16 in. (14.3 mm) or 15/16 in. (23.8 mm) T-bar, or you can install the AP freestanding on a flat surface.

We recommend that you use a flat Ethernet cable so that the cable fits in the narrow space between the AP and the surface on which it is mounted or placed.

Before you mount the AP, first set up and test the AP to verify WiFi network connectivity.

Mount to a solid wall

⚠ CAUTION: If you mount the AP to a solid wall, make sure that the wall is not damaged. For example, water damage can destroy a drywall. Similarly, if you mount the AP to a solid ceiling, make sure that the ceiling is not damaged. For example, water leaks can damage a ceiling.

1. Mark the wall where you want to insert the provided anchors and screws, which must be 3.875 in. (98.5 mm) apart, and insert the anchors and screws. Leave about 0.25 in. (6 mm) of each screw protruding from the wall so that you can insert the screws into the holes on the bottom of the AP.



2. Line up the holes on the bottom of the AP with the screws in the wall and mount the AP to the wall.

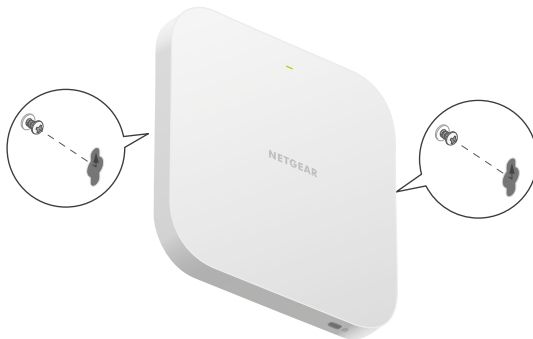

Mount to a solid wall

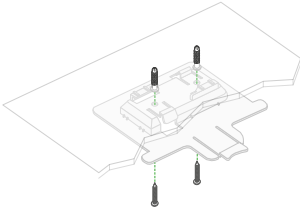

1. Using the anchors and screws provided, attach the 15/16 in. (23.8 mm) bracket with the screw holes to the ceiling. The rectangular protruding part of the bracket must be facing the ceiling.

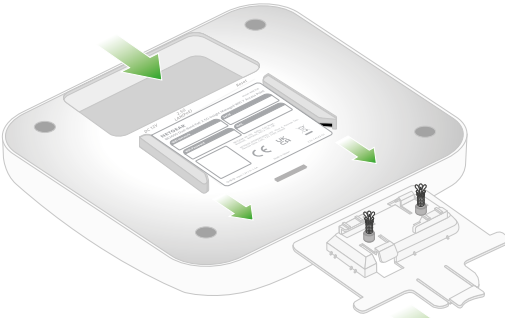

2. Hold the AP upside down with the front of the AP facing the bracket. Then, line up the guides on the bottom of the AP with the bracket.

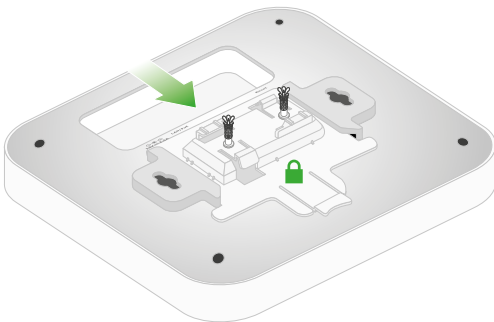
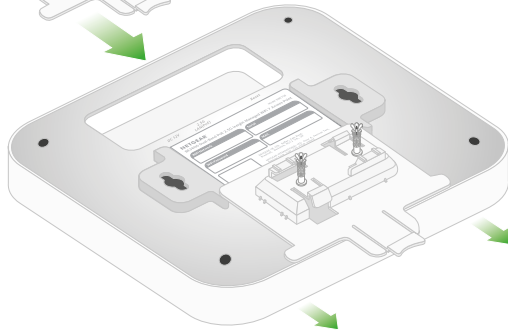

3. Slide the AP into the bracket until it locks in place. The locking tab must be at the front of the AP.

NOTE: To unlock the AP, push the locking tab toward the ceiling and slide the AP out of the bracket.

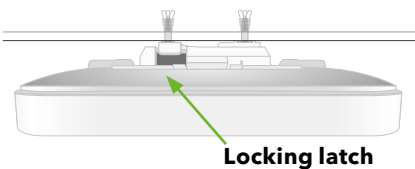

Side view

Locking latch

Mount to a T-bar

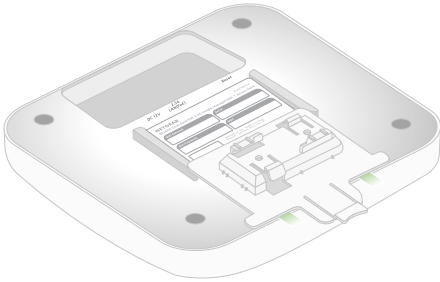

1. Depending on the size of the T-bar, slide the 9/16 in. (14.3 mm) or 15/16 in. (23.8 mm) bracket between the guides on the bottom the AP (left figure below) until it locks in place (right figure below). The locking tab must be at the back of the AP (the side with the LED).

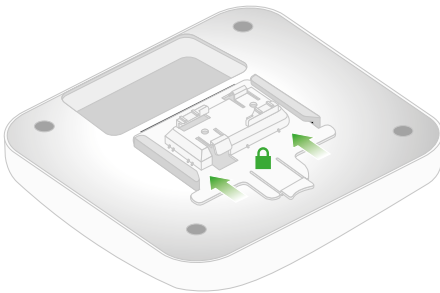

2. Hold the AP upside down.
NOTE: If you can reach behind the T-bar, hold the T-bar with one hand and the AP with your other hand.

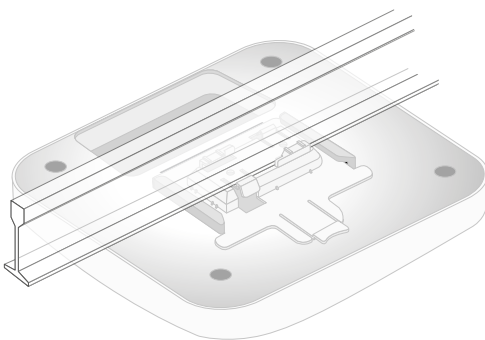

3. Align the rectangular protruding part of the bracket with the T-bar.
4. Hook the bracket onto one side of the T-bar.
5. Hook the bracket onto the other side of the T-bar until the bracket locks onto the T-bar.

Support and Community

Visit [netgear.com/support](https://www.netgear.com/support) to get your questions answered and access the latest downloads.

You can also check out our NETGEAR Community for helpful advice at community.netgear.com.

Regulatory and Legal

Si ce produit est vendu au Canada, vous pouvez accéder à ce document en français canadien à <https://www.netgear.com/support/download/>.

(If this product is sold in Canada, you can access this document in Canadian French at <https://www.netgear.com/support/download/>.)

For regulatory compliance information including the EU Declaration of Conformity, visit <https://www.netgear.com/about/regulatory/>.

See the regulatory compliance document before connecting the power supply.

For NETGEAR's Privacy Policy, visit <https://www.netgear.com/about/privacy-policy>.

By using this device, you are agreeing to NETGEAR's Terms and Conditions at <https://www.netgear.com/about/terms-and-conditions>. If you do not agree, return the device to your place of purchase within your return period.

Do not use this device outdoors. The PoE source is intended for intra building connection only.

March 2026

NETGEAR, Inc.

NETGEAR INTERNATIONAL LTD



201-33442-01

© NETGEAR, Inc., NETGEAR and the NETGEAR Logo are trademarks of NETGEAR, Inc. Any non-NETGEAR trademarks are used for reference purposes only.