

M4350 IT and AV Managed Switches

Designed for the most demanding campus IT deployments, supporting thousands of endpoints. The M4350 delivers the simplicity of the M4250 series, enhanced with enterprise-class hardware, including redundant power supplies and larger fabrics with 25G and 100G uplinks. The intuitive NETGEAR IT-GUI and Intelligent Insights Cloud management support enables seamless integration with enterprise network devices, ensuring robust and scalable campus connectivity.



IT Target Application

Core

At the core, two powerful M4350 models can be stacked. For maximum performance, and best reliability, two switches should be the limit

- Management unit hitless failover and nonstop forwarding ensure no single point of failure
- The interconnect should provide headroom: for instance, all the multicast in the present network will be replicated between the two core switches

Building 1

- For midsize server installations, two half-width M4350 10GbE models can be paired in a single rack space for redundant top-of-rack
- Management unit hitless failover and nonstop forwarding ensure no single point of failure for servers and storage

Building 2

- Common for intermediate distribution frames (IDF) in K-12 and other large campuses, stacking topologies greatly simplify deployments at the edge
- While reducing the number of logical units to manage, stacking also brings network resiliency with distributed uplinks in aggregation to the core

Building 3

- For typical collapsed core installations, with a variety of 1G, 2.5G, 10G, and 25G access ports in branch offices, server rooms or campus high performance labs
- Double star architectures deliver highest performance with every leaf switch connecting to every spine switch

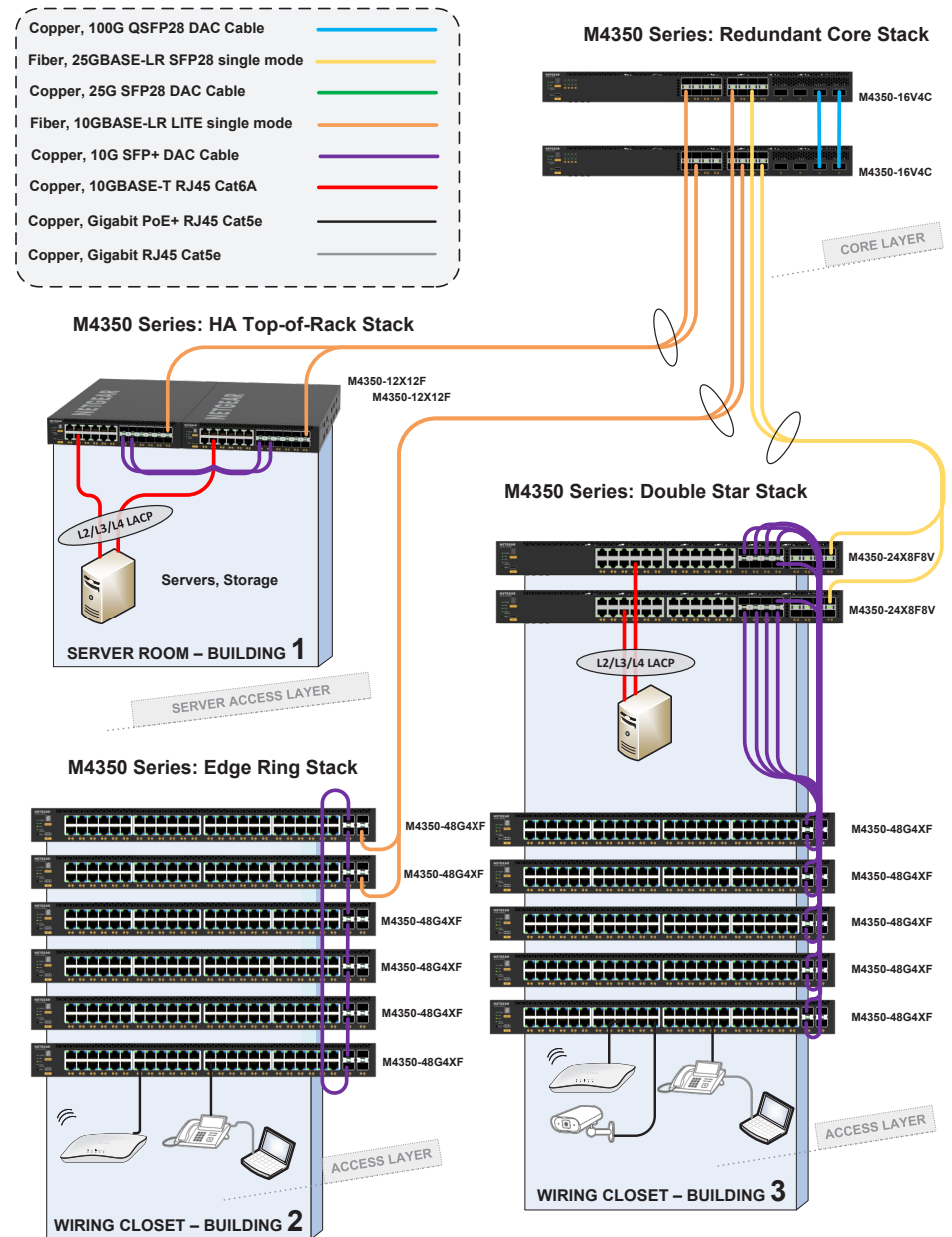

M4350 Series Features



The NETGEAR M4350 series is a versatile 1G, 2.5G, 10G, 25G, and 100G solution designed for the edge, the server room, and the core. M4350 delivers nonstop forwarding stacking, spine and leaf, edge to core connectivity for Campus IT networks.

NETGEAR M4350 series key features:

- Ranges from 1G to 100G with a variety of PoE+ and Ultra90 PoE++ options for 15.4W, 30W, 60W, 75W and 90W AVoIP endpoints
- Non-stop forwarding (NSF) provides advanced High Availability (HA) with hitless failover across the stack
- Entire feature set (L2 switching, L3 dynamic routing, time sensitive networking, AVB) available without license
- Low acoustics, half-width 16-port and 24-port 10G models can be paired in a single rack space for redundant Top of Rack
- For the IT team, only one platform from the edge to the core, one software to standardize on
- Redundant modular power supplies contribute to business continuity management
- Layer 3 feature set includes static and policy-based routing, RIP, VRRP, OSPF, and PIM dynamic routing

- No need for tradeoffs anymore between performance, reliability, HA, features, scale, futureproofing, complexity, or cost
- Front to back cooling, always within 40cm (15.7in) depth and controlled thermal and acoustics
- Intelligent fans configurable in Quiet Mode to minimize noise, or Cool Mode to minimize heat

NETGEAR M4350 series other software features:

- Static, RIP and PIM-SM, DM and SSM multicast routing, DHCP Server and PTPv2 Transparent Clock (1-step E2E)
- Advanced classifier-based, time-based hardware implementation for L2 (MAC), L3 (IP) and L4 (UDP/TCP transport ports) security and prioritization
- Selectable Port-Channel / LAG (802.3ad - 802.1AX) L2/L3/L4 hashing for fault tolerance and load sharing with any type of Ethernet channeling

M4350 Series Features

- Voice VLAN with SIP, H323 and SCCP protocols detection and LLDP-MED IP phones automatic QoS and VLAN configuration
- Efficient authentication tiering with successive DOT1X, MAB and Captive Portal methods for streamlined BYOD
- Advanced IPv4/IPv6 security implementation including malicious code detection, DHCP Snooping, IP Source Guard protection and DoS attacks mitigation

NETGEAR M4350 series management features:

- DHCP/BootP innovative auto-installation including firmware and configuration file upload automation
- Industry standard SNMP, RMON, MIB, LLDP, AAA, sFlow, RSPAN and PTPv2
- Service port for out-of-band Ethernet management (OOB)
- USB Type-C port for local management console (unique NETGEAR driver for M4250/M4350)
- Standard USB-A ports for local storage, logs, configuration or image files
- Industry standard command line interface (CLI) for IT admins used to other vendors commands
- Fully functional Web console (main GUI) for IT admins who prefer an easy to use graphical interface
- Dedicated AV web-based GUI interface for AV installations

NETGEAR M4350 series warranty and support:

- NETGEAR M4350 series is covered under NETGEAR Enterprise Lifetime Warranty*
- 3 years of Sprint support included with 24/5 Technical Support (phone, online) and Advance RMA Replacement
- Overdrive support contracts available for 24/7 Technical Support (phone, online, 2h SLA) and Next Business Day RMA Replacement

Hardware-at-a-Glance

Model Name	Form-Factor	Switching Fabric	FRONT							REAR			MANAGEMENT	Model Number	
			1000BASE-T RJ45 ports	2.5GBASE-T RJ45 ports	10GBASE-T RJ45 ports	2.5GBASE-X SFP ports	10GBASE-X SFP+ ports	25GBASE-X SFP28 ports	100GBASE-X QSFP28 ports	Internal PSU	Modular PSU Bays	Fans			Out-of-band Console
M4350-24G4XF	Full width 1U rack mount 440x43.2x400mm	128 Gbps	24 ports PoE+ 10M; 100M; 1G 648W (base) up to 720W	-	-	-	4 ports 1G; 10G	-	-	1 x Fixed 880W (C14) On/Off switch	1 slot	Fixed Front-to-back	Ethernet: Out-of-band 1G port (Back)	GSM4328	
M4350-48G4XF	Full width 1U rack mount 440x43.2x400mm	176 Gbps	48 ports PoE+ 10M; 100M; 1G 236W (base) up to 1,440W	-	-	-	4 ports 1G; 10G	-	-	1 x Fixed 550W (C14) On/Off switch	2 slots			GSM4352	
M4350-8M2V	Half-width / Color LEDs 1U rack mount 220*43.2*300mm	140 Gbps	-	8 ports PoE++ 100M; 1G; 2.5G 119W (base) up to 551W	-	-	-	2 ports 10G; 25G (Ethernet Mode*) (Stacking: 25G**)	-	-	1 external power adapter included: APS254W (C14) 3 DC connectors for max 3 x APS254W			MSM4310	
M4350-24M4X4V	Full width / Color LEDs 1U rack mount 440*43.2*400mm	400 Gbps	-	24 ports PoE+++ 100M; 1G; 2.5G 119W (base) up to 551W	4 ports PoE+++ 1G; 2.5G; 5G; 10G	-	-	4 ports 10G; 25G (Ethernet Mode*) (Stacking: 25G**)	-	1 x Fixed 800W (C14) On/Off switch	2 slots			Console: USB-C (Front)	MSM4332
M4350-44M4X4V	Full width 1U rack mount 440x43.2x400mm	500 Gbps	-	44 ports PoE+++ 100M; 1G; 2.5G 119W (base) up to 551W	4 ports PoE+++ 1G; 2.5G; 5G; 10G	-	-	4 ports 10G; 25G (Ethernet Mode*) (Stacking: 25G**)	-	1 x Fixed 550W (C14) On/Off switch	2 slots			Storage: 2 x USB-A (Back)	MSM4352
M4350-24F4X	Full width / Color LEDs 1U rack mount 440*43.2*400mm	200 Gbps	-	-	4 ports 100M; 1G; 2.5G; 5G; 10G Combo with the 4xSFP+	24 ports 1G, 2.5G	4 ports 1G, 10G Combo with the 4x10GBASE-T	-	-	1 x Fixed 240W (C14) On/Off switch	1 slot				MSM4328F

* ETHERNET Mode: Each 4 x 25G block is connected to a 100G SERDES. As such, each 4-port block can only work at the same speed: 4x10G, or 4x25G. Since 25G takes precedence, when one 25G module is inserted, other ports with 10G modules get down in the same 4-port block.

** STACKING Mode: Stacking link only works on the highest speed supported by a Stack port. A 25G port, when configured in Stack mode, only operates at 25G. It cannot operate at 10G. Similarly, a 100G port, when configured in Stack mode, only operates at 100G.

*** Ultra90 PoE++ 802.3bt is compatible with 802.3af PoE (15.4W), 802.3at PoE+ (30W) and 802.3bt (60W, 75W and 90W).

Hardware-at-a-Glance

Model Name	Form-Factor	Switching Fabric	FRONT							REAR			MANAGEMENT	Model Number	
			1000BASE-T RJ45 ports	2.5GBASE-T RJ45 ports	10GBASE-T RJ45 ports	2.5GBASE-X SFP ports	10GBASE-X SFP+ ports	25GBASE-X SFP28 ports	100GBASE-X QSFP28 ports	Internal PSU	Modular PSU Bays	Fans			Out-of-band Console
M4350-8X8F	Half-width 1- or 2-unit 1U rack mount 220x43.2x400mm	320 Gbps	-	-	8 ports 100M; 1G; 2.5G; 5G; 10G	-	8 ports 1G (ports 9-12 only); 10G	-	-	-	1 x Fixed 240W (C14) On/Off switch	-	Fixed Front-to-back	Out-of-band Console	XSM4316
M4350-12X12F	Half-width 1- or 2-unit 1U rack mount 220x43.2x400mm	480 Gbps	-	-	12 ports 100M; 1G; 2.5G; 5G; 10G	-	12 ports 1G (ports 13-20 only); 10G	-	-	-	1 x Fixed 240W (C14) On/Off switch	-		Out-of-band Console	XSM4324
M4350-24X4V	Full width 1U rack mount 440x43.2x400mm	680 Gbps	-	-	24 ports PoE+ 100M (ports 1-16 only); 1G; 2.5G; 5G; 10G 576W (base), up to 720W	-	-	4 ports 10G; 25G (Ethernet Mode*) (Stacking: 25G**)	-	-	1 x Fixed 880W (C14) On/Off switch	1 slot		Ethernet: Out-of-band 1G port (Back)	XSM4328CV
M4350-24F4V	Full width 1U rack mount 440x43.2x400mm	680 Gbps	-	-	-	-	24 ports 1G (ports 1-16 only); 10G	4 ports 10G; 25G (Ethernet Mode*) (Stacking: 25G**)	-	-	1 x Fixed 240W (C14) On/Off switch	1 slot		Console: USB-C (Front)	XSM4328FV
M4350-36X4V	Full width 1U rack mount 440x43.2x400mm	920 Gbps	-	-	36 ports PoE++*** 100M (ports 1-28 only); 1G; 2.5G; 5G; 10G 280W (base), up to 1,760W	-	-	4 ports 10G; 25G (Ethernet Mode*) (Stacking: 25G**)	-	-	1 x Fixed 750W (C14) On/Off switch	1 slot		Storage: 2 x USB-A (Back)	XSM4340CV
M4350-24X8F8V	Full width 1U rack mount 440x43.2x400mm	1.04 Tbps	-	-	24 ports PoE++*** 100M; 1G; 2.5G; 5G; 10G 290W (base), up to 1,770W	-	8 ports 1G (ports 25-28 only); 10G	8 ports 10G; 25G (Ethernet Mode*) (Stacking: 25G**)	-	-	1 x Fixed 750W (C14) On/Off switch	1 slot			XSM4340V

* ETHERNET Mode: Each 4 x 25G block is connected to a 100G SERDES. As such, each 4-port block can only work at the same speed: 4x10G, or 4x25G. Since 25G takes precedence, when one 25G module is inserted, other ports with 10G modules get down in the same 4-port block.

** STACKING Mode: Stacking link only works on the highest speed supported by a Stack port. A 25G port, when configured in Stack mode, only operates at 25G. It cannot operate at 10G. Similarly, a 100G port, when configured in Stack mode, only operates at 100G.

*** Ultra90 PoE++ 802.3bt is compatible with 802.3af PoE (15.4W), 802.3at PoE+ (30W) and 802.3bt (60W, 75W and 90W).

Hardware-at-a-Glance

Model Name	Form-Factor	Switching Fabric	FRONT							REAR			MANAGEMENT	Model Number	
			1000BASE-T RJ45 ports	2.5GBASE-T RJ45 ports	10GBASE-T RJ45 ports	2.5GBASE-X SFP ports	10GBASE-X SFP+ ports	25GBASE-X SFP28 ports	100GBASE-X QSFP28 ports	Internal PSU	Modular PSU Bays	Fans			Out-of-band Console
M4350-32F8V	Full width 1U rack mount 440x43.2x400mm	1.04 Tbps	-	-	-	-	-	32 ports 1G (ports 1-28 only); 10G	8 ports 10G; 25G (Ethernet Mode*) (Stacking: 25G**)	-	1 x Fixed 420W (C14) On/Off switch	1 slot	Fixed Front-to-back	Ethernet: Out-of-band 1G port (Back)	XSM4340FV
M4350-16V4C	Full width 1U rack mount 440x43.2x400mm	1.6 Tbps	-	-	-	-	-	-	16 ports 10G; 25G (Ethernet Mode*)	4 ports 40G; 100G (Stacking: 100G**)	1 x Fixed 420W (C14) On/Off switch	1 slot			Console: USB-C (Front)
M4350-40X4C	Full width 1U rack mount 440x43.2x400mm	1.6 Tbps	-	-	40 ports PoE++*** 1G; 2.5G; 5G; 10G 196W (base), up to 1,676W	-	-	-	4 ports 40G; 100G (Stacking: 100G**)	1 x Fixed 750W (C14) On/Off switch	1 slot	Storage: 2 x USB-A (Back)		XSM4344C	
M4350-40F4C	Full width / Color LEDs 1U rack mount 440*43.2*400mm	1.6 Tbps	-	-	-	-	40 ports 10G	-	4 ports 40G; 100G (Stacking: 100G**)	1 x Fixed 420W (C14) On/Off switch	1 slot			XSM4344FC	

* ETHERNET Mode: Each 4 x 25G block is connected to a 100G SERDES. As such, each 4-port block can only work at the same speed: 4x10G, or 4x25G. Since 25G takes precedence, when one 25G module is inserted, other ports with 10G modules get down in the same 4-port block.

** STACKING Mode: Stacking link only works on the highest speed supported by a Stack port. A 25G port, when configured in Stack mode, only operates at 25G. It cannot operate at 10G. Similarly, a 100G port, when configured in Stack mode, only operates at 100G.

*** Ultra90 PoE++ 802.3bt is compatible with 802.3af PoE (15.4W), 802.3at PoE+ (30W) and 802.3bt (60W, 75W and 90W).



RPS+EPS Wattages*-at-a-Glance

Model Name	Internal PSU	Modular PSUs		Switch Operational Without PoE?	Available PoE Budget	Model Number
		PSU Slot 1	PSU Slot 2			
M4350-24G4XF	880W - Connected	Disconnected	-	Yes	648W	GSM4328
APS350W-100NES/AJS	880W - Connected	APS350W	-	Yes	720W	APS350W-100NES/AJS
APS350W-100NES/AJS	Disconnected	APS350W	-	Yes	218W	APS350W-100NES/AJS
APS600W-200NES/AJS	880W - Connected	APS600Wv2	-	Yes	720W	APS600W-200NES/AJS
APS600W-200NES/AJS	Disconnected	APS600Wv2	-	Yes	468W	APS600W-200NES/AJS
APS920W-100NES/AJS	880W - Connected	APS920W	-	Yes	720W	APS920W-100NES/AJS
APS920W-100NES/AJS	Disconnected	APS920W	-	Yes	720W	APS920W-100NES/AJS
APS2000W-100NES/AJS	880W - Connected	APS2000W 110VAC	-	Yes	720W	APS2000W-100NES/AJS
APS2000W-100NES/AJS	Disconnected	APS2000W 110VAC	-	Yes	720W	APS2000W-100NES/AJS
APS2000W-100NES/AJS	880W - Connected	APS2000W 220VAC	-	Yes	720W	APS2000W-100NES/AJS
APS2000W-100NES/AJS	Disconnected	APS2000W 220VAC	-	Yes	720W	APS2000W-100NES/AJS
M4350-48G4XF	550W - Connected	Disconnected	Disconnected	Yes	236W	GSM4352
APS350W-100NES/AJS	550W - Connected	APS350W	Disconnected	Yes	436W	APS350W-100NES/AJS
APS350W-100NES/AJS	Disconnected	APS350W	Disconnected	Yes	186W	APS350W-100NES/AJS
APS600W-200NES/AJS	550W - Connected	APS600Wv2	Disconnected	Yes	636W	APS600W-200NES/AJS
APS600W-200NES/AJS	Disconnected	APS600Wv2	Disconnected	Yes	436W	APS600W-200NES/AJS
APS920W-100NES/AJS	550W - Connected	APS920W	Disconnected	Yes	892W	APS920W-100NES/AJS
APS920W-100NES/AJS	Disconnected	APS920W	Disconnected	Yes	756W	APS920W-100NES/AJS
APS2000W-100NES/AJS	550W - Connected	APS2000W 110VAC	Disconnected	Yes	956W	APS2000W-100NES/AJS
APS2000W-100NES/AJS	Disconnected	APS2000W 110VAC	Disconnected	Yes	836W	APS2000W-100NES/AJS
APS2000W-100NES/AJS	550W - Connected	APS2000W 220VAC	Disconnected	Yes	1,440W	APS2000W-100NES/AJS
APS2000W-100NES/AJS	Disconnected	APS2000W 220VAC	Disconnected	Yes	1,440W	APS2000W-100NES/AJS
M4350-48G4XF	550W - Connected	Disconnected	Disconnected	Yes	236W	GSM4352
APS350W-100NES/AJS	550W - Connected	APS350W	APS350W	Yes	716W	APS350W-100NES/AJS
APS350W-100NES/AJS	Disconnected	APS350W	APS350W	Yes	396W	APS350W-100NES/AJS
APS600W-200NES/AJS	550W - Connected	APS600Wv2	APS600Wv2	Yes	1,116W	APS600W-200NES/AJS
APS600W-200NES/AJS	Disconnected	APS600Wv2	APS600Wv2	Yes	796W	APS600W-200NES/AJS
APS920W-100NES/AJS	550W - Connected	APS920W	APS920W	Yes	1,440W	APS920W-100NES/AJS
APS920W-100NES/AJS	Disconnected	APS920W	APS920W	Yes	1,308W	APS920W-100NES/AJS
APS2000W-100NES/AJS	550W - Connected	APS2000W 110VAC	APS2000W 110VAC	Yes	1,440W	APS2000W-100NES/AJS
APS2000W-100NES/AJS	Disconnected	APS2000W 110VAC	APS2000W 110VAC	Yes	1,436W	APS2000W-100NES/AJS
APS2000W-100NES/AJS	550W - Connected	APS2000W 220VAC	APS2000W 220VAC	Yes	1,440W	APS2000W-100NES/AJS
APS2000W-100NES/AJS	Disconnected	APS2000W 220VAC	APS2000W 220VAC	Yes	1,440W	APS2000W-100NES/AJS

RPS+EPS Wattages*-at-a-Glance

Model Name	Internal PSU	Modular PSUs		Switch Operational Without PoE?	Available PoE Budget	Model Number
		PSU Slot 1	PSU Slot 2			
M4350-8M2V	APS254W - Connected	Disconnected	-	Yes	119W	MSM4310
APS254W-10000S	APS254W - Connected	APS254W	-	Yes	322W	APS254W-10000S
APS254W-10000S	Disconnected	APS254W	-	Yes	119W	APS254W-10000S
M4350-8M2V	APS254W - Connected	Disconnected	Disconnected	Yes	119W	MSM4310
APS254W-10000S	APS254W - Connected	APS254W	APS254W	Yes	551W	APS254W-10000S
APS254W-10000S	Disconnected	APS254W	APS254W	Yes	322W	APS254W-10000S
M4350-24M4X4V	800W - Connected	Disconnected	-	Yes	522W	MSM4332
APS600W-300NES/AJS	800W - Connected	APS600Wv3	-	Yes	852W	APS600W-300NES/AJS
APS600W-300NES/AJS	Disconnected	APS600Wv3	-	Yes	372W	APS600W-300NES/AJS
APS1200W-200NES/AJS	800W - Connected	APS1200Wv2 110VAC	-	Yes	1,172W	APS1200W-200NES/AJS
APS1200W-200NES/AJS	Disconnected	APS1200Wv2 110VAC	-	Yes	772W	APS1200W-200NES/AJS
APS1200W-200NES/AJS	800W - Connected	APS1200Wv2 220VAC	-	Yes	1332W	APS1200W-200NES/AJS
APS1200W-200NES/AJS	Disconnected	APS1200Wv2 220VAC	-	Yes	972W	APS1200W-200NES/AJS
APS2000W-200NES/AJS	800W - Connected	APS2000Wv2 110VAC	-	Yes	1,172W	APS2000W-200NES/AJS
APS2000W-200NES/AJS	Disconnected	APS2000Wv2 110VAC	-	Yes	772W	APS2000W-200NES/AJS
APS2000W-200NES/AJS	800W - Connected	APS2000Wv2 220VAC	-	Yes	1,972W	APS2000W-200NES/AJS
APS2000W-200NES/AJS	Disconnected	APS2000Wv2 220VAC	-	Yes	1,772W	APS2000W-200NES/AJS
M4350-24M4X4V	800W - Connected	Disconnected	-	Yes	522W	MSM4332
APS600W-300NES/AJS	800W - Connected	APS600Wv3	APS600Wv3	Yes	1,332W	APS600W-300NES/AJS
APS600W-300NES/AJS	Disconnected	APS600Wv3	APS600Wv3	Yes	732W	APS600W-300NES/AJS
APS1200W-200NES/AJS	800W - Connected	APS1200Wv2 110VAC	APS1200Wv2 110VAC	Yes	1,972W	APS1200W-200NES/AJS
APS1200W-200NES/AJS	Disconnected	APS1200Wv2 110VAC	APS1200Wv2 110VAC	Yes	1,372W	APS1200W-200NES/AJS
APS1200W-200NES/AJS	800W - Connected	APS1200Wv2 220VAC	APS1200Wv2 220VAC	Yes	2,292W	APS1200W-200NES/AJS
APS1200W-200NES/AJS	Disconnected	APS1200Wv2 220VAC	APS1200Wv2 220VAC	Yes	1,692W	APS1200W-200NES/AJS
APS2000W-200NES/AJS	800W - Connected	APS2000Wv2 110VAC	APS2000Wv2 110VAC	Yes	1,972W	APS2000W-200NES/AJS
APS2000W-200NES/AJS	Disconnected	APS2000Wv2 110VAC	APS2000Wv2 110VAC	Yes	1,372W	APS2000W-200NES/AJS
APS2000W-200NES/AJS	800W - Connected	APS2000Wv2 220VAC	APS2000Wv2 220VAC	Yes	2,520W	APS2000W-200NES/AJS
APS2000W-200NES/AJS	Disconnected	APS2000Wv2 220VAC	APS2000Wv2 220VAC	Yes	2,520W	APS2000W-200NES/AJS

RPS+EPS Wattages*-at-a-Glance

Model Name	Internal PSU	Modular PSUs		Switch Operational Without PoE?	Available PoE Budget	Model Number
		PSU Slot 1	PSU Slot 2			
M4350-44M4X4V	550W - Connected	Disconnected	Disconnected	Yes	194W	MSM4352
APS350W-100NES/AJS	550W - Connected	APS350W	Disconnected	Yes	394W	APS350W-100NES/AJS
APS350W-100NES/AJS	Disconnected	APS350W	Disconnected	Yes	144W	APS350W-100NES/AJS
APS600W-200NES/AJS	550W - Connected	APS600Wv2	Disconnected	Yes	594W	APS600W-200NES/AJS
APS600W-200NES/AJS	Disconnected	APS600Wv2	Disconnected	Yes	394W	APS600W-200NES/AJS
APS920W-100NES/AJS	550W - Connected	APS920W	Disconnected	Yes	850W	APS920W-100NES/AJS
APS920W-100NES/AJS	Disconnected	APS920W	Disconnected	Yes	714W	APS920W-100NES/AJS
APS2000W-100NES/AJS	550W - Connected	APS2000W 110VAC	Disconnected	Yes	914W	APS2000W-100NES/AJS
APS2000W-100NES/AJS	Disconnected	APS2000W 110VAC	Disconnected	Yes	794W	APS2000W-100NES/AJS
APS2000W-100NES/AJS	550W - Connected	APS2000W 220VAC	Disconnected	Yes	1,786W	APS2000W-100NES/AJS
APS2000W-100NES/AJS	Disconnected	APS2000W 220VAC	Disconnected	Yes	1,694W	APS2000W-100NES/AJS
M4350-44M4X4V	550W - Connected	Disconnected	Disconnected	Yes	194W	MSM4352
APS350W-100NES/AJS	550W - Connected	APS350W	APS350W	Yes	674W	APS350W-100NES/AJS
APS350W-100NES/AJS	Disconnected	APS350W	APS350W	Yes	354W	APS350W-100NES/AJS
APS600W-200NES/AJS	550W - Connected	APS600Wv2	APS600Wv2	Yes	1,074W	APS600W-200NES/AJS
APS600W-200NES/AJS	Disconnected	APS600Wv2	APS600Wv2	Yes	754W	APS600W-200NES/AJS
APS920W-100NES/AJS	550W - Connected	APS920W	APS920W	Yes	1,586W	APS920W-100NES/AJS
APS920W-100NES/AJS	Disconnected	APS920W	APS920W	Yes	1,266W	APS920W-100NES/AJS
APS2000W-100NES/AJS	550W - Connected	APS2000W 110VAC	APS2000W 110VAC	Yes	1,714W	APS2000W-100NES/AJS
APS2000W-100NES/AJS	Disconnected	APS2000W 110VAC	APS2000W 110VAC	Yes	1,394W	APS2000W-100NES/AJS
APS2000W-100NES/AJS	550W - Connected	APS2000W 220VAC	APS2000W 220VAC	Yes	3,314W	APS2000W-100NES/AJS
APS2000W-100NES/AJS	Disconnected	APS2000W 220VAC	APS2000W 220VAC	Yes	2,994W	APS2000W-100NES/AJS
M4350-24F4X	240W - Connected	Disconnected	-	Yes	-	MSM4328F
APS600W-300NES/AJS	240W - Connected	APS600Wv3	-	Yes	-	APS600W-300NES/AJS
APS600W-300NES/AJS	Disconnected	APS600Wv3	-	Yes	-	APS600W-300NES/AJS
APS1200W-200NES/AJS	240W - Connected	APS1200Wv2 110VAC	-	Yes	-	APS1200W-200NES/AJS
APS1200W-200NES/AJS	Disconnected	APS1200Wv2 110VAC	-	Yes	-	APS1200W-200NES/AJS
APS1200W-200NES/AJS	240W - Connected	APS1200Wv2 220VAC	-	Yes	-	APS1200W-200NES/AJS
APS1200W-200NES/AJS	Disconnected	APS1200Wv2 220VAC	-	Yes	-	APS1200W-200NES/AJS
APS2000W-200NES/AJS	240W - Connected	APS2000Wv2 110VAC	-	Yes	-	APS2000W-200NES/AJS
APS2000W-200NES/AJS	Disconnected	APS2000Wv2 110VAC	-	Yes	-	APS2000W-200NES/AJS
APS2000W-200NES/AJS	240W - Connected	APS2000Wv2 220VAC	-	Yes	-	APS2000W-200NES/AJS
APS2000W-200NES/AJS	Disconnected	APS2000Wv2 220VAC	-	Yes	-	APS2000W-200NES/AJS

RPS+EPS Wattages*-at-a-Glance

Model Name	Internal PSU	Modular PSUs		Switch Operational Without PoE?	Available PoE Budget	Model Number
		PSU Slot 1	PSU Slot 2			
M4350-24X4V	880W - Connected	Disconnected	-	Yes	576W	XSM4328CV
APS350W-100NES/AJS	880W - Connected	APS350W	-	Yes	700W	APS350W-100NES/AJS
APS350W-100NES/AJS	Disconnected	APS350W	-	Yes	146W	APS350W-100NES/AJS
APS600W-200NES/AJS	880W - Connected	APS600Wv2	-	Yes	720W	APS600W-200NES/AJS
APS600W-200NES/AJS	Disconnected	APS600Wv2	-	Yes	396W	APS600W-200NES/AJS
APS920W-100NES/AJS	880W - Connected	APS920W	-	Yes	720W	APS920W-100NES/AJS
APS920W-100NES/AJS	Disconnected	APS920W	-	Yes	716W	APS920W-100NES/AJS
APS2000W-100NES/AJS	880W - Connected	APS2000W 110VAC	-	Yes	720W	APS2000W-100NES/AJS
APS2000W-100NES/AJS	Disconnected	APS2000W 110VAC	-	Yes	720W	APS2000W-100NES/AJS
APS2000W-100NES/AJS	880W - Connected	APS2000W 220VAC	-	Yes	720W	APS2000W-100NES/AJS
APS2000W-100NES/AJS	Disconnected	APS2000W 220VAC	-	Yes	720W	APS2000W-100NES/AJS
M4350-24F4V	240W - Connected	Disconnected	-	Yes	-	XSM4328FV
APS350W-100NES/AJS	240W - Connected	APS350W	-	Yes	-	APS350W-100NES/AJS
APS350W-100NES/AJS	Disconnected	APS350W	-	Yes	-	APS350W-100NES/AJS
APS600W-200NES/AJS	240W - Connected	APS600Wv2	-	Yes	-	APS600W-200NES/AJS
APS600W-200NES/AJS	Disconnected	APS600Wv2	-	Yes	-	APS600W-200NES/AJS
APS920W-100NES/AJS	240W - Connected	APS920W	-	Yes	-	APS920W-100NES/AJS
APS920W-100NES/AJS	Disconnected	APS920W	-	Yes	-	APS920W-100NES/AJS
APS2000W-100NES/AJS	240W - Connected	APS2000W 110VAC	-	Yes	-	APS2000W-100NES/AJS
APS2000W-100NES/AJS	Disconnected	APS2000W 110VAC	-	Yes	-	APS2000W-100NES/AJS
APS2000W-100NES/AJS	240W - Connected	APS2000W 220VAC	-	Yes	-	APS2000W-100NES/AJS
APS2000W-100NES/AJS	Disconnected	APS2000W 220VAC	-	Yes	-	APS2000W-100NES/AJS
M4350-36X4V	750W - Connected	Disconnected	-	Yes	280W	XSM4340CV
APS600W-300NES/AJS	750W - Connected	APS600Wv3	-	Yes	640W	APS600W-300NES/AJS
APS600W-300NES/AJS	Disconnected	APS600Wv3	-	Yes	280W	APS600W-300NES/AJS
APS1200W-200NES/AJS	750W - Connected	APS1200Wv2 110VAC	-	Yes	960W	APS1200W-200NES/AJS
APS1200W-200NES/AJS	Disconnected	APS1200Wv2 110VAC	-	Yes	680W	APS1200W-200NES/AJS
APS1200W-200NES/AJS	750W - Connected	APS1200Wv2 220VAC	-	Yes	1,120W	APS1200W-200NES/AJS
APS1200W-200NES/AJS	Disconnected	APS1200Wv2 220VAC	-	Yes	880W	APS1200W-200NES/AJS
APS2000W-200NES/AJS	750W - Connected	APS2000Wv2 110VAC	-	Yes	960W	APS2000W-200NES/AJS
APS2000W-200NES/AJS	Disconnected	APS2000Wv2 110VAC	-	Yes	680W	APS2000W-200NES/AJS
APS2000W-200NES/AJS	750W - Connected	APS2000Wv2 220VAC	-	Yes	1,760W	APS2000W-200NES/AJS
APS2000W-200NES/AJS	Disconnected	APS2000Wv2 220VAC	-	Yes	1,680W	APS2000W-200NES/AJS

RPS+EPS Wattages*-at-a-Glance

Model Name	Internal PSU	Modular PSUs		Switch Operational Without PoE?	Available PoE Budget	Model Number
		PSU Slot 1	PSU Slot 2			
M4350-24X8F8V	750W - Connected	Disconnected	-	Yes	290W	XSM4340V
APS600W-300NES/AJS	750W - Connected	APS600Wv3	-	Yes	650W	APS600W-300NES/AJS
APS600W-300NES/AJS	Disconnected	APS600Wv3	-	Yes	290W	APS600W-300NES/AJS
APS1200W-200NES/AJS	750W - Connected	APS1200Wv2 110VAC	-	Yes	970W	APS1200W-200NES/AJS
APS1200W-200NES/AJS	Disconnected	APS1200Wv2 110VAC	-	Yes	690W	APS1200W-200NES/AJS
APS1200W-200NES/AJS	750W - Connected	APS1200Wv2 220VAC	-	Yes	1,130W	APS1200W-200NES/AJS
APS1200W-200NES/AJS	Disconnected	APS1200Wv2 220VAC	-	Yes	890W	APS1200W-200NES/AJS
APS2000W-200NES/AJS	750W - Connected	APS2000Wv2 110VAC	-	Yes	970W	APS2000W-200NES/AJS
APS2000W-200NES/AJS	Disconnected	APS2000Wv2 110VAC	-	Yes	690W	APS2000W-200NES/AJS
APS2000W-200NES/AJS	750W - Connected	APS2000Wv2 220VAC	-	Yes	1,770W	APS2000W-200NES/AJS
APS2000W-200NES/AJS	Disconnected	APS2000Wv2 220VAC	-	Yes	1,690W	APS2000W-200NES/AJS
M4350-32F8V	420W - Connected	Disconnected	-	Yes	-	XSM4340FV
APS600W-300NES/AJS	420W - Connected	APS600Wv3	-	Yes	-	APS600W-300NES/AJS
APS600W-300NES/AJS	Disconnected	APS600Wv3	-	Yes	-	APS600W-300NES/AJS
APS1200W-200NES/AJS	420W - Connected	APS1200Wv2 110VAC	-	Yes	-	APS1200W-200NES/AJS
APS1200W-200NES/AJS	Disconnected	APS1200Wv2 110VAC	-	Yes	-	APS1200W-200NES/AJS
APS1200W-200NES/AJS	420W - Connected	APS1200Wv2 220VAC	-	Yes	-	APS1200W-200NES/AJS
APS1200W-200NES/AJS	Disconnected	APS1200Wv2 220VAC	-	Yes	-	APS1200W-200NES/AJS
APS2000W-200NES/AJS	420W - Connected	APS2000Wv2 110VAC	-	Yes	-	APS2000W-200NES/AJS
APS2000W-200NES/AJS	Disconnected	APS2000Wv2 110VAC	-	Yes	-	APS2000W-200NES/AJS
APS2000W-200NES/AJS	420W - Connected	APS2000Wv2 220VAC	-	Yes	-	APS2000W-200NES/AJS
APS2000W-200NES/AJS	Disconnected	APS2000Wv2 220VAC	-	Yes	-	APS2000W-200NES/AJS
M4350-16V4C	420W - Connected	Disconnected	-	Yes	-	VSM4320C
APS600W-300NES/AJS	420W - Connected	APS600Wv3	-	Yes	-	APS600W-300NES/AJS
APS600W-300NES/AJS	Disconnected	APS600Wv3	-	Yes	-	APS600W-300NES/AJS
APS1200W-200NES/AJS	420W - Connected	APS1200Wv2 110VAC	-	Yes	-	APS1200W-200NES/AJS
APS1200W-200NES/AJS	Disconnected	APS1200Wv2 110VAC	-	Yes	-	APS1200W-200NES/AJS
APS1200W-200NES/AJS	420W - Connected	APS1200Wv2 220VAC	-	Yes	-	APS1200W-200NES/AJS
APS1200W-200NES/AJS	Disconnected	APS1200Wv2 220VAC	-	Yes	-	APS1200W-200NES/AJS
APS2000W-200NES/AJS	420W - Connected	APS2000Wv2 110VAC	-	Yes	-	APS2000W-200NES/AJS
APS2000W-200NES/AJS	Disconnected	APS2000Wv2 110VAC	-	Yes	-	APS2000W-200NES/AJS
APS2000W-200NES/AJS	420W - Connected	APS2000Wv2 220VAC	-	Yes	-	APS2000W-200NES/AJS
APS2000W-200NES/AJS	Disconnected	APS2000Wv2 220VAC	-	Yes	-	APS2000W-200NES/AJS

* M4350 full width switches offer RPS (redundant power supply) and EPS (extended power supply) modes at the same time, automatically. This table explains the total PoE budget (EPS), and the protected PoE budget (RPS) for each combination of PSU.

RPS+EPS Wattages*-at-a-Glance

Model Name	Internal PSU	Modular PSUs		Switch Operational Without PoE?	Available PoE Budget	Model Number
		PSU Slot 1	PSU Slot 2			
M4350-40X4C	750W - Connected	Disconnected	-	Yes	196W	XSM4344C
APS600W-300NES/AJS	750W - Connected	APS600Wv3	-	Yes	556W	APS600W-300NES/AJS
APS600W-300NES/AJS	Disconnected	APS600Wv3	-	Yes	196W	APS600W-300NES/AJS
APS1200W-200NES/AJS	750W - Connected	APS1200Wv2 110VAC	-	Yes	876W	APS1200W-200NES/AJS
APS1200W-200NES/AJS	Disconnected	APS1200Wv2 110VAC	-	Yes	596W	APS1200W-200NES/AJS
APS1200W-200NES/AJS	750W - Connected	APS1200Wv2 220VAC	-	Yes	1,036W	APS1200W-200NES/AJS
APS1200W-200NES/AJS	Disconnected	APS1200Wv2 220VAC	-	Yes	796W	APS1200W-200NES/AJS
APS2000W-200NES/AJS	750W - Connected	APS2000Wv2 110VAC	-	Yes	876W	APS2000W-200NES/AJS
APS2000W-200NES/AJS	Disconnected	APS2000Wv2 110VAC	-	Yes	596W	APS2000W-200NES/AJS
APS2000W-200NES/AJS	750W - Connected	APS2000Wv2 220VAC	-	Yes	1,676W	APS2000W-200NES/AJS
APS2000W-200NES/AJS	Disconnected	APS2000Wv2 220VAC	-	Yes	1,596W	APS2000W-200NES/AJS
M4350-40F4C	420W - Connected	Disconnected	-	Yes	-	XSM4344FC
APS600W-300NES/AJS	420W - Connected	APS600Wv3	-	Yes	-	APS600W-300NES/AJS
APS600W-300NES/AJS	Disconnected	APS600Wv3	-	Yes	-	APS600W-300NES/AJS
APS1200W-200NES/AJS	420W - Connected	APS1200Wv2 110VAC	-	Yes	-	APS1200W-200NES/AJS
APS1200W-200NES/AJS	Disconnected	APS1200Wv2 110VAC	-	Yes	-	APS1200W-200NES/AJS
APS1200W-200NES/AJS	420W - Connected	APS1200Wv2 220VAC	-	Yes	-	APS1200W-200NES/AJS
APS1200W-200NES/AJS	Disconnected	APS1200Wv2 220VAC	-	Yes	-	APS1200W-200NES/AJS
APS2000W-200NES/AJS	420W - Connected	APS2000Wv2 110VAC	-	Yes	-	APS2000W-200NES/AJS
APS2000W-200NES/AJS	Disconnected	APS2000Wv2 110VAC	-	Yes	-	APS2000W-200NES/AJS
APS2000W-200NES/AJS	420W - Connected	APS2000Wv2 220VAC	-	Yes	-	APS2000W-200NES/AJS
APS2000W-200NES/AJS	Disconnected	APS2000Wv2 220VAC	-	Yes	-	APS2000W-200NES/AJS

* M4350 full width switches offer RPS (redundant power supply) and EPS (extended power supply) modes at the same time, automatically. This table explains the total PoE budget (EPS), and the protected PoE budget (RPS) for each combination of PSU.

Acoustic-at-a-Glance

Model Name	QUIET MODE Setting at ambient* (Default mode)					COOL MODE Setting at ambient*			
	PoE Power Load	Fan Duty	Ambient	Case Temp (Top)	Acoustic	Fan Duty	Case Temp (Top)	Acoustic	Model Number
M4350-24G4XF	720W	28	25°C	33.1°C	33dBA	60	31.9°C	52dBA	GSM4328
	720W	60	45°C	48.2°C	52dBA				
M4350-48G4XF	1,440W	28	25°C	33.4°C	33dBA	60	31.3°C	52dBA	GSM4352
	1,440W	60	45°C	48.5°C	52dBA				
M4350-8M2V	551W	32	25°C	47.6°C	32.2dBA	100	28.3°C	59.4dBA	MSM4310
	551W	65	45°C	56.9°C	51.2 dBA				
M4350-24M4X4V	2,520W	30	25°C	29.4°C	34.8 dBA	100	27.3°C	66dBA	MSM4332
	2,520W	60	45°C	47.3°C	51.5 dBA				
M4350-44M4X4V	3,314W	28	25°C	43.3°C	34dBA	60	38.3°C	52dBA	MSM4352
	3,314W	60	45°C	50.1°C	52dBA				
M4350-24F4X	N/A	25	25°C	33.6°C	30dBA	100	28°C	66.9dBA	MSM4328F
	N/A	70	50°C	54.4°C	58.8dBA				
M4350-8X8F	N/A	27	25°C	34.4°C	34.43dBA	70	30.3°C	56.3dBA	XSM4316
	N/A	70	50°C	51.7°C	56.3dBA				
M4350-12X12F	N/A	27	25°C	31.9°C	34.34dBA	100	29.5°C	64dBA	XSM4324
	N/A	100	50°C	51.5°C	64dBA				
M4350-24X4V	720W	30	25°C	32.3°C	34.7dBA	70	29.6°C	57.2dBA	XSM4328CV
	720W	70	45°C	46.6°C	57.2dBA				

* dBA values are SPL (Sound Pressure Level) values, testing following the ISO-7779 standard. Bystander Mode. Chamber Temp 25°C during testing unless noted otherwise. Full, 100%, Data and PoE loaded. Worst case.

For QUIET MODE, Min conditions are: Lowest fan duty when ambient temperature is 25°C, all ports used, max traffic, max PoE budget (additional PSUs). Worst case.

For QUIET MODE, Max conditions are: Highest fan duty when ambient temperature is 45°C (PoE models) or 50°C (non-PoE models), all ports used, max traffic, max PoE budget (additional PSUs) (if applicable). Worst case.

Acoustic-at-a-Glance

Model Name	QUIET MODE Setting at ambient* (Default mode)					COOL MODE Setting at ambient*			
	PoE Power Load	Fan Duty	Ambient	Case Temp (Top)	Acoustic	Fan Duty	Case Temp (Top)	Acoustic	Model Number
M4350-24F4V	N/A	30	25°C	34.2°C	34.2dBA	85	30.3°C	61.8dBA	XSM4328FV
	N/A	85	50°C	52.4°C	61.8dBA				
M4350-36X4V	1760W	25	25°C	39°C	32.1dBA	60	30.4°C	54dBA	XSM4340CV
	1760W	60	45°C	49.2°C	54dBA				
M4350-24X8F8V	1770W	25	25°C	39.9°C	32.6dBA	60	31°C	53.3dBA	XSM4340V
	1770W	60	45°C	48.5°C	53.3dBA				
M4350-32F8V	N/A	25	25°C	35°C	32.7dBA	80	28.9°C	63dBA	XSM4340FV
	N/A	80	50°C	52.1°C	63dBA				
M4350-16V4C	N/A	28	25°C	38.2°C	36.4dBA	60	30.8°C	55dBA	VSM4320C
	N/A	60	45°C	56°C	55dBA				
M4350-40X4C	1676W	25	25°C	39.9°C	34.1dBA	60	33.9°C	54.3dBA	XSM4344C
	1676W	60	45°C	49.6°C	54.3dBA				
M4350-40F4C	N/A	25	25°C	34.9°C	34dBA	100	28.3°C	69.5dBA	XSM4344FC
	N/A	60	45°C	51.7°C	55dBA				

* dBA values are SPL (Sound Pressure Level) values, testing following the ISO-7779 standard. Bystander Mode. Chamber Temp 25°C during testing unless noted otherwise. Full, 100%, Data and PoE loaded. Worst case.

For QUIET MODE, Min conditions are: Lowest fan duty when ambient temperature is 25°C, all ports used, max traffic, max PoE budget (additional PSUs). Worst case.

For QUIET MODE, Max conditions are: Highest fan duty when ambient temperature is 45°C (PoE models) or 50°C (non-PoE models), all ports used, max traffic, max PoE budget (additional PSUs) (if applicable). Worst case.

Software-at-a-Glance

Model Name	Management	LAYER 3 PACKAGE*									Model Number
		IPv4 / IPv6 ACL and QoS, DiffServ	IPv4 / IPv6 Multicast Filtering	IPv4 / IPv6 Policing and Convergence	Spanning Tree Green Ethernet	VLANs	Trunking Port Channel	IPv4 / IPv6 Authentication Security	IPv4 / IPv6 Static Routing	IPv4 / IPv6 Dynamic Routing	
M4350 series	Out-of-band IT Web GUI (main) HTTPs CLI; Telnet; SSH Stacking** NSF with Hitless Failover SNMP, MIBs RSPAN Radius Users, TACACS	Ingress/egress 1 Kbps shaping Time-based Single Rate Policing	NETGEAR IGMP™ Plus for automated IGMP between switches IGMPv3 MLDv2 Snooping, Proxy ASM & SSM IGMPv1,v2 Querier (compatible v3) Control Packet Flooding	Auto-VoIP Policy-based routing (PBR) LLDP-MED IEEE 1588 PTPv2 1-Step End-to-End Transparent Clock (TC) AVB: 802.1AS, 802.1Qav, 802.1Qat MSRP, 802.1ak MMRP, 802.1ak MVRP	STP, MTP, RSTP PV(R)STP BPDU/STRG Root Guard EEE 802.3az (EEE is disabled by default)	Static, Dynamic, Voice, MAC GVRP/GMRP Double VLAN mode Private VLANs	Auto-Trunk and Auto-LAG between M4250, M4300, and M4350 Switches Static LAG, or Dynamic LACP (LACP automatically reverts to and from Static LAG) Seven (7) L2/L3/L4 hashing algorithm	Successive Tiering (DOT1X; MAB; Captive Portal) DHCP Snooping Dynamic ARP Inspection IP Source Guard	Port, Subnet, VLAN routing Multicast static routes DHCPv4 Server DHCP Relay Stateful DHCPv6 Server	IPv4: RIP, VRRP IPv4/IPv6: OSPF, Proxy ARP, PIM-SM, PIM-DM, SSM	All models
M4350-8M2V M4350-24M4X4V M4350-24F4X M4350-16V4C M4350-40X4C M4350-40F4C											MSM4310 MSM4332 MSM4328F VSM4320C XSM4344C XSM4344FC

* All software features are available, license-free.

** Stacking, AVB, and PTP TC are mutually exclusive features. A stack cannot run AVB, nor PTP TC (or BC/GM)



Performance-at-a-Glance

TABLE SIZE														
Model Name	MAC ARP/NDP	Routing / Switching Capacity	Throughput 64-byte	Application Route Scaling	Packet Buffer	Latency 64-byte	DDR4 RAM	CPU	IP Multicast Routing Entries	Jumbo Frames	Multicast IGMP Group Membership	VLANs	DHCP	Model Number
M4350-24G4XF	16K MAC 4K ARP/ 512 NDP	128 Gbps Line-Rate	95.23 Mpps	Static: 256v4/64v6 RIP: 512 OSPF: 1,024	16Mb	<2.42µs 1G <0.92µs 10G fiber	2 GB	Quad-Core Cortex-A57 ARMv8 1.8Ghz 64-bit	512 IPv4 256 IPv6	Up to 12K	2K IPv4 2K IPv6	4K VLANs	DHCP Server: 2K leases IPv4: 256 pools IPv6: 16 pools	GSM4328
M4350-48G4XF	16K MAC 4K ARP/ 512 NDP	176 Gbps Line-Rate	130.94 Mpps		32Mb	<2.20µs 1G <0.70µs 10G fiber	2 GB							GSM4352
M4350-8M2V	16K MAC 4K ARP/ 512 NDP	140 Gbps Line-Rate	104.16 Mpps		32Mb	<5.50µs 2.5G <0.70µs @ 10G fiber <0.64µs@ 25G	4 GB							MSM4310
M4350-24M4X4V	16K MAC 4K ARP/ 512 NDP	400 Gbps Line-Rate	297.6 Mpps		32Mb	<5.50µs 2.5G <2.28µs @ 10G copper <0.65µs@ 25G	4 GB							MSM4332
M4350-44M4X4V	16K MAC 4K ARP/ 512 NDP	500 Gbps Line-Rate	372 Mpps		32Mb	<5.61µs 2.5G <2.27µs 10G copper <0.75µs 25G	2 GB							MSM4352
M4350-24F4X	"16K MAC 4K ARP/ 512 NDP"	"200 Gbps Line-Rate"	148.8 Mpps		32Mb	"<1.25µs 1G <2.24µs 10G copper <0.98µs 10G fiber"	4 GB							MSM4328F
M4350-8X8F	16K MAC 4K ARP/ 512 NDP	320 Gbps Line-Rate	238.08 Mpps		32Mb	<2.28µs 1G <2.39µs 10G copper <0.83µs 10G fiber	2 GB							XSM4316
M4350-12X12F	16K MAC 4K ARP/ 512 NDP	480 Gbps Line-Rate	357.12 Mpps		32Mb	<2.14µs 1G <2.29µs 10G copper <0.72µs 10G fiber	2 GB							XSM4324
M4350-24X4V	16K MAC 4K ARP/ 512 NDP	680 Gbps Line-Rate	505.92 Mpps		32Mb	<2.43µs 1G <2.20µs 10G copper <0.97µs 25G	2 GB							XSM4328CV
M4350-24F4V	16K MAC 4K ARP/ 512 NDP	680 Gbps Line-Rate	505.92 Mpps		32Mb	<1.06µs 1G <0.63µs 10G fiber <0.67µs 25G	2 GB							XSM4328FV
M4350-36X4V	16K MAC 4K ARP/ 512 NDP	920 Gbps Line-Rate	684.48 Mpps		64Mb	<2.54µs 1G <2.75µs 10G copper <1.08µs 25G	4 GB							XSM4340CV
M4350-24X8F8V	16K MAC 4K ARP/ 512 NDP	1.04 Tbps Line-Rate	773.76 Mpps		64Mb	<2.7µs 10G copper <1.27µs 10G fiber <1.09µs 25G	4 GB							XSM4340V
M4350-32F8V	16K MAC 4K ARP/ 512 NDP	1.04 Tbps Line-Rate	773.76 Mpps		64Mb	<1.27µs 10G fiber <1.08µs 25G	4 GB							XSM4340FV
M4350-16V4C	16K MAC 4K ARP/ 512 NDP	1.6 Tbps Line-Rate	1190.4 Mpps		256Mb	<2.71µs 10G fiber <1.08µs 25G <1.13µs 100G	4 GB							VSM4320C
M4350-40X4C	16K MAC 4K ARP/ 512 NDP	1.6 Tbps Line-Rate	1190.4 Mpps		256Mb	<2.71µs 10G copper <1.08µs 25G fiber <1.04µs 100G	4 GB							XSM4344C
M4350-40F4C	16K MAC 4K ARP/ 512 NDP	1.6 Tbps Line-Rate	1190.4 Mpps	256Mb	<1.83µs 1G fiber <1.20µs 10G fiber <1.30µs 100G	4 GB	XSM4344FC							

Components

M4350-24G4XF

Fully Managed Switch

Ordering information

- Americas, Europe: GSM4328-100NES (NA, UK, EU)
- Asia Pacific: GSM4328-100AJS (JP, AU)
- China: GSM4328-100PRS
- Warranty: Lifetime ProSAFE Hardware Warranty



PSU Ordering information

- APS350W-100NES (NA, UK, EU)/ -100AJS (JP, AU)/ -10000S (no power cord)
- APS600W-200NES (NA, UK, EU)/ -200AJS (JP, AU)/ -20000S (no power cord)
- APS920W-100NES (NA, UK, EU)/ -100AJS (JP, AU)/ -10000S (no power cord)
- APS2000W-100NES (NA, UK, EU)/ -100AJS (JP, AU)/ -10000S (no power cord)

- 24 Gigabit PoE+ ports with 4 10GBASE-X SFP+ uplinks.
- 880W internal power supply providing 648W of PoE budget.
- 1 slot for modular power supply (1+1 redundancy and/or EPS share).
- Any APS350W, APS600Wv2, APS920W, or APS2000W can be used.
- The PoE budget can reach 720W, when the redundant PoE budget remains 648W.
- Virtual Chassis stacking provides non-stop forwarding (NSF) and hitless failover.
- Layer 3 feature set includes static, policy-based, and dynamic routing.
- NETGEAR IT Web User Interface, speed up Campus IT installations.
- NETGEAR ProSAFE® Limited Lifetime Hardware Warranty.
- Lifetime Next Business Day Hardware Replacement.
- Dimensions: 440*400*43.2 mm
- Weight: 6.41Kg (14.13 lb)



Components

M4350-48G4XF

Fully Managed Switch

Ordering information

- Americas, Europe: GSM4352-100NES (NA, UK, EU)
- Asia Pacific: GSM4352-100AJS (JP, AU)
- China: GSM4352-100PRS
- Warranty: Lifetime ProSAFE Hardware Warranty



PSU Ordering information

- APS350W-100NES (NA, UK, EU)/ -100AJS (JP, AU)/ -10000S (no power cord)
- APS600W-200NES (NA, UK, EU)/ -200AJS (JP, AU)/ -20000S (no power cord)
- APS920W-100NES (NA, UK, EU)/ -100AJS (JP, AU)/ -10000S (no power cord)
- APS2000W-100NES (NA, UK, EU)/ -100AJS (JP, AU)/ -10000S (no power cord)

- 48 Gigabit PoE+ ports with 4 10GBASE-X SFP+ uplinks.
- 550W internal power supply providing 236W of PoE budget.
- 2 slots for modular power supplies (1+1 redundancy and/or EPS share).
- Any APS350W, APS600Wv2, APS920W, or APS2000W can be used.
- The PoE budget can reach 1,440W, the redundant PoE budget can also reach 1,440W.
- Virtual Chassis stacking provides non-stop forwarding (NSF) and hitless failover.
- Layer 3 feature set includes static, policy-based, and dynamic routing.
- NETGEAR IT Web User Interface, speed up Campus IT installations.
- NETGEAR ProSAFE® Limited Lifetime Hardware Warranty.
- Lifetime Next Business Day Hardware Replacement.
- Dimensions: 440*400*43.2 mm
- Weight: 7.19Kg (15.85 lb)

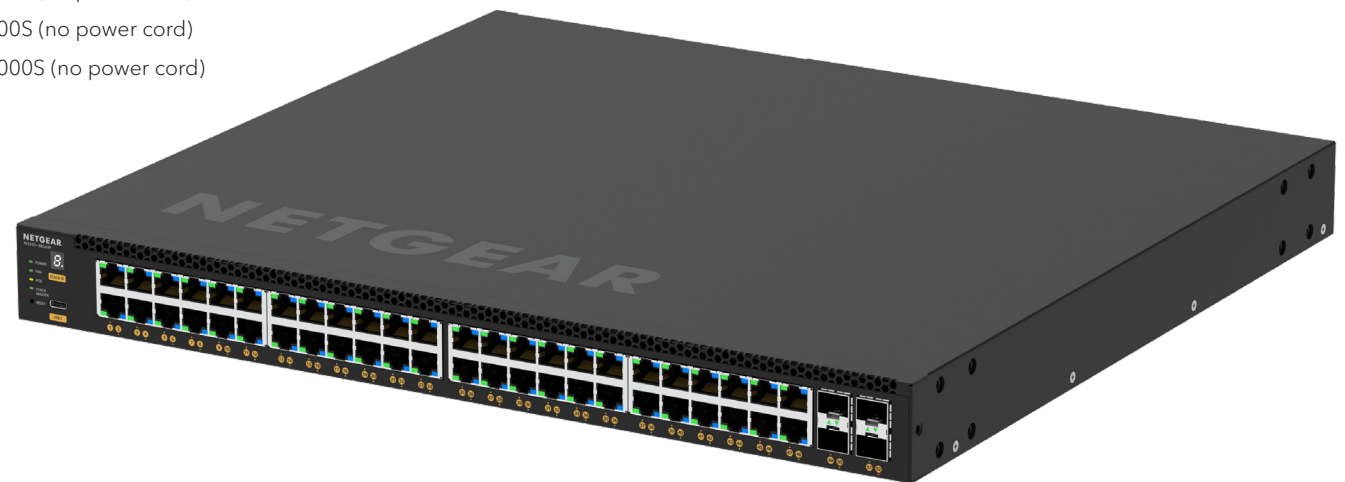

Components

M4350-8M2V Fully Managed Switch

Ordering information

- Americas, Europe: MSM4310-100NES (NA, UK, EU)
- Americas, TAA Compliant: MSM4310-TAANES (NA, UK, EU)
- Asia Pacific: MSM4310-100AJS (JP, AU)
- China: MSM4310-100PRS
- Warranty: Lifetime ProSAFE Hardware Warranty



PSU and Tray Ordering information

- APS254W-10000S (no AC power cord)
- PST4310-10000S (Half-Width PSU Tray)

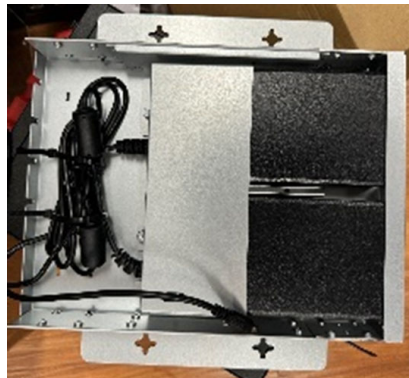

PSUTray	PSUTray
MSM4310	MSM4310
MSM4310	PSUTray
MSM4310	PSUTray
PSUTray	MSM4310
MSM4310	PSUTray

- 8 2.5G PoE++ ports with 2 25GBASE-X SFP28 uplinks.
- 10 Gigabit only, or 25 Gigabit only supported on SFP28 ports 9-10.
- Individual RGB LED under each port, representing the color of the AV profile in AVUI and Engage.
- Comes with one APS254W power adapter providing 119W of base PoE budget.
- 3 DC connectors for up to 3 APS254W power adapters (2+1 redundancy and/or EPS share).
- The PoE budget can reach 551W, the redundant PoE budget can reach 119W (1+1) or 322W (2+1).
- Half-width form factor enables one or two switches in a single rack space.
- The PST4310 half-width PSU tray can support 2 x APS254W alongside the switch, or under/above
- The PST4310 tray can be assembled in 2x2 fashion with 2 MSM4310 and 2 PSU trays
- Virtual Chassis stacking provides non-stop forwarding (NSF) and hitless failover.
- Layer 3 feature set includes static, policy-based, and dynamic routing.
- NETGEAR IT Web User Interface, speed up Campus IT installations.
- NETGEAR ProSAFE® Limited Lifetime Hardware Warranty.
- Lifetime Next Business Day Hardware Replacement.
- Dimensions: 220*300*43.2 mm
- Weight: 2.9Kg (6.39 lb)



Components

M4350-24M4X4V Fully Managed Switch

Ordering information

- Americas, Europe: MSM4332-100NES (NA, UK, EU)
- Americas, TAA Compliant: MSM4332-TAANES (NA, UK, EU)
- Asia Pacific: MSM4332-100AJS (JP, AU)
- China: MSM4332-100PRS
- Warranty: Lifetime ProSAFE Hardware Warranty



PSU Ordering information

- APS600W-300NES (NA, UK, EU)/ -300AJS (JP, AU)/ -30000S (no power cord)
- APS1200W-200NES (NA, UK, EU)/ -200AJS (JP, AU)/ -20000S (no power cord)
- APS2000W-200NES (NA, UK, EU)/ -200AJS (JP, AU)/ -20000S (no power cord)

- 24 2.5G and 4 10G/Multi-gig PoE++ ports with 4 25GBASE-X SFP28 uplinks.
- 10 Gigabit only, or 25 Gigabit only supported on SFP28 ports 29-32.
- Individual RGB LED under each port, representing the color of the AV profile in AVUI and Engage.
- 800W internal power supply providing 522W of PoE budget.
- 2 slots for modular power supplies (1+1 redundancy and/or EPS share).
- Any APS600Wv3, APS1200Wv2, or APS2000Wv2 can be used.
- The PoE budget can reach 2,520W, the redundant PoE budget can reach 1,972W.
- Virtual Chassis stacking provides non-stop forwarding (NSF) and hitless failover.
- Layer 3 feature set includes static, policy-based, and dynamic routing.
- NETGEAR IT Web User Interface, speed up Campus IT installations.
- NETGEAR ProSAFE® Limited Lifetime Hardware Warranty.
- Lifetime Next Business Day Hardware Replacement.
- Dimensions: 440*400*43.2 mm
- Weight: 7.38Kg (16.26 lb)



Components

M4350-44M4X4V

Fully Managed Switch

Ordering information

- Americas, Europe: MSM4352-100NES (NA, UK, EU)
- Americas, TAA Compliant: MSM4352-TAANES (NA, UK, EU)
- Asia Pacific: MSM4352-100AJS (JP, AU)
- China: MSM4352-100PRS
- Warranty: Lifetime ProSAFE Hardware Warranty



PSU Ordering information

- APS350W-100NES (NA, UK, EU)/ -100AJS (JP, AU)/ -10000S (no power cord)
- APS600W-200NES (NA, UK, EU)/ -200AJS (JP, AU)/ -20000S (no power cord)
- APS920W-100NES (NA, UK, EU)/ -100AJS (JP, AU)/ -10000S (no power cord)
- APS2000W-100NES (NA, UK, EU)/ -100AJS (JP, AU)/ -10000S (no power cord)

- 44 2.5G and 4 10G/Multi-gig PoE++ ports with 4 25GBASE-X SFP28 uplinks.
- Fast Ethernet (100Mbps) only supported on 2.5G ports 1-44.
- 10 Gigabit only, or 25 Gigabit only supported on SFP28 ports 49-52.
- 550W internal power supply providing 194W of PoE budget
- 2 slots for modular power supplies (1+1 redundancy and/or EPS share).
- Any APS350W, APS600Wv2, APS920W, or APS2000W can be used.
- The PoE budget can reach 3,314W, the redundant PoE budget can reach 1,794W.
- Virtual Chassis stacking provides non-stop forwarding (NSF) and hitless failover.
- Layer 3 feature set includes static, policy-based, and dynamic routing.
- NETGEAR IT Web User Interface, speed up Campus IT installations.
- NETGEAR ProSAFE® Limited Lifetime Hardware Warranty.
- Lifetime Next Business Day Hardware Replacement.
- Dimensions: 440x400x43.2 mm
- Weight: 7.34Kg (16.18 lb)



Components

M4350-24F4X

Fully Managed Switch

Ordering information

- Americas, Europe: MSM4328F-100NES (NA, UK, EU)
- Americas, TAA Compliant: MSM4328F-TAANES (NA, UK, EU)
- Asia Pacific: MSM4328F-100AJS (JP, AU)
- China: MSM4328F-100PRS
- Warranty: Lifetime ProSAFE Hardware Warranty



PSU Ordering information

- APS600W-300NES (NA, UK, EU)/ -300AJS (JP, AU)/ -30000S (no power cord)
- APS1200W-200NES (NA, UK, EU)/ -200AJS (JP, AU)/ -20000S (no power cord)
- APS2000W-200NES (NA, UK, EU)/ -200AJS (JP, AU)/ -20000S (no power cord)

- 24 1G/2.5GBASE-X SFP ports with 4 combo 10GBASE-T / 10GBASE-X SFP+ uplinks.
- 100M, 1G, 2.5G, 5G or 10 Gigabit supported on 10GBASE-T ports 25-28.
- 1 Gigabit or 10 Gigabit only supported on 10GBASE-X SFP+ ports 25F-28F.
- Individual RGB LED under each port, representing the color of the AV profile in AVUI and Engage.
- 240W internal power supply.
- 1 slot for modular power supply (1+1 redundancy).
- Any APS600Wv3, APS1200Wv2, or APS2000Wv2 can be used.
- Virtual Chassis stacking provides non-stop forwarding (NSF) and hitless failover.
- Layer 3 feature set includes static, policy-based, and dynamic routing.
- NETGEAR IT Web User Interface, speed up Campus IT installations.
- NETGEAR ProSAFE® Limited Lifetime Hardware Warranty.
- Lifetime Next Business Day Hardware Replacement.
- Dimensions: 440*400*43.2 mm
- Weight: 7.38Kg (16.26 lb)



Components

M4350-8X8F

Fully Managed Switch

Ordering information

- Americas, Europe: XSM4316-100NES (NA, UK, EU)
- Asia Pacific: XSM4316-100AJS (JP, AU)
- China: XSM4316-100PRS
- Warranty: Lifetime ProSAFE Hardware Warranty

- 8 10G/Multi-Gig ports, and 8 10GBASE-X SFP+ ports.
- Gigabit (1000Mbps) only supported on Copper ports 1-8 and SFP+ ports 9-12.
- 240W internal power supply.
- Half-width form factor enables one or two switches in a single rack space for redundant top-of-rack.
- Virtual Chassis stacking provides non-stop forwarding (NSF) and hitless failover.
- Layer 3 feature set includes static, policy-based, and dynamic routing.
- NETGEAR IT Web User Interface, speed up Campus IT installations.
- NETGEAR ProSAFE® Limited Lifetime Hardware Warranty.
- Lifetime Next Business Day Hardware Replacement.
- Dimensions: 220x400x43.2 mm
- Weight: 4.05Kg (8.93 lb)

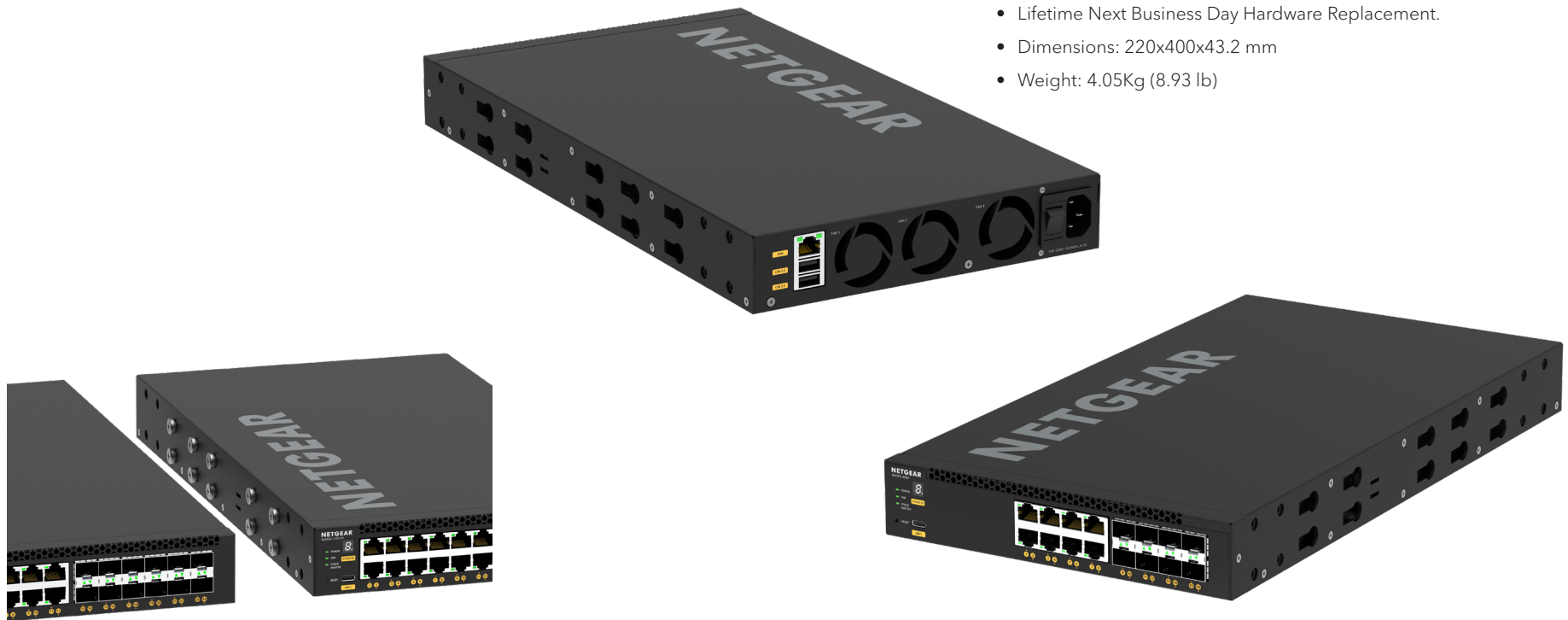

Components

M4350-12X12F

Fully Managed Switch

Ordering information

- Americas, Europe: XSM4324-100NES (NA, UK, EU)
- Asia Pacific: XSM4324-100AJS (JP, AU)
- China: XSM4324-100PRS
- Warranty: Lifetime ProSAFE Hardware Warranty

- 12 10G/Multi-Gig ports, and 12 10GBASE-X SFP+ ports.
- Gigabit (1000Mbps) only supported on Copper ports 1-12 and SFP+ ports 13-20.
- 240W internal power supply.
- Half-width form factor enables one or two switches in a single rack space for redundant top-of-rack.
- Virtual Chassis stacking provides non-stop forwarding (NSF) and hitless failover.
- Layer 3 feature set includes static, policy-based, and dynamic routing.
- NETGEAR IT Web User Interface, speed up Campus IT installations.
- NETGEAR ProSAFE® Limited Lifetime Hardware Warranty.
- Lifetime Next Business Day Hardware Replacement.
- Dimensions: 220x400x43.2 mm
- Weight: 4.3Kg (9.48 lb)

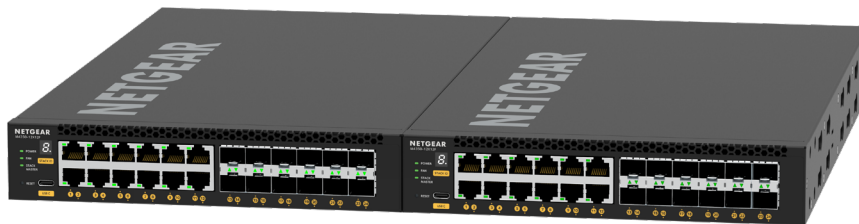

Components

M4350-24X4V

Fully Managed Switch

Ordering information

- Americas, Europe: XSM4328CV-100NES (NA, UK, EU)
- Americas, TAA Compliant: XSM4328CV-TAANES (NA, UK, EU)
- Asia Pacific: XSM4328CV-100AJS (JP, AU)
- China: XSM4328CV-100PRS
- Warranty: Lifetime ProSAFE Hardware Warranty



PSU Ordering information

- APS350W-100NES (NA, UK, EU)/ -100AJS (JP, AU)/ -10000S (no power cord)
- APS600W-200NES (NA, UK, EU)/ -200AJS (JP, AU)/ -20000S (no power cord)
- APS920W-100NES (NA, UK, EU)/ -100AJS (JP, AU)/ -10000S (no power cord)
- APS2000W-100NES (NA, UK, EU)/ -100AJS (JP, AU)/ -10000S (no power cord)

- 24 10G/Multi-Gig PoE+ ports with 4 25GBASE-X SFP28 uplinks.
- Fast Ethernet (100Mbps) only supported on Copper ports 1-16.
- 10 Gigabit only, or 25 Gigabit only supported on SFP28 ports 25-28.
- 880W internal power supply providing 576W of PoE budget.
- 1 slot for modular power supply (1+1 redundancy and/or EPS share).
- Any APS350W, APS600Wv2, APS920W, or APS2000W can be used.
- The PoE budget can reach 720W, when the redundant PoE budget remains 576W.
- Virtual Chassis stacking provides non-stop forwarding (NSF) and hitless failover.
- Layer 3 feature set includes static, policy-based, and dynamic routing.
- NETGEAR IT Web User Interface, speed up Campus IT installations.
- NETGEAR ProSAFE® Limited Lifetime Hardware Warranty.
- Lifetime Next Business Day Hardware Replacement.
- Dimensions: 440x400x43.2 mm
- Weight: 6.58Kg (14.51 lb)



Components

M4350-24F4V

Fully Managed Switch

Ordering information

- Americas, Europe: XSM4328FV-100NES (NA, UK, EU)
- Asia Pacific: XSM4328FV-100AJS (JP, AU)
- China: XSM4328FV-100PRS
- Warranty: Lifetime ProSAFE Hardware Warranty



PSU Ordering information

- APS350W-100NES (NA, UK, EU)/ -100AJS (JP, AU)/ -10000S (no power cord)
- APS600W-200NES (NA, UK, EU)/ -200AJS (JP, AU)/ -20000S (no power cord)
- APS920W-100NES (NA, UK, EU)/ -100AJS (JP, AU)/ -10000S (no power cord)
- APS2000W-100NES (NA, UK, EU)/ -100AJS (JP, AU)/ -10000S (no power cord)

- 24 10GBASE-X SFP+ ports with 4 25GBASE-X SFP28 uplinks.
- Gigabit (1000Mbps) only supported on SFP+ ports 1-16.
- 10 Gigabit only, or 25 Gigabit only supported on SFP28 ports 25-28.
- 240W internal power supply.
- 1 slot for modular power supply (1+1 redundancy).
- Any APS350W, APS600Wv2, APS920W, or APS2000W can be used.
- Virtual Chassis stacking provides non-stop forwarding (NSF) and hitless failover.
- Layer 3 feature set includes static, policy-based, and dynamic routing.
- NETGEAR IT Web User Interface, speed up Campus IT installations.
- NETGEAR ProSAFE® Limited Lifetime Hardware Warranty.
- Lifetime Next Business Day Hardware Replacement.
- Dimensions: 440x400x43.2 mm
- Weight: 6.25Kg (13.78 lb)



Components

M4350-36X4V

Fully Managed Switch

Ordering information

- Americas, Europe: XSM4340CV-100NES (NA, UK, EU)
- Asia Pacific: XSM4340CV-100AJS (JP, AU)
- China: XSM4340CV-100PRS
- Warranty: Lifetime ProSAFE Hardware Warranty



PSU Ordering information

- APS600W-300NES (NA, UK, EU)/ -300AJS (JP, AU)/ -30000S (no power cord)
- APS1200W-200NES (NA, UK, EU)/ -200AJS (JP, AU)/ -20000S (no power cord)
- APS2000W-200NES (NA, UK, EU)/ -200AJS (JP, AU)/ -20000S (no power cord)

- 36 10G/Multi-Gig PoE++ ports with 4 25GBASE-X SFP28 uplinks.
- Fast Ethernet (100Mbps) only supported on ports 1-28.
- 10 Gigabit only, or 25 Gigabit only supported on SFP28 ports 25-28.
- 750W internal power supply providing 280W of PoE budget.
- 1 slot for modular power supply (1+1 redundancy and/or EPS share).
- Any APS600Wv3, APS1200Wv2, or APS2000Wv2 can be used.
- The PoE budget can reach 1,760W, when the redundant PoE budget remains 280W.
- Virtual Chassis stacking provides non-stop forwarding (NSF) and hitless failover.
- Layer 3 feature set includes static, policy-based, and dynamic routing.
- NETGEAR IT Web User Interface, speed up Campus IT installations.
- NETGEAR ProSAFE® Limited Lifetime Hardware Warranty.
- Lifetime Next Business Day Hardware Replacement.
- Dimensions: 440x400x43.2 mm
- Weight: 7.33Kg (16.16 lb)



Components

M4350-24X8F8V

Fully Managed Switch

Ordering information

- Americas, Europe: XSM4340V-100NES (NA, UK, EU)
- Americas, TAA Compliant: XSM4340V-TAANES (NA, UK, EU)
- Asia Pacific: XSM4340V-100AJS (JP, AU)
- China: XSM4340V-100PRS
- Warranty: Lifetime ProSAFE Hardware Warranty



PSU Ordering information

- APS600W-300NES (NA, UK, EU)/ -300AJS (JP, AU)/ -30000S (no power cord)
- APS1200W-200NES (NA, UK, EU)/ -200AJS (JP, AU)/ -20000S (no power cord)
- APS2000W-200NES (NA, UK, EU)/ -200AJS (JP, AU)/ -20000S (no power cord)

- 24 10G/Multi-Gig PoE++ ports, 8 10GBASE-X SFP+ and 8 25GBASE-X SFP28 ports.
- Fast Ethernet (100Mbps) is supported on Copper ports 1-24.
- Gigabit (1000Mbps) only supported on SFP+ ports 25-28
- 10 Gigabit only, or 25 Gigabit only on SFP28 ports 33-40, per 4-port block.
- 750W internal power supply providing 290W of PoE budget.
- 1 slot for modular power supply (1+1 redundancy and/or EPS share).
- Any APS600Wv3, APS1200Wv2, or APS2000Wv2 can be used.
- The PoE budget can reach 1,770W, when the redundant PoE budget remains 290W.
- Virtual Chassis stacking provides non-stop forwarding (NSF) and hitless failover.
- Layer 3 feature set includes static, policy-based, and dynamic routing.
- NETGEAR IT Web User Interface, speed up Campus IT installations.
- NETGEAR ProSAFE® Limited Lifetime Hardware Warranty.
- Lifetime Next Business Day Hardware Replacement.
- Dimensions: 440x400x43.2 mm
- Weight: 7.24Kg (15.96 lb)



Components

M4350-32F8V

Fully Managed Switch

Ordering information

- Americas, Europe: XSM4340FV-100NES (NA, UK, EU)
- Americas, TAA Compliant: XSM4340FV-TAANES (NA, UK, EU)
- Asia Pacific: XSM4340FV-100AJS (JP, AU)
- China: XSM4340FV-100PRS
- Warranty: Lifetime ProSAFE Hardware Warranty



PSU Ordering information

- APS600W-300NES (NA, UK, EU)/ -300AJS (JP, AU)/ -30000S (no power cord)
- APS1200W-200NES (NA, UK, EU)/ -200AJS (JP, AU)/ -20000S (no power cord)
- APS2000W-200NES (NA, UK, EU)/ -200AJS (JP, AU)/ -20000S (no power cord)

- 32 10GBASE-X SFP+ ports with 8 25GBASE-X SFP28 uplinks.
- Gigabit (1000Mbps) only supported on SFP+ ports 1-28.
- 10 Gigabit only, or 25 Gigabit only on SFP28 ports 33-40, per 4-port block
- 420W internal power supply
- 1 slot for modular power supply (1+1 redundancy).
- Any APS600Wv3, APS1200Wv2, or APS2000Wv2 can be used.
- Virtual Chassis stacking provides non-stop forwarding (NSF) and hitless failover.
- Layer 3 feature set includes static, policy-based, and dynamic routing.
- NETGEAR IT Web User Interface, speed up Campus IT installations.
- NETGEAR ProSAFE® Limited Lifetime Hardware Warranty.
- Lifetime Next Business Day Hardware Replacement.
- Dimensions: 440x400x43.2 mm
- Weight: 6.95Kg (15.32 lb)



Components

M4350-16V4C

Fully Managed Switch

Ordering information

- Americas, Europe: VSM4320C-100NES (NA, UK, EU)
- Americas, TAA Compliant: VSM4320C-TAANES (NA, UK, EU)
- Asia Pacific: VSM4320C-100AJS (JP, AU)
- China: VSM4320C-100PRS
- Warranty: Lifetime ProSAFE Hardware Warranty



PSU Ordering information

- APS600W-300NES (NA, UK, EU)/ -300AJS (JP, AU)/ -30000S (no power cord)
- APS1200W-200NES (NA, UK, EU)/ -200AJS (JP, AU)/ -20000S (no power cord)
- APS2000W-200NES (NA, UK, EU)/ -200AJS (JP, AU)/ -20000S (no power cord)

- 16 25GBASE-X SFP28 ports with 4 100GBASE-X QSFP28 uplinks.
- 10 Gigabit only, or 25 Gigabit only on SFP28 ports 1-16, per 4-port block.
- 420W internal power supply
- 1 slot for modular power supply (1+1 redundancy).
- Any APS600Wv3, APS1200Wv2, or APS2000Wv2 can be used.
- Virtual Chassis stacking provides non-stop forwarding (NSF) and hitless failover.
- Layer 3 feature set includes static, policy-based, and dynamic routing.
- NETGEAR IT Web User Interface, speed up Campus IT installations.
- NETGEAR ProSAFE® Limited Lifetime Hardware Warranty.
- Lifetime Next Business Day Hardware Replacement.
- Dimensions: 440x400x43.2 mm
- Weight: 7.15Kg (15.77 lb)

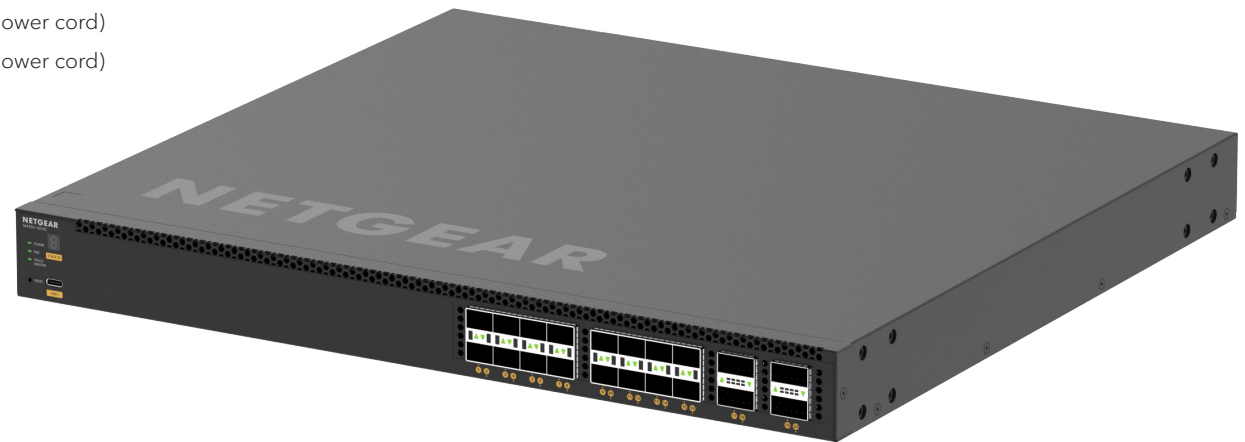

Components

M4350-40X4C

Fully Managed Switch

Ordering information

- Americas, Europe: XSM4344C-100NES (NA, UK, EU)
- Americas, TAA Compliant: XSM4344C-TAANES (NA, UK, EU)
- Asia Pacific: XSM4344C-100AJS (JP, AU)
- China: XSM4344C-100PRS
- Warranty: Lifetime ProSAFE Hardware Warranty



PSU Ordering information

- APS600W-300NES (NA, UK, EU)/ -300AJS (JP, AU)/ -30000S (no power cord)
- APS1200W-200NES (NA, UK, EU)/ -200AJS (JP, AU)/ -20000S (no power cord)
- APS2000W-200NES (NA, UK, EU)/ -200AJS (JP, AU)/ -20000S (no power cord)

- 40 10G/Multi-Gig PoE++ ports with 4 100GBASE-X QSFP28 uplinks.
- Fast Ethernet (100Mbps) is not supported, on any port.
- 750W internal power supply providing 196W of PoE budget.
- 1 slot for modular power supply (1+1 redundancy and/or EPS share).
- Any APS600Wv3, APS1200Wv2, or APS2000Wv2 can be used.
- The PoE budget can reach 1,676W, when the redundant PoE budget remains 196W.
- Virtual Chassis stacking provides non-stop forwarding (NSF) and hitless failover.
- Layer 3 feature set includes static, policy-based, and dynamic routing.
- NETGEAR IT Web User Interface, speed up Campus IT installations.
- NETGEAR ProSAFE® Limited Lifetime Hardware Warranty.
- Lifetime Next Business Day Hardware Replacement.
- Dimensions: 440x400x43.2 mm
- Weight: 7.76Kg (17.11 lb)



Components

M4350-40F4C

Fully Managed Switch

Ordering information

- Americas, Europe: XSM4344FC-100NES (NA, UK, EU)
- Americas, TAA Compliant: XSM4344FC-TAANES (NA, UK, EU)
- Asia Pacific: XSM4344FC-100AJS (JP, AU)
- China: XSM4344FC-100PRS
- Warranty: Lifetime ProSAFE Hardware Warranty



PSU Ordering information

- APS600W-300NES (NA, UK, EU)/ -300AJS (JP, AU)/ -30000S (no power cord)
- APS1200W-200NES (NA, UK, EU)/ -200AJS (JP, AU)/ -20000S (no power cord)
- APS2000W-200NES (NA, UK, EU)/ -200AJS (JP, AU)/ -20000S (no power cord)

- 40 10GBASE-X SFP+ ports with 4 100GBASE-X QSFP28 uplinks.
- 1 Gigabit or 10 Gigabit only supported on 10GBASE-X SFP+ ports 1-40.
- Individual RGB LED under each port, representing the color of the AV profile in AVUI and Engage.
- 420W internal power supply.
- 1 slot for modular power supply (1+1 redundancy).
- Any APS600Wv3, APS1200Wv2, or APS2000Wv2 can be used.
- Virtual Chassis stacking provides non-stop forwarding (NSF) and hitless failover.
- Layer 3 feature set includes static, policy-based, and dynamic routing.
- NETGEAR IT Web User Interface, speed up Campus IT installations.
- NETGEAR ProSAFE® Limited Lifetime Hardware Warranty.
- Lifetime Next Business Day Hardware Replacement.
- Dimensions: 440x400x43.2 mm
- Weight: 7.38Kg (16.26 lb)



Components

APS254W

External Power Adapter

Ordering information

- Worldwide: APS254W-10000S (no power cord)
- Warranty: 2 years



- External power adapter for M4350-8M2V (MSM4310), and M4250-8G2XF-PoE+ (GSM4210PX).
- C14 connector.
- For use with a local AC power cord (not included)
- 110V-240V AC power input.
- Up to 254W output power at 110/220V AC.
- Width: 3.5 inches (88.9 mm) - Height: 1.54 inches (39 mm) - Depth: 7.76 inches (197mm)
- 2-Year Warranty

APS350W

Power Supply Unit

Ordering information

- Americas, Europe: APS350W-100NES (NA, UK, EU)
- Asia Pacific: APS350W-100AJS (JP, AU)
- Asia Pacific: APS350W-10000S (no power cord)
- Warranty: 5 years



- PSU for M4350-24G4XF (GSM4328), M4350-48G4XF (GSM4352), M4350-44M4X4V (MSM4352), M4350-24X4V (XSM4328CV), and M4350-24F4V (XSM4328FV).
- C14 connector.
- 110V-240V AC power input.
- Up to 350W output power at 110/220V AC.
- 5-Year Warranty

Components

APS600Wv2

Power Supply Unit

Ordering information

- Americas, Europe: APS600W-200NES (NA, UK, EU)
- Asia Pacific: APS600W-200AJS (JP, AU)
- Asia Pacific: APS600W-20000S (no power cord)
- Warranty: 5 years



- PSU for M4350-24M4X4V (MSM4332), M4350-24F4X (MSM4328F), M4350-36X4V (XSM4340CV), M4350-24X8F8V (XSM4340V), M4350-32F8V (XSM4340FV), M4350-16V4C (VSM4320C), M4350-40X4C (XSM4344C), and M4350-40F4C (XSM4344FC).
- C14 connector.
- 110V-240V AC power input.
- Up to 600W output power at 110/220V AC.
- 5-Year Warranty

APS600Wv3

Power Supply Unit

Ordering information

- Americas, Europe: APS600W-300NES (NA, UK, EU)
- Asia Pacific: APS600W-300AJS (JP, AU)
- Asia Pacific: APS600W-30000S (no power cord)
- Warranty: 5 years

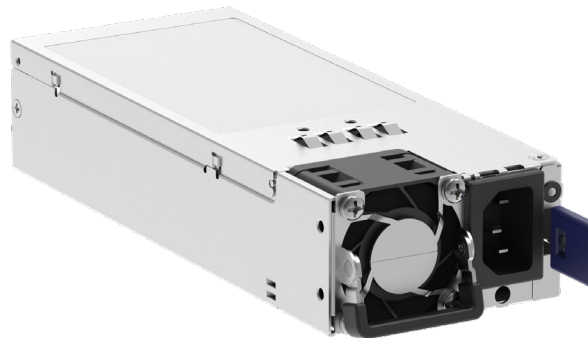

- PSU for M4350-24M4X4V (MSM4332), M4350-24F4X (MSM4328F), M4350-36X4V (XSM4340CV), M4350-24X8F8V (XSM4340V), M4350-32F8V (XSM4340FV), M4350-16V4C (VSM4320C), M4350-40X4C (XSM4344C), and M4350-40F4C (XSM4344FC).
- C14 connector.
- 110V-240V AC power input.
- Up to 600W output power at 110/220V AC.
- 5-Year Warranty

Components

APS920W

Power Supply Unit

Ordering information

- Americas, Europe: APS920W-100NES (NA, UK, EU)
- Asia Pacific: APS920W-100AJS (JP, AU)
- Asia Pacific: APS920W-10000S (no power cord)
- Warranty: 5 years



- PSU for M4350-24G4XF (GSM4328), M4350-48G4XF (GSM4352), M4350-44M4X4V (MSM4352), M4350-24X4V (XSM4328CV), and M4350-24F4V (XSM4328FV).
- C14 connector.
- 110V-240V AC power input.
- Up to 920W output power at 110/220V AC.
- 5-Year Warranty

APS1200Wv2

Power Supply Unit

Ordering information

- Americas, Europe: APS1200W-200NES (NA, UK, EU)
- Asia Pacific: APS1200W-200AJS (JP, AU)
- Asia Pacific: APS1200W-20000S (no power cord)
- Warranty: 5 years



- PSU for M4350-24M4X4V (MSM4332), M4350-24F4X (MSM4328F), M4350-36X4V (XSM4340CV), M4350-24X8F8V (XSM4340V), M4350-32F8V (XSM4340FV), M4350-16V4C (VSM4320C), M4350-40X4C (XSM4344C), and M4350-40F4C (XSM4344FC).
- C14 connector.
- 110V-240V AC power input.
- Up to 1,200W output power at 110/220V AC.
- 5-Year Warranty

Components

APS2000W

Power Supply Unit

Ordering information

- Americas, Europe: APS2000W-100NES (NA, UK, EU)
- Asia Pacific: APS2000W-100AJS (JP, AU)
- Asia Pacific: APS2000W-10000S (no power cord)
- Warranty: 5 years



- PSU for M4350-24G4XF (GSM4328), M4350-48G4XF (GSM4352), M4350-44M4X4V (MSM4352), M4350-24X4V (XSM4328CV), and M4350-24F4V (XSM4328FV).
- C14 connector.
- 110V-240V AC power input.
- Up to 1,000W output power at 110V AC.
- Up to 2,000W output power at 220V AC.
- 5-Year Warranty

APS2000Wv2

Power Supply Unit

Ordering information



- Americas, Europe: APS2000W-200NES (NA, UK, EU)
- Asia Pacific: APS2000W-200AJS (JP, AU)
- Asia Pacific: APS2000W-20000S (no power cord)
- Warranty: 5 years



- PSU for M4350-24M4X4V (MSM4332), M4350-24F4X (MSM4328F), M4350-36X4V (XSM4340CV), M4350-24X8F8V (XSM4340V), M4350-32F8V (XSM4340FV), M4350-16V4C (VSM4320C), M4350-40X4C (XSM4344C), and M4350-40F4C (XSM4344FC).
- C14 connector.
- 110V-240V AC power input.
- Up to 1,000W output power at 110V AC.
- Up to 2,000W output power at 220V AC.
- 5-Year Warranty

Accessories

GBIC SFP and SFP+ Optics for M4350 series

Ordering information <ul style="list-style-type: none"> Worldwide: see table below Warranty: 5 years 	Multimode Fiber (MMF)		Single mode Fiber (SMF)
	OM1 or OM2 62.5/125µm	OM3 or OM4 50/125µm	9/125µm
10 Gigabit SFP+  <ul style="list-style-type: none"> Fits into M4350 SFP+ and SFP28* interfaces 	AXM763 10GBase-LRM long reach multimode 802.3aq - LC duplex connector up to 100m (328 ft) AXM763-10000S (1 unit)	AXM763 10GBase-LRM long reach multimode 802.3aq - LC duplex connector up to 165m (541 ft) AXM763-10000S (1 unit) AXM761 10GBase-SR short reach multimode LC duplex connector up to 300m (984 ft) AXM761-10000S (1 unit) AXM761P10-10000S (pack of 10 units)	AXM762 10GBase-LR long reach single mode LC duplex connector up to 10km (6.2 miles) AXM762-10000S (1 unit) AXM762P10-10000S (pack of 10 units) AXM764 10GBase-LR LITE single mode LC duplex connector up to 2km (1.2 mile) AXM764-10000S (1 unit)
Gigabit SFP  <ul style="list-style-type: none"> Fits into M4350 SFP+ and SFP28* interfaces 	AGM731F 1000Base-SX short range multimode LC duplex connector up to 275m (902 ft) AGM731F (1 unit)	AGM731F 1000Base-SX short range multimode LC duplex connector OM3: up to 550m (1,804 ft) OM4: up to 1,000m (3,280 ft) AGM731F (1 unit)	AGM732F 1000Base-LX long range single mode LC duplex connector up to 10km (6.2 miles) AGM732F (1 unit)

* ETHERNET Mode: Each 4 x 25G block is connected to a 100G SERDES. As such, each 4-port block can only work at the same speed: 4x1G, or 4x10G, or 4x25G. Since 25G takes precedence, when one 25G module is inserted, other ports with 1G or 10G modules get down in the same 4-port block.

STACKING Mode: Stacking link only works on the highest speed supported by a Stack port. A 25G port, when configured in Stack mode, only operates at 25G. It cannot operate at 10G. Similarly, a 100G port, when configured in Stack mode, only operates at 100G.

AGM734 1000BASE-T RJ45 SFP (Gigabit)	Ordering information <ul style="list-style-type: none"> Worldwide: AGM734-10000S Warranty: 5 years 		<ul style="list-style-type: none"> Fits into M4350 SFP+ and SFP28* interfaces 1 port Gigabit RJ45 Supports only 1000Mbps full-duplex mode Up to 100m (328 ft) with Cat5 RJ45 or better Conveniently adds 1G copper connectivity to M4350 fiber interfaces
AXM765 10GBASE-T RJ45 SFP+ (10 Gigabit)	Ordering information <ul style="list-style-type: none"> Worldwide: AXM765-20000S Warranty: 5 years 		<ul style="list-style-type: none"> Fits into M4350 SFP+ and SFP28* interfaces 1 port 10GBASE-T RJ45 Copper connectivity up to 80m (262 ft) distance CAT6a or better wiring required for 10GBASE-T up to 80 meters Conveniently adds 10G copper connectivity to M4350 fiber interfaces

Accessories

Direct Attach Cables for M4350 series

ORDERING INFORMATION WORLDWIDE: SEE TABLE BELOW WARRANTY: 5 YEARS	SFP+ to SFP+		
	1 meter (3.3 ft)	3 meters (9.8 ft)	5 meters (16.4 ft)
<p>10 Gigabit DAC</p>  <ul style="list-style-type: none"> • Fits into M4350 SFP+ and SFP28* interfaces 	<p>AXC761 10GSFP+ Cu (passive) SFP+ connectors</p> <p>AXC761-10000S (1 unit)</p>	<p>AXC763 10GSFP+ Cu (passive) SFP+ connectors</p> <p>AXC763-10000S (1 unit)</p>	<p>AXC765 10GSFP+ Cu (active) SFP+ connectors</p> <p>AXC765-10000S (1 unit)</p>
	7 meters (23.0 ft)	10 meters (32.8 ft)	15 meters (49.2 ft)
	<p>AXC767 10GSFP+ Cu (active) SFP+ connectors</p> <p>AXC767-10000S (1 unit)</p>	<p>AXC7610 10GSFP+ Cu (active) SFP+ connectors</p> <p>AXC7610-10000S (1 unit)</p>	<p>AXC7615 10GSFP+ (duplex fiber optic) SFP+ connectors</p> <p>AXC7615-10000S (1 unit)</p>
	20 meters (65.6 ft)		
	<p>AXC7620 10GSFP+ (duplex fiber optic) SFP+ connectors</p> <p>AXC7620-10000S (1 unit)</p>		

* ETHERNET Mode: Each 4 x 25G block is connected to a 100G SERDES. As such, each 4-port block can only work at the same speed: 4x1G, or 4x10G, or 4x25G. Since 25G takes precedence, when one 25G module is inserted, other ports with 1G or 10G modules get down in the same 4-port block.

STACKING Mode: Stacking link only works on the highest speed supported by a Stack port. A 25G port, when configured in Stack mode, only operates at 25G. It cannot operate at 10G. Similarly, a 100G port, when configured in Stack mode, only operates at 100G.

Ordering Information

NETGEAR M4350-24G4XF Fully Managed Switch (GSM4328) - 24x1G PoE+ and 4xSFP+ (648W base, up to 720W)		
North America; Europe		GSM4328-100NES (NA, UK, EU)
Asia Pacific		GSM4328-100AJS (JP, AU)
Asia Pacific		GSM4328-100PRS (CCC)
NETGEAR M4350-48G4XF Fully Managed Switch (GSM4352) - 48x1G PoE+ and 4xSFP+ (236W base, up to 1,440W)		
North America; Europe		GSM4352-100NES (NA, UK, EU)
Asia Pacific		GSM4352-100AJS (JP, AU)
Asia Pacific		GSM4352-100PRS (CCC)
NETGEAR M4350-8M2V Fully Managed Switch (MSM4310) - 8x2.5G PoE++ and 2xSFP28 25G (119W base, up to 551W)		
North America; Europe		MSM4310-100NES (NA, UK, EU)
North America; TAA Compliant		MSM4310-TAANES (NA, UK, EU)
Asia Pacific		MSM4310-100AJS (JP, AU)
Asia Pacific		MSM4310-100PRS (CCC)
NETGEAR M4350-24M4X4V Fully Managed Switch (MSM4332) - 24x2.5G, 4x10G/Multi-Gig PoE++ and 4xSFP28 25G (522W base, up to 2,520W)		
North America; Europe		MSM4332-100NES (NA, UK, EU)
North America; TAA Compliant		MSM4332-TAANES (NA, UK, EU)
Asia Pacific		MSM4332-100AJS (JP, AU)
Asia Pacific		MSM4332-100PRS (CCC)
NETGEAR M4350-44M4X4V Fully Managed Switch (MSM4352) - 44x2.5G, 4x10G/Multi-Gig PoE++ and 4xSFP28 25G (194W base, up to 3,314W)		
North America; Europe		MSM4352-100NES (NA, UK, EU)
North America; TAA Compliant		MSM4352-TAANES (NA, UK, EU)
Asia Pacific		MSM4352-100AJS (JP, AU)
Asia Pacific		MSM4352-100PRS (CCC)
NETGEAR M4350-24F4X 24xSFP and 4x10G Combo Copper / SFP+ - 24xSFP 1G/2.5G and 4x10G Combo Copper / SFP+		
North America; Europe		MSM4328F-100NES (NA, UK, EU)
North America; TAA Compliant		MSM4328F-TAANES (NA, UK, EU)
Asia Pacific		MSM4328F-100AJS (JP, AU)
Asia Pacific		MSM4328F-100PRS (CCC)



GSM4328



GSM4352



MSM4310



MSM4332



MSM4352



MSM4328F

Ordering Information

NETGEAR M4350-8X8F Fully Managed Switch (XSM4316) - 8x10G/Multi-Gig and 8xSFP+	
North America; Europe	XSM4316-100NES (NA, UK, EU)
Asia Pacific	XSM4316-100AJS (JP, AU)
Asia Pacific	XSM4316-100PRS (CCC)
NETGEAR M4350-12X12F Fully Managed Switch (XSM4324) - 12x10G/Multi-Gig and 12xSFP+	
North America; Europe	XSM4324-100NES (NA, UK, EU)
Asia Pacific	XSM4324-100AJS (JP, AU)
Asia Pacific	XSM4324-100PRS (CCC)
NETGEAR M4350-24X4V Fully Managed Switch (XSM4328CV) - 24x10G/Multi-Gig PoE+ and 4xSFP28 25G (576W base, up to 720W)	
North America; Europe	XSM4328CV-100NES (NA, UK, EU)
North America; TAA Compliant	XSM4328CV-TAANES (NA, UK, EU)
Asia Pacific	XSM4328CV-100AJS (JP, AU)
Asia Pacific	XSM4328CV-100PRS (CCC)
NETGEAR M4350-24F4V Fully Managed Switch (XSM4328FV) - 24xSFP+ and 4xSFP28 25G	
North America; Europe	XSM4328FV-100NES (NA, UK, EU)
Asia Pacific	XSM4328FV-100AJS (JP, AU)
Asia Pacific	XSM4328FV-100PRS (CCC)
NETGEAR M4350-36X4V Fully Managed Switch (XSM4340CV) - 36x10G/Multi-Gig PoE++ and 4xSFP28 25G (280W base, up to 1,760W)	
North America; Europe	XSM4340CV-100NES (NA, UK, EU)
Asia Pacific	XSM4340CV-100AJS (JP, AU)
Asia Pacific	XSM4340CV-100PRS (CCC)
NETGEAR M4350-24X8F8V Fully Managed Switch (XSM4340V) - 24x10G/Multi-Gig PoE++, 8xSFP+ and 8xSFP28 25G (290W base, up to 1,770W)	
North America; Europe	XSM4340V-100NES (NA, UK, EU)
North America; TAA Compliant	XSM4340V-TAANES (NA, UK, EU)
Asia Pacific	XSM4340V-100AJS (JP, AU)
Asia Pacific	XSM4340V-100PRS (CCC)



XSM4316



XSM4324



XSM4328CV



XSM4328FV



XSM4340CV



XSM4340V

Ordering Information

NETGEAR M4350-32F8V Fully Managed Switch (XSM4340FV) - 32xSFP+ and 8xSFP28 25G		
North America; Europe	XSM4340FV-100NES (NA, UK, EU)	
North America; TAA Compliant	XSM4340FV-TAANES (NA, UK, EU)	
Asia Pacific	XSM4340FV-100AJS (JP, AU)	
Asia Pacific	XSM4340FV-100PRS (CCC)	
NETGEAR M4350-16V4C Fully Managed Switch (VSM4320C) - 16xSFP28 25G and 4xQSFP28 100G		
North America; Europe	VSM4320C-100NES (NA, UK, EU)	
North America; TAA Compliant	VSM4320C-TAANES (NA, UK, EU)	
Asia Pacific	VSM4320C-100AJS (JP, AU)	
Asia Pacific	VSM4320C-100PRS (CCC)	
NETGEAR M4350-40X4C Fully Managed Switch (XSM4344C) - 40x10G/Multi-Gig PoE++ and 4xQSFP28 100G (196W base, up to 1,676W)		
North America; Europe	XSM4344C-100NES (NA, UK, EU)	
North America; TAA Compliant	XSM4344C-TAANES (NA, UK, EU)	
Asia Pacific	XSM4344C-100AJS (JP, AU)	
Asia Pacific	XSM4344C-100PRS (CCC)	
NETGEAR M4350-40F4C Fully Managed Switch (XSM4344FC) - 40xSFP+ and 4xQSFP28 100G		
North America; Europe	XSM4344FC-100NES (NA, UK, EU)	
North America; TAA Compliant	XSM4344FC-TAANES (NA, UK, EU)	
Asia Pacific	XSM4344FC-100AJS (JP, AU)	
Asia Pacific	XSM4344FC-100PRS (CCC)	
NETGEAR APS350W - 350W Power Supply Unit for M4350-24G4XF (GSM4328); M4350-48G4XF (GSM4352); M4350-44M4X4V (MSM4352); M4350-24X4V (XSM4328CV); M4350-24F4V (XSM4328FV)		
North America; Europe	APS350W-100NES (NA, UK, EU)	
Asia Pacific	APS350W-100AJS (JP, AU)	M4350-24G4XF (GSM4328)
Asia Pacific	APS350W-10000S (no power cords)	M4350-48G4XF (GSM4352)
		M4350-44M4X4V (MSM4352)
NETGEAR APS600Wv2 - 600W Power Supply Unit for M4350-24G4XF (GSM4328); M4350-48G4XF (GSM4352); M4350-44M4X4V (MSM4352); M4350-24X4V (XSM4328CV); M4350-24F4V (XSM4328FV)		
North America; Europe	APS600W-200NES (NA, UK, EU)	M4350-24X4V (XSM4328CV)
Asia Pacific	APS600W-200AJS (JP, AU)	M4350-24F4V (XSM4328FV)
Asia Pacific	APS600W-20000S (no power cords)	



XSM4340FV



VSM4320C



XSM4344C



XSM4344FC

Ordering Information

NETGEAR APS920W - 920W Power Supply Unit for M4350-24G4XF (GSM4328); M4350-48G4XF (GSM4352); M4350-44M4X4V (MSM4352); M4350-24X4V (XSM4328CV); M4350-24F4V (XSM4328FV)		
North America; Europe	APS920W-100NES (NA, UK, EU)	
Asia Pacific	APS920W-100AJS (JP, AU)	M4350-24G4XF (GSM4328)
Asia Pacific	APS920W-10000S (no power cords)	M4350-48G4XF (GSM4352)
		M4350-44M4X4V (MSM4352)
		M4350-24X4V (XSM4328CV)
		M4350-24F4V (XSM4328FV)
NETGEAR APS2000W - 2000W Power Supply Unit for M4350-24G4XF (GSM4328); M4350-48G4XF (GSM4352); M4350-44M4X4V (MSM4352); M4350-24X4V (XSM4328CV); M4350-24F4V (XSM4328FV)		
North America; Europe	APS2000W-100NES (NA, UK, EU)	
Asia Pacific	APS2000W-100AJS (JP, AU)	
Asia Pacific	APS2000W-10000S (no power cords)	
NETGEAR APS600Wv3 - 600W Power Supply Unit for M4350-24M4X4V (MSM4332), M4350-24F4X (MSM4328F), M4350-36X4V (XSM4340CV), M4350-24X8F8V (XSM4340V), M4350-32F8V (XSM4340FV), M4350-16V4C (VSM4320C), M4350-40X4C (XSM4344C), M4350-40F4C (XSM4344FC)		
North America; Europe	APS600W-300NES (NA, UK, EU)	
Asia Pacific	APS600W-300AJS (JP, AU)	
Asia Pacific	APS600W-30000S (no power cords)	M4350-24M4X4V (MSM4332)
		M4350-24F4X (MSM4328F)
		M4350-36X4V (XSM4340CV)
		M4350-24X8F8V (XSM4340V)
		M4350-32F8V (XSM4340FV)
		M4350-16V4C (VSM4320C)
		M4350-40X4C (XSM4344C)
		M4350-40F4C (XSM4344FC)
NETGEAR APS1200Wv2 - 1200W Power Supply Unit for M4350-24M4X4V (MSM4332), M4350-24F4X (MSM4328F), M4350-36X4V (XSM4340CV), M4350-24X8F8V (XSM4340V), M4350-32F8V (XSM4340FV), M4350-16V4C (VSM4320C), M4350-40X4C (XSM4344C), M4350-40F4C (XSM4344FC)		
North America; Europe	APS1200W-200NES (NA, UK, EU)	
Asia Pacific	APS1200W-200AJS (JP, AU)	
Asia Pacific	APS1200W-20000S (no power cords)	
NETGEAR APS2000Wv2 - 2000W Power Supply Unit for M4350-24M4X4V (MSM4332), M4350-24F4X (MSM4328F), M4350-36X4V (XSM4340CV), M4350-24X8F8V (XSM4340V), M4350-32F8V (XSM4340FV), M4350-16V4C (VSM4320C), M4350-40X4C (XSM4344C), M4350-40F4C (XSM4344FC)		
North America; Europe	APS2000W-200NES (NA, UK, EU)	
Asia Pacific	APS2000W-200AJS (JP, AU)	
Asia Pacific	APS2000W-20000S (no power cords)	
NETGEAR APS254W - 254W External Power Adapter for M4350-8M2V (MSM4310) and M4250-8G2XF-PoE+ (GSM4210PX)		
Worldwide	APS254W-10000S (no power cord)	
NETGEAR PST4310 - Half-width PSU Tray for M4350-8M2V (MSM4310)		
Worldwide	PST4310-10000S	

** This product comes with a limited warranty that is valid only if purchased from a NETGEAR authorized reseller, and covers unmodified hardware, fans and internal power supplies – not software or external power supplies, and requires product registration at <https://www.netgear.com/business/registration> within 90 days of purchase; see <https://www.netgear.com/about/warranty> for details. Intended for indoor use only.

NETGEAR, the NETGEAR Logo and ProSAFE are trademarks of NETGEAR, Inc. in the United States and/or other countries. Other brand names mentioned herein are for identification purposes only and may be trademarks of their respective holder(s). Information is subject to change without notice. © 2026 NETGEAR, Inc. All rights reserved.

NETGEAR, Inc., 1-888-NETGEAR (638-4327), E-mail: info@NETGEAR.com, www.NETGEAR.com

BR-M4350-Campus IT-6Apr26