

NETGEAR®

Installation Guide

4G LTE™ Router (LG2200D-1USNAS)

Package Contents

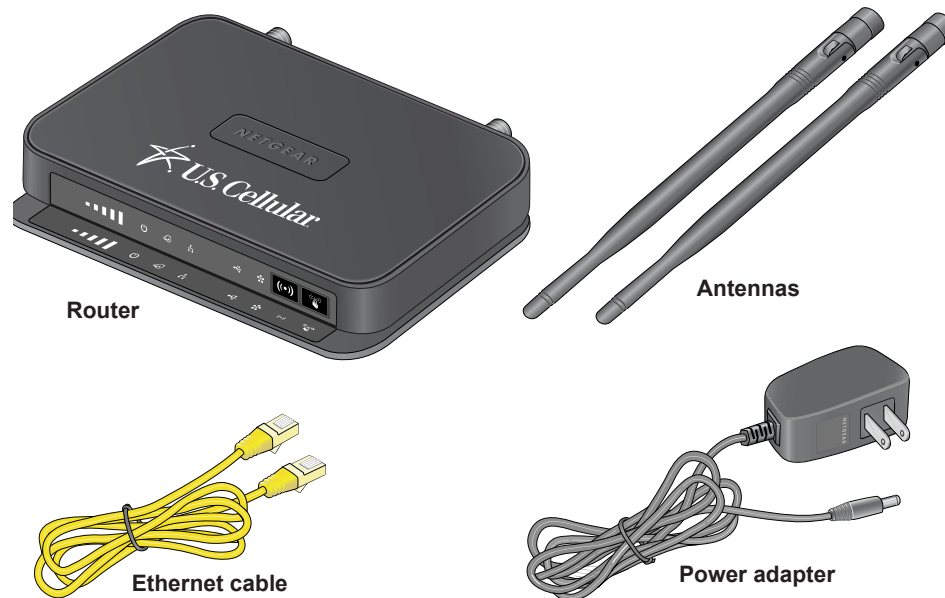

Note: This guide explains how to install the router with a mobile Internet connection. You can also use the Internet WAN port on the router to connect to a broadband cable or DSL modem.

Seat the SIM Card

Your router comes with a 3FF SIM (micro SIM) card already installed. If the SIM card is loose, you must seat it so that the router can detect it.

1. Unplug the router.
2. Open the SIM card compartment on the bottom of the router.

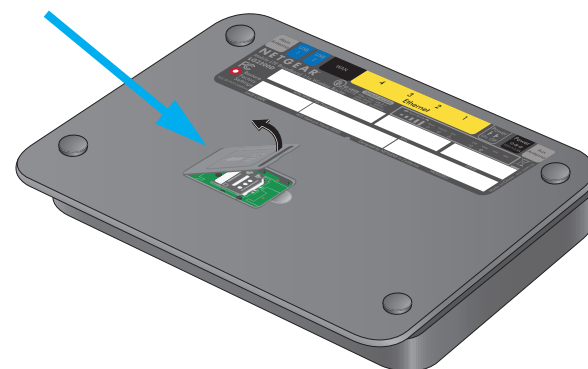

3. Press the edge of the SIM card holder to seat it in the router.

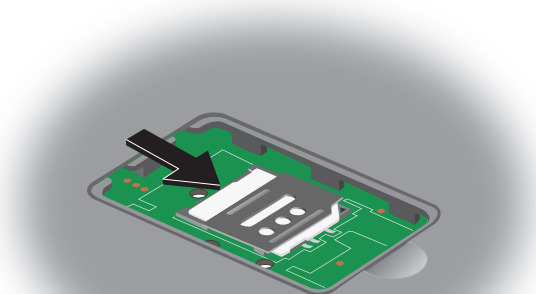

4. Close the SIM card compartment door.

Attach the Antennas

You must install both antennas for a 4G connection.

1. Align the antennas with the antenna posts on the router.
2. Attach the antennas on the threaded antenna posts, ensuring that the connection is secure.



3. Adjust the antenna positions. You can swivel the antennas in any direction.

Place the Router

Place the router in a location that receives a strong mobile signal (for example, near a window).

Do not put the router close to reflective or metal surfaces, such as mirrors, metal file cabinets, or stainless steel counter tops.

Do not put the router near electrical equipment or appliances such as microwave ovens that can generate WiFi signal interference.

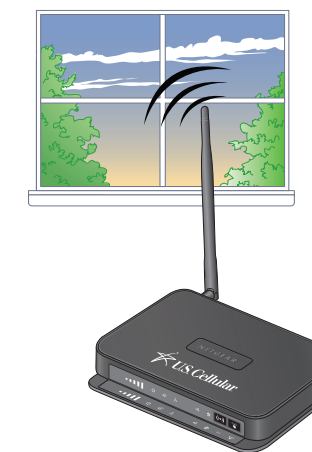

Install the Router

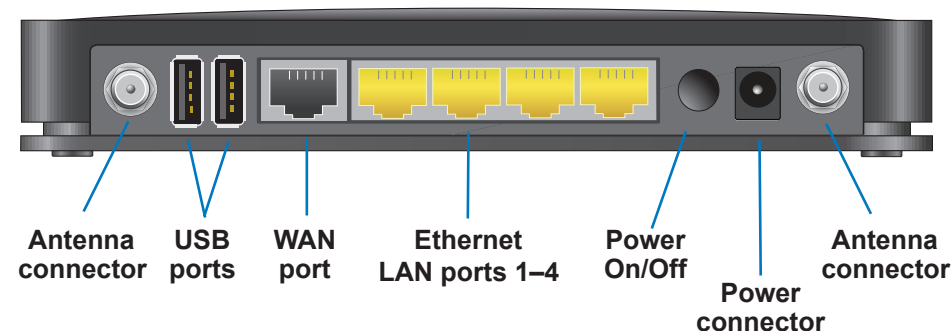

1. Connect the power adapter to the router and plug it into an electrical outlet.
2. If no LEDs light, press the **Power On/Off** button on the rear panel to power on the router.
3. Connect your router to a computer.

To connect from your wireless device using WiFi, use the WiFi network name and password on the router label.

For a wired connection, use an Ethernet cable to connect your computer to an unused yellow Ethernet LAN port on your router.

To connect wirelessly, press the **WPS** button  on the front of the router. Within two minutes, press the **WPS** button on your wireless device, or follow the WPS instructions that came with the device. For more information, refer to the user manual at <http://www.netgear.com>.

Note: If you purchased the router online, you might need to provide ICCID and MEID(DEC) values to activate the router. These values display on the product packaging.

Use a Web Browser to Access the Router

When you connect to the network, you can use a web browser such as Chrome, Firefox, or Internet Explorer to access the router to view or change its settings.

1. Launch a web browser from a computer or wireless device that is connected to the network.
2. Type **http://routerlogin.net** or **http://www.routerlogin.com** in the address field of the browser. A login screen displays.
3. Enter your user name and password. The default user name is **admin** and the default password is **password**. The BASIC Home screen displays. For more information, refer to the *4G LTE Router (LG2200D) User Manual* on <http://www.netgear.com>.
4. To verify the mobile Internet signal quality, check the Signal Quality LED . To improve signal quality, adjust the antennas or move the router.









When the router connects to the Internet, the Internet LED  lights white.

Once you have set up your router, you can use NETGEAR genie for tasks such as creating parental controls, changing your security settings, and monitoring your Internet usage.

Note: If the router cannot detect the SIM card, the message *No SIM Card Detected* displays and the NETGEAR genie Mobile Internet pane shows *Not Connected*. If you see this message, unplug the router and reseat the SIM card.

LEDs

The front panel of the router includes the following LEDs and buttons:

-  Signal Quality of the mobile broadband service
-  Power
-  Internet
-  Ethernet LAN ports 1–4
-  USB ports
-  WAN Internet port
-  WiFi On/Off button
-  WPS button

Troubleshooting

If the login screen does not display, try the following:

- Close and reopen the browser.
- Make sure that your computer is connected to one of the four yellow Ethernet LAN ports on the router, or that you are connected to your WiFi network.
- Make sure that the router has full power, and that its Power LED  is lit.
- If your computer is set to a static or fixed IP address, change it to obtain an IP address automatically from the router.

4G LTE not available in all areas. See your service provider for complete coverage details. LTE is a trademark of ETSI. NETGEAR, the NETGEAR logo, and NETGEAR genie are trademarks and/or registered trademarks of NETGEAR, Inc. and/or its subsidiaries in the United States and/or other countries. Other marks are the property of their respective owners. © 2014 NETGEAR, Inc. All rights reserved.

