



# NETGEAR<sup>®</sup>

---

## GS716T/GS724T

### Hardware Installation Guide

350 East Plumeria Drive  
San Jose, CA 95134  
USA

August 2012  
202-10510-03  
v2.0

## GS716T/GS724T Gigabit Smart Switch

© 2012 by NETGEAR, Inc. All rights reserved

No part of this publication may be reproduced, transmitted, transcribed, stored in a retrieval system, or translated into any language in any form or by any means without the written permission of NETGEAR, Inc.

NETGEAR, the NETGEAR logo, and Connect with Innovation are trademarks and/or registered trademarks of NETGEAR, Inc. and/or its subsidiaries in the United States and/or other countries. Information is subject to change without notice. Other brand and product names are registered trademarks or trademarks of their respective holders. © NETGEAR, Inc. All rights reserved.

### Technical Support

Thank you for choosing NETGEAR. To register your product, get the latest product updates, get support online, or for more information about the topics covered in this manual, visit the Support website at

<http://support.netgear.com>

Phone (US & Canada only): 1-888-NETGEAR

Phone (Other Countries): Check the list of phone numbers at

[http://support.netgear.com/app/answers/detail/a\\_id/984](http://support.netgear.com/app/answers/detail/a_id/984)

### Statement of Conditions

To improve internal design, operational function, and/or reliability, NETGEAR reserves the right to make changes to the products described in this document without notice. NETGEAR does not assume any liability that may occur due to the use, or application of, the product(s) or circuit layout(s) described herein.

### Revision History

Publication Part Number	Version	Publish Date	Comments
202-10510-03	2.0	August 2012	Second publication

# Contents

## Chapter 1 Introduction

Overview .....	6
Features .....	7
Package Contents .....	8

## Chapter 2 Physical Description

GS716T Front and Back Panel Configuration .....	10
GS724T Front and Back Panel Configuration .....	11
LED Designations .....	12
Port LEDs .....	12
System LEDs .....	13
Device Hardware Interfaces .....	14
RJ-45 Ports .....	14
SFP GBIC Module .....	14
Factory Defaults Button .....	14

## Chapter 3 Applications

Desktop Switching .....	16
-------------------------	----

## Chapter 4 Installation

Step 1: Prepare the Site .....	18
Step 2: Install the Switch .....	19
Install the Switch on a Flat Surface .....	19
Install the Switch in a Rack .....	19
Step 3: Check the Installation .....	20
Step 4: Connect Devices to the Switch .....	21
Step 5: Install an SFP GBIC Module .....	22
Step 6: Apply AC Power .....	23
Step 7: Manage the Switch using a Web Browser or the Smart Control Center Utility .....	24

## Appendix A Troubleshooting

Troubleshooting Chart .....	26
Additional Troubleshooting Suggestions .....	27
Network Adapter Cards .....	27
Configuration .....	27
Switch Integrity .....	27

Auto-Negotiation .....27

**Appendix B Technical Specifications**

**Appendix C Notification of Compliance**

**Index**

# Introduction

---

# 1

Congratulations on the purchase of the NETGEAR Smart Switch. The NETGEAR Smart Switch is a state-of-the-art, high-performance, IEEE-compliant network solution designed for users who require a large number of ports and want the power of Gigabit connectivity to eliminate bottlenecks, boost performance, and increase productivity. To simplify installation, the switch is shipped ready for use out of the box.

This chapter serves as an introduction to the Smart Switch and provides the following information:

- *Overview*
- *Features*
- *Package Contents*

## Overview

This Installation Guide is for the following NETGEAR Smart Switches:

- GS716T – This product offers support for 16 ports of 10/100/1000 Mbps and two Form-factor slots, which support 1000 (1000BASE-SX/LX)/100 Mbps Small Form-factor Pluggable (SFP).
- GS724T – This product offers support for 24 ports of 10/100/1000 and two Form-factor slots, which support 1000 (1000BASE-SX/LX)/100 Mbps SFP.

Using Gigabit ports, high-speed connections can be made to a server or network backbone. For example:

- Linking to high-speed servers
- Providing 10/100/1000 Mbps copper and fiber connectivity

The Smart Switch also provides the benefit of administrative management with a complete package of features for the observation, configuration, and control of the network. With a Web-based Graphical User Interface (GUI), the switch's many capabilities can be viewed and used in a simple and intuitive manner. The switch's management features include configuration for port and switch information, VLAN for traffic control, port trunking for increased bandwidth, IPv6 Management support to enable IPv6 operation over the network port, IPv6 QoS, IPv6 ACL and Class of Service (CoS) for traffic prioritization. These features provide better understanding and control of the network. Initial discovery of the switch on the network requires the Smart Control Center program, a utility that runs on a computer.

The Smart Switch can be free-standing, or rack mounted in a wiring closet or equipment room. It is IEEE-compliant and offers low latency for high-speed networking. All ports can automatically negotiate to the highest speed. This capability makes the switch ideal for environments that have a mix of Ethernet, Fast Ethernet, or Gigabit Ethernet devices. In addition, all RJ-45 ports operate in half-duplex or full-duplex mode. The maximum segment length is 328 feet (100 meters) over Category 5 Unshielded Twisted-Pair (UTP) cable, but much longer for fiber connections using SFP GBIC modules.

## Features

The following list identifies the key features of the NETGEAR Smart Switch.

- 16/24 RJ-45 10/100/1000 Mbps auto sensing Giga switching ports.
- 2 Small Form-factor Pluggable (SFP) GBIC slots which function as combo ports. Combo ports are single ports with two physical connections, SFP fiber and RJ-45 copper. The RJ-45 copper ports corresponding to the Combo ports are the last four 10/100/1000 Mbps auto sensing Giga switching ports on each device. If both devices are plugged in, the fiber connection is active, with fiber port taking priority if both are connected. The following SFP types are supported:
  - 1000BASE-SX
  - 1000BASE-LX
  - 100BASE-FX
- The devices support full NETGEAR Smart Switch functionality.
- The devices provide full compatibility with IEEE standards:
  - IEEE 802.3i, (10BASE-T)
  - IEEE 802.3u (100BASE-TX, 100BASE-FX)
  - IEEE 802.3x (Full-duplex flow control)
  - IEEE 802.3ab (1000BASE-T)
  - IEEE 802.3z (1000BASE-X)
- Auto-sensing and auto-negotiating capabilities for all ports.
- Auto Uplink™ on all ports to make the right connection.
- Automatic address learning function to build the packet-forwarding information table. The table contains up to 8K Media Access Control (MAC) addresses.
- Full-duplex and half-duplex functions for all 10/100/1000 Mbps ports.
- Store-and-Forward transmission to remove bad packets from the network.
- Full-duplex IEEE 802.3x pause frame flow control.
- Active flow control to minimize packet loss/frame drops.
- Half-duplex back-pressure control.
- Per port LEDs, System LEDs.
- Standard 1U high, rack-mountable 17-inch chassis.

## Package Contents

Figure 1 shows the package contents of the NETGEAR GS716T and GS724T Series Smart Switch.

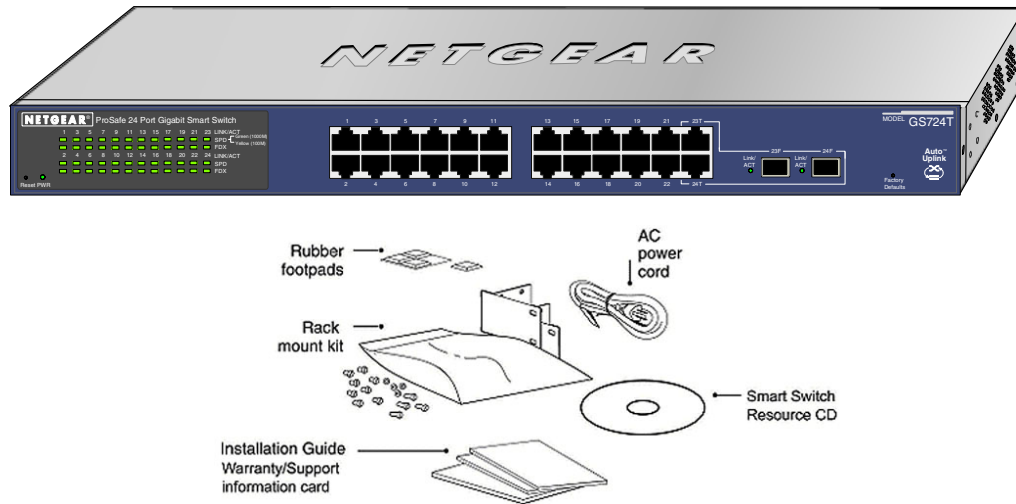

**Figure 1. Package Contents**

Verify that the package contains the following:

- NETGEAR Smart Switch
- Rubber footpads for tabletop installation
- Power cord
- Rack-mount kit for installing the switch in a 19-inch rack
- Quick Installation guide
- Smart Switch Resource CD with Smart Control Center and User's manual
- Warranty/Support Information Card

If any item is missing or damaged, contact the place of purchase immediately.



# Physical Description

---

# 2

This chapter describes the NETGEAR Smart Switch hardware features. Topics include:

- *GS716T Front and Back Panel Configuration*
- *GS724T Front and Back Panel Configuration*
- *LED Designations*
- *Device Hardware Interfaces*

## GS716T Front and Back Panel Configuration

The GS716T is a 24-port 10/100/1000 Mbps + 2 SFP Combo ports Smart Switch. Every RJ-45 port is capable of sensing the line speed and negotiating the operation duplex mode with the link partner automatically

*Figure 2* illustrates the NETGEAR GS716T Smart Switch front panel:

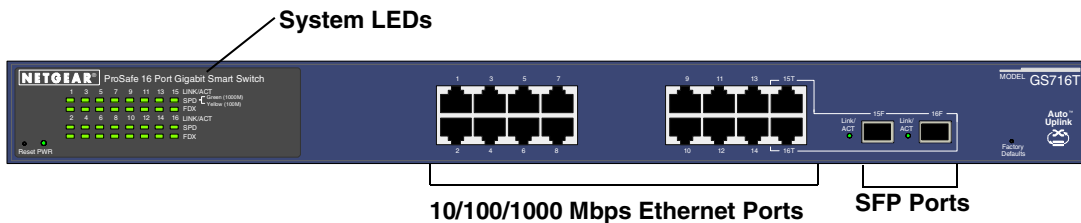

**Figure 2. GS716T Front Panel**

The front panel contains the following:

- 16 RJ-45 connectors for 10/100/1000 Mbps auto sensing Gigabit Ethernet switching ports.
- Two SFP slots for SFP modules supporting 1000 (1000BASE-SX/LX)/100 Mbps SFP.
- Reset button to restart the device.
- Recessed default reset button to restore the device back to the factory defaults.
- Port LEDs
- System LEDs

*Figure 3* illustrates the NETGEAR GS716T Smart Switch back panel:



**Figure 3. GS716T Back Panel**

The back panel contains the following:

- A 100-240VAC/50-60 Hz universal input, which is a standard AC power receptacle for accommodating the supplied power cord.

## GS724T Front and Back Panel Configuration

The GS724T is a 24-port 10/100/1000 Mbps Smart Switch + 2 SFP Combo ports switch. Every RJ-45 port is capable of sensing the line speed and negotiating the operation duplex mode with the link partner automatically

*Figure 4* illustrates the NETGEAR GS724T Smart Switch front panel:

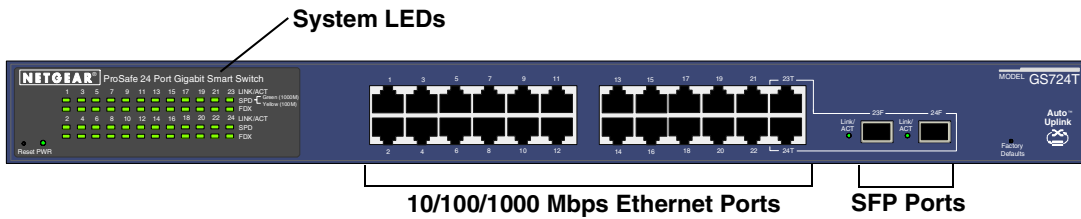

**Figure 4. GS724T Front Panel**

The front panel contains the following:

- 24 RJ-45 connectors for 10/100/1000 Mbps auto-sensing Gigabit Ethernet switching ports.
- Two slots for SFP slots for SFP modules supporting 1000 (1000BASE-SX/LX)/100 Mbps SFP.
- Reset button to restart the device.
- Recessed default reset button to restore the device back to the factory defaults.
- System LEDs

*Figure 5* illustrates the NETGEAR GS724T Smart Switch back panel:



**Figure 5. GS724T Back Panel**

The back panel contains the following:

- A 100-240VAC/50-60 Hz universal input, which is a standard AC power receptacle for accommodating the supplied power cord.

## LED Designations

### Port LEDs

The following table describes the port LED designations.

**Table 1. Port LEDs**

Port	LED	Designation
16/24-10/100/1000 Mbps Ports - 3 LEDs per port	LINK/ACT SPD  FDX	<ul style="list-style-type: none"> <li>• <b>Solid Green</b> - A valid 1000 Mbps link is established on the port.</li> <li>• <b>Flashing Green</b> - Packet transmission or reception is occurring on the port at 1000 Mbps.</li> <li>• <b>Solid Yellow</b> - A valid 10/100 Mbps link is established on the port.</li> <li>• <b>Flashing Yellow</b> - Packet transmission or reception is occurring on the port at 10/100 Mbps.</li> <li>• <b>Off</b> - No 10/100 Mbps link is established on the port.</li> <li>• <b>Solid Green</b> - Full-duplex link is established on the port.</li> <li>• <b>Off</b> - No full-duplex or half-duplex link is established on the port.</li> </ul>
2 SFP Ports - 1 LED per port	SFP LINK/ACT	<ul style="list-style-type: none"> <li>• <b>Solid Green</b> - A valid 1000 Mbps SFP module link is established on the port.</li> <li>• <b>Flashing Green</b> - Packets transmission or reception is occurring on the port at 1000 Mbps.</li> <li>• <b>Solid Yellow</b> - A valid 100 Mbps SFP module link is established on the port.</li> <li>• <b>Flashing Yellow</b> - Packets transmission or reception is occurring on the port at 100 Mbps.</li> <li>• <b>Off</b> - No SPD link is established on the port.</li> </ul>

## System LEDs

The following table describes the system LED designations.

**Table 2. System LEDs**

LED	Designation
Power LED	<ul style="list-style-type: none"><li>• <b>Solid Green</b> - Power is supplied to the switch and the switch is operating normally.</li><li>• <b>Off</b> - Power is disconnected.</li></ul>

## Device Hardware Interfaces

### RJ-45 Ports

RJ-45 ports are auto-sensing ports. When inserting a cable into an RJ-45 port, the switch automatically ascertains the maximum speed (10, 100, or 1000 Mbps) and duplex mode (half-duplex or full-duplex) of the attached device. All ports support only unshielded or shielded twisted-pair (UTP or STP) cable terminated with an 8-pin RJ-45 plug.

To simplify the procedure for attaching devices, all RJ-45 ports support Auto Uplink. This technology allows attaching devices to the RJ-45 ports with either straight-through or crossover cables. When inserting a cable into the switch's RJ-45 port, the switch automatically:

- Senses whether the cable is a straight-through or crossover cable.
- Determines whether the link to the attached device requires a “normal” connection (such as when connecting the port to a computer) or an “uplink” connection (such as when connecting the port to a router, switch, or hub).
- Configures the RJ-45 port to enable communications with the attached device, without requiring user intervention. In this way, the Auto Uplink technology compensates for setting uplink connections, while eliminating concern about whether to use crossover or straight-through cables when attaching devices.

### SFP GBIC Module

The GBIC module bays accommodate standard SFP GBIC modules, such as the AGM731F, AGM732F, or AGM733 from NETGEAR, allowing fiber connections on the network. The module bay is a combo port, sharing a connection with an RJ-45 port. Being a combo port, only one type of connection can be active at any given time. For example, both copper and fiber port cannot be used at the same time. If both connectors are plugged in at the same time, the fiber port will be active.

The SFP GBIC bay accommodates a standard SFP GBIC module.

### Factory Defaults Button

The Smart Switch has a Factory Default button so that you can remove the current configuration and return the device to its factory settings. When you enable the Factory Default button, all settings, including the password, VLAN settings and port configurations will be removed.

# Applications

---

# 3

Your NETGEAR Smart Switch is designed to provide flexibility in configuring your network connections. It can be used as a stand-alone device or with 10 Mbps, 100 Mbps, and 1000 Mbps hubs and switches.

## Desktop Switching

The NETGEAR Smart Switch can be used as a desktop switch to build a small network that enables users to have 1000 Mbps access to a file server. With full-duplex enabled, the switch port connected to the server or computer can provide 2000 Mbps throughput.

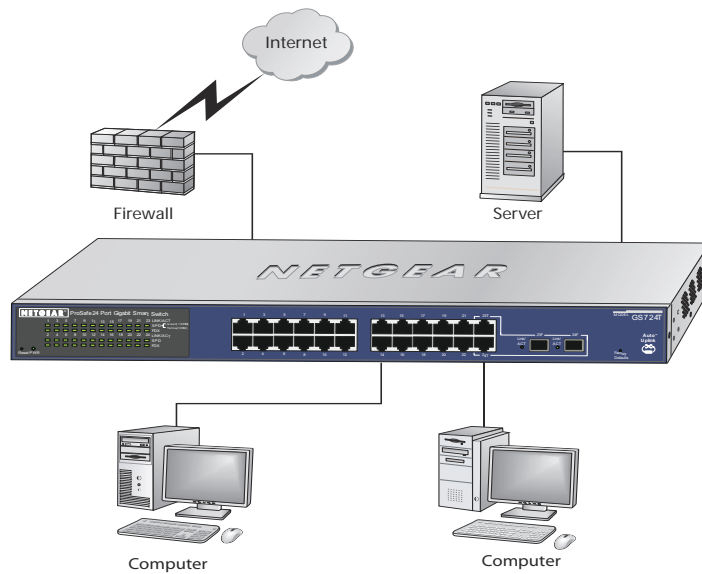

Figure 6. Desktop Switching



# Installation

---

# 4

This chapter describes the installation procedures for your NETGEAR Smart Switch. Switch installation involves the following steps:

*Step 1: Prepare the Site*

*Step 2: Install the Switch*

*Step 3: Check the Installation*

*Step 4: Connect Devices to the Switch*

*Step 5: Install an SFP GBIC Module*

*Step 6: Apply AC Power*

*Step 7: Manage the Switch using a Web Browser or the Smart Control Center Utility*

## Step 1: Prepare the Site

Before you install the switch, ensure the operating environment meets the operating environment requirements in the following table.

**Table 3. Site Requirements**

Characteristics	Requirements
Mounting	<ul style="list-style-type: none"> <li>• <b>Desktop installations</b> - Provide a flat table or shelf surface.</li> <li>• <b>Rack-mount installations</b> - Use a 17-inch (48.3-centimeter) EIA standard equipment rack that is grounded and physically secure. The rack-mount kit supplied with the switch is also required.</li> </ul>
Access	Locate the switch in a position that allows access to the front panel RJ-45 ports, view the front panel LEDs, and access power connector.
Power source	Provide a power source within 6 feet (1.8 meters) of the installation location. Power specifications for the switch are shown in <a href="#">Appendix A</a> . Ensure the AC outlet is not controlled by a wall switch, which can accidentally turn off power to the outlet and the switch.
Environmental	<ul style="list-style-type: none"> <li>• <b>Temperature</b> - Install the switch in a dry area, with ambient temperature between 0 and 55°C (32 and 131°F). Keep the switch away from heat sources such as direct sunlight, warm air exhausts, hot-air vents, and heaters.</li> <li>• <b>Operating humidity</b> - The installation location should have a maximum relative humidity of 90%, non-condensing.</li> <li>• <b>Ventilation</b> - Do not restrict airflow by covering or obstructing air inlets on the sides of the switch. Keep at least 2 inches (5.08 centimeters) free on all sides for cooling. Be sure there is adequate airflow in the room or wiring closet where the switch is installed.</li> <li>• <b>Operating conditions</b> - Keep the switch at least 6 ft. (1.83 m) away from nearest source of electromagnetic noise, such as a photocopy machine.</li> </ul>

## Step 2: Install the Switch

The NETGEAR Smart Switch can be installed on a flat surface or in a standard 19-inch rack.

### Install the Switch on a Flat Surface

The switch ships with four self-adhesive rubber footpads. Stick one rubber footpad on each of the four concave spaces on the bottom of the switch. The rubber footpads cushion the switch against shock/vibrations.

### Install the Switch in a Rack

To install the switch in a rack, use the following procedure (and see [Figure 7, Rack Mount](#) on page 19). To perform this procedure, the 17-inch rack-mount kit supplied with switch is required.

1. Attach the supplied mounting brackets to the side of the switch.
2. Insert the screws provided in the rack-mount kit through each bracket and into the bracket mounting holes in the switch.
3. Tighten the screws with a #1 Phillips screwdriver to secure each bracket.
4. Align the mounting holes in the brackets with the holes in the rack, and insert two pan-head screws with nylon washers through each bracket and into the rack.
5. Tighten the screws with a #2 Phillips screwdriver to secure the switch in the rack.

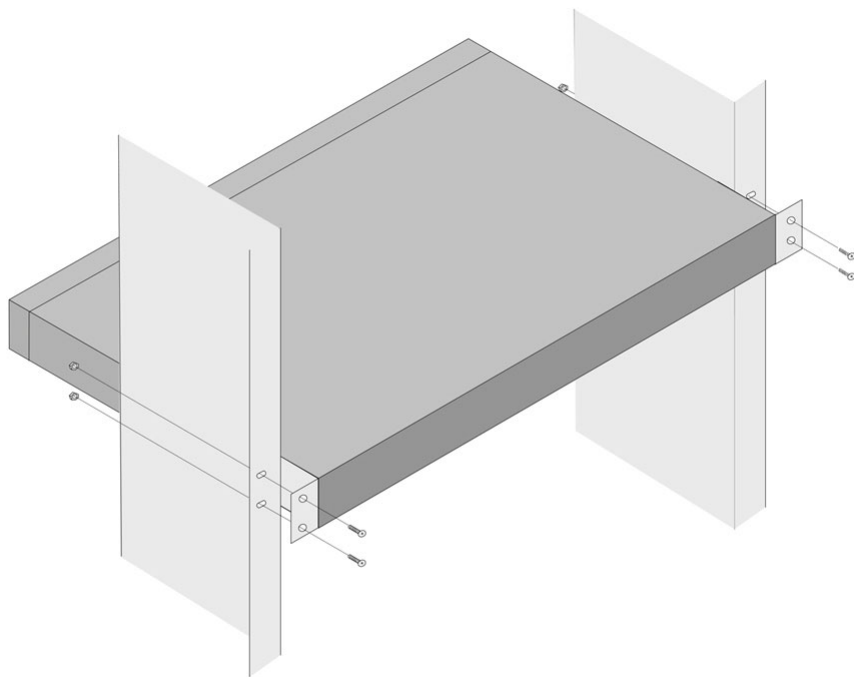

Figure 7. Rack Mount

## Step 3: Check the Installation

Before applying power perform the following:

- Inspect the equipment thoroughly.
- Verify that all cables are installed correctly.
- Check cable routing to make sure cables are not damaged or creating a safety hazard.
- Ensure all equipment is mounted properly and securely.

## Step 4: Connect Devices to the Switch

The following procedure describes how to connect computers to the switch's RJ-45 ports. The NETGEAR Smart Switch contains Auto Uplink™ technology, which allows the attaching of devices using either straight-through or crossover cables.

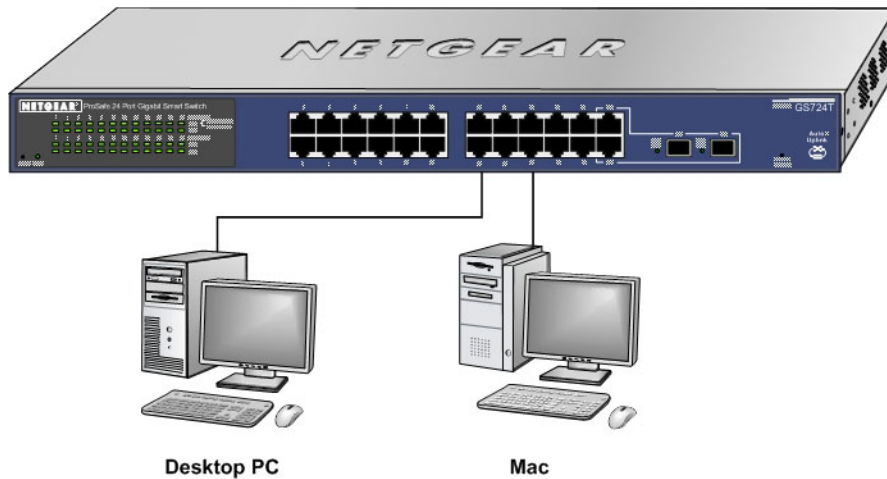

**Figure 8. Connecting Devices to the Switch**

Connect each computer to an RJ-45 network port on the Switch front panel (*Figure 8*). Use Category 5 (Cat5) Unshielded Twisted-Pair (UTP) cable terminated with an RJ-45 connector to make these connections.

---

**Note:** Ethernet specifications limit the cable length between the switch and the attached device to 100 m (328 ft.).

---

## Step 5: Install an SFP GBIC Module

The following procedure describes how to install an SFP Gigabit Ethernet module in the switch's Gigabit module bay. Standard SFP GBIC modules are sold separately from the Smart Switch. If an SFP GBIC module is not being installed at this time, skip this procedure.

To install an SFP GBIC module:

Insert the SFP module into the SFP module bay. Press firmly to ensure the module seats into the connector.

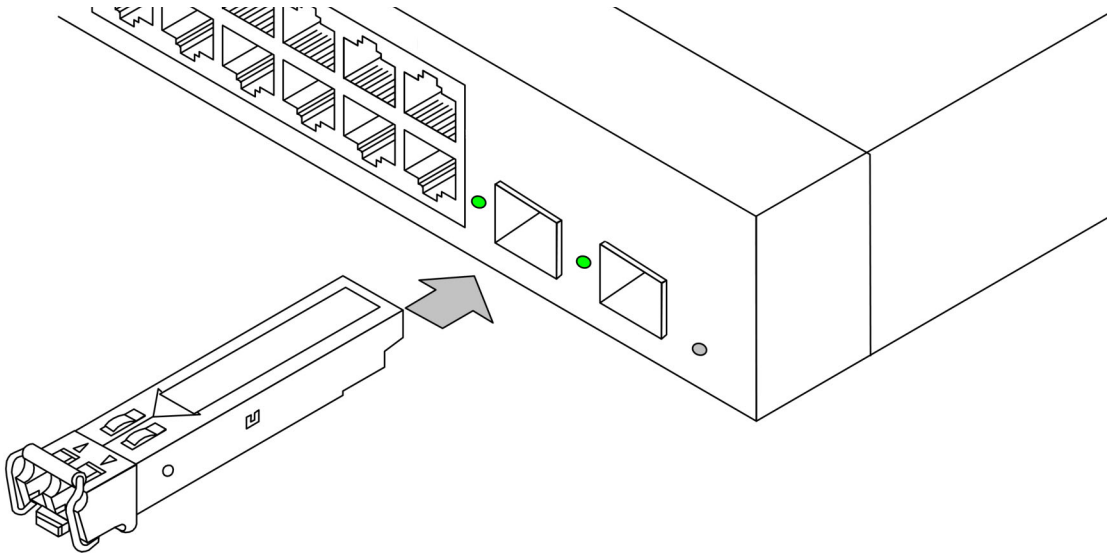

**Figure 9. Install an SFP Gigabit Ethernet Module**

## Step 6: Apply AC Power

NETGEAR Smart Switch does not have an ON/OFF switch. The method of applying or removing AC power is by connecting or disconnecting the power cord. Before connecting the power cord, select an AC outlet that is not controlled by a wall switch, which can turn off power to the switch. After selecting an appropriate outlet, use the following procedure to apply AC power.

1. Connect the female end of the supplied AC power adapter cable to the power receptacle on the back of the switch.
2. Connect the 3-pronged end of the AC power adapter cable to a grounded 3-pronged AC outlet.

When applying power, the Power LED on the switch's front panel is Green.

If the Power LED does not go on, check that the power cable is plugged in correctly and that the power source is good. If this does not resolve the problem, refer to [Appendix A](#).

## Step 7: Manage the Switch using a Web Browser or the Smart Control Center Utility

The NETGEAR Smart Switch contains software for viewing, changing, and monitoring the way it works. This management software is not required for the switch to work. The ports can be used without using the management software. However, the management software enables the setup of VLAN and Trunking features, and also improves the efficiency of the switch, which results in the improvement of its overall performance as well as the performance of the network.

After powering up the switch for the first time, the Smart Switch can be configured using a Web browser or a utility program called Smart Control Center. For more information about managing the switch, see the *GS716T/GS724T Series Software Administration Manual* on the Smart Switch *Resource CD*.

---

**Note:** When the device powers up, there is a default IP address already configured on the device. The default IP address is 192.168.0.239 and subnet mask 255.255.255.0.

---



# Troubleshooting

---



This chapter provides information about troubleshooting the NETGEAR Smart Switch. Topics include the following:

- *Troubleshooting Chart*
- *Additional Troubleshooting Suggestions*

## Troubleshooting Chart

The following table lists symptoms, causes, and solutions of possible problems.

**Table 4. Troubleshooting Chart**

Symptom	Cause	Solution
Power LED is off.	No power is received.	Check the power cord connections for the switch at the switch and the connected device. Ensure all cables used are correct and comply with Ethernet specifications.
Link LED is off or intermittent.	Port connection is not working.	Check the crimp on the connectors and make sure that the plug is properly inserted and locked into the port at both the switch and the connecting device. Ensure all cables used are correct and comply with Ethernet specifications. Check for a defective adapter card, cable, or port by testing them in an alternate environment where all products are functioning.
File transfer is slow or performance degradation is a problem.	Half-duplex or full-duplex setting on the switch and the connected device are not the same.	Make sure the attached device is set to auto-negotiate.
A segment or device is not recognized as part of the network.	One or more devices are not properly connected, or cabling does not meet Ethernet guidelines.	Verify that the cabling is correct. Ensure all connectors are securely positioned in the required ports. Equipment may have been accidentally disconnected.
ACT LED is flashing continuously on all connected ports and the network is disabled.	A network loop (redundant path) has been created.	Break the loop by ensuring that there is only one path from any networked device to any other networked device.

## Additional Troubleshooting Suggestions

If the suggestions in Troubleshooting Chart do not resolve the problem, refer to the troubleshooting suggestions in this section.

### Network Adapter Cards

Ensure the network adapter cards installed in the computers are in working condition and the software driver has been installed.

### Configuration

If problems occur after altering the network configuration, restore the original connections and determine the problem by implementing the new changes, one step at a time. Ensure that cable distances, repeater limits, and other physical aspects of the installation do not exceed the Ethernet limitations.

### Switch Integrity

If required, verify the integrity of the switch by resetting the switch. To reset the switch, remove the AC power from the switch and then reapply AC power. If the problem continues, contact NETGEAR technical support. In North America, call 1-888-NETGEAR. If you are outside of North America, please refer to the support information card included with your product.

### Auto-Negotiation

The RJ-45 ports negotiate the correct duplex mode and speed if the device at the other end of the link supports auto negotiation. If the device does not support auto negotiation, the switch only determines the speed correctly and the duplex mode defaults to half-duplex.

The gigabit port on the Gigabit module negotiates speed, duplex mode, and flow control, provided that the attached device supports auto-negotiation.

# Technical Specifications

---



## *Network Protocol and Standards Compatibility*

IEEE 802.3i 10BASE-T

IEEE 802.3u 100BASE-TX,FX

IEEE 802.3ab 1000BASE-T

IEEE 802.3z 1000BASE-X

IEEE 802.3x flow control

## *Management*

Windows 2000 + XP, Vista; Microsoft Explorer 6.0 or higher

IEEE 802.1Q VLAN

IEEE 802.3ad Link Aggregation

IEEE 802.1D Spanning Tree Protocol

IEEE 802.1W Rapid Spanning Tree Protocol

IEEE 802.1AB

IEEE 802.3ab LLDP

SNMP v1, v2c, and v3

HTTP and HTTPS

IGMP Snooping v1/v2

IEEE 802.1p Class of Service (CoS)

IEEE 802.1s

IEEE 802.1x Guest VLAN

Jumbo Frame Support (9K)

Static LAGs

RMON 1,2,3,9

Static L2 Multicast Filtering  
Voice VLAN  
Protected Ports  
DHCP Filtering  
Cable Test  
Syslog (RFC 3164)  
Persistent log supported  
Port Locking  
Denial of Service Protection (control plane)  
Denial of Service Protection (data plane)  
TACACS+  
RADIUS  
EAPOL Forwarding  
BPDU Flooding  
Auto VoIP  
Auto Video  
Auto DoS  
ACL Wizard  
Management Security  
Smart Control Center Discovery  
Boot code update  
Password management  
IPv6 management  
Text-based config  
Inventory Support (Customized)  
Restore Defaults Push Button  
Restore Defaults via Web  
Standard L2 MIBs support  
User ID configuration  
Authentication login lists  
IPv4 and IPv6 DiffServ

MAC, IPv4 and IPv6 ACL

Dual Image Support

SNTP (Simple Network Time Protocol) 2 servers. Disabled by default.

### ***Interface***

16/24 RJ-45 connectors for 10BASE-T, 100BASE-TX and 1000BASE-T (Auto Uplink™ on all ports).

2 Small Form-factor Pluggable (SFP) slots for SFP module.

### ***LEDs***

Per port (Gigabit): Link/Activity, Speed

Per device: Power

### ***Performance Specifications***

Forwarding modes: Store-and-forward

Bandwidth: 32 Gbps (for GS716T); 48 Gbps (for GS724T)

Address database size: 8K media access control (MAC) addresses per system

Mean Time Between Failure (MTBF): 465,998 hours for GS716T; 401,205 hours for GS724T

### ***Power Supply***

Power Consumption: 16.5W for GS716T, 21.5W for GS724T

100-240VAC/50-60 Hz universal input

### ***Physical Specifications***

Dimensions (H x W x D): 1.7 x 17.3 x 10.2 / 43 x 440 x 260 (in/mm)

Weight: GS716T: 5.64/2.56 (lbs/kg), GS724T: 5.86/2.66 (lbs/kg)

### ***Environmental Specifications***

Operating temperature: 0°C to 55°C (32 to 131°F)

Storage temperature: -20°C to 70°C (28 to 158°F)

Operating humidity: 10%-90% maximum relative humidity, non-condensing

Storage humidity: 5%-95% maximum relative humidity, non-condensing

Operating altitude: 3,000 m (10,000 ft.) maximum

Storage altitude: 3,000 m (10,000 ft.) maximum

***Electromagnetic Emissions***

CE mark, commercial

FCC Part 15 Class A

VCCI Class A

C-Tick

***Electromagnetic Immunity***

EN 55022 (CISPR 22), Class A

***Safety***

CE mark, commercial

UL listed (UL 1950)/cUL IEC950/EN60950

CB and CCC

***Modules***

AGM731F 1000BASE-SX SFP GBIC for multimode fiber

AGM732F 1000BASE-LX SFP GBIC for single mode fiber

AGM733 1000BASE-LZ GBIC for long haul single mode fiber

# Notification of Compliance

---



## NETGEAR Wired Products

### **Regulatory Compliance Information**

This section includes user requirements for operating this product in accordance with National laws for usage of radio spectrum and operation of radio devices. Failure of the end-user to comply with the applicable requirements may result in unlawful operation and adverse action against the end-user by the applicable National regulatory authority.

This product's firmware limits operation to only the channels allowed in a particular Region or Country. Therefore, all options described in this user's guide may not be available in your version of the product.

### **FCC Requirements for Operation in the United States**

#### **FCC Information to User**

This product does not contain any user serviceable components and is to be used with approved antennas only. Any product changes or modifications will invalidate all applicable regulatory certifications and approvals

This device complies with Part 15 of the FCC Rules. Operation is subject to the following two conditions: (1) This device may not cause harmful interference, and (2) this device must accept any interference received, including interference that may cause undesired operation.

#### **FCC Guidelines for Human Exposure**

This equipment complies with FCC radiation exposure limits set forth for an uncontrolled environment. This equipment should be installed and operated with minimum distance of 20 cm between the radiator and your body.

This transmitter must not be co-located or operating in conjunction with any other antenna or transmitter.

#### **FCC Declaration Of Conformity**

We, NETGEAR, Inc., 350 East Plumeria Drive, San Jose, CA 95134, declare under our sole responsibility that the GS716T/GS724T Gigabit Smart Switch complies with Part 15 of FCC Rules.



Operation is subject to the following two conditions:

- This device may not cause harmful interference, and
- This device must accept any interference received, including interference that may cause undesired operation.

### **FCC Radio Frequency Interference Warnings & Instructions**

This equipment has been tested and found to comply with the limits for a Class B digital device, pursuant to Part 15 of the FCC Rules. These limits are designed to provide reasonable protection against harmful interference in a residential installation. This equipment uses and can radiate radio frequency energy and, if not installed and used in accordance with the instructions, may cause harmful interference to radio communications. However, there is no guarantee that interference will not occur in a particular installation.

If this equipment does cause harmful interference to radio or television reception, which can be determined by turning the equipment off and on, the user is encouraged to try to correct the interference by one or more of the following methods:

- Reorient or relocate the receiving antenna.
- Increase the separation between the equipment and the receiver.
- Connect the equipment into an electrical outlet on a circuit different from that which the radio receiver is connected.
- Consult the dealer or an experienced radio/TV technician for help.

Modifications made to the product, unless expressly approved by NETGEAR, Inc., could void the user's right to operate the equipment.

### **Canadian Department of Communications Radio Interference Regulations**

This digital apparatus, GS716T/GS724T Gigabit Smart Switch, does not exceed the Class B limits for radio-noise emissions from digital apparatus as set out in the Radio Interference Regulations of the Canadian Department of Communications.

This Class [B] digital apparatus complies with Canadian ICES-003.

Cet appareil numérique de la classe [B] est conforme à la norme NMB-003 du Canada

### **European Union**

The GS716T/GS724T Gigabit Smart Switch complies with essential requirements of EU EMC Directive 2004/108/EC and Low Voltage Directive 2006/95/EC as supported by applying the following test methods and standards:

- EN55022: 2006 / A1: 2007
- EN55024: 1998 / A1: 2001 / A2: 2003
- EN60950-1: 2005 2nd Edition
- EN 61000-3-2:2006
- EN 61000-3-3:1995 w/A1: 2001+A2: 2005

# Index

## Numerics

1000BASE-LX **7**  
1000BASE-SX **7**  
1000BASE-T **7**  
1000BASE-X **7**  
100-240VAC/50-60 **10**  
100BASE-TX **7**  
10BASE-T **7**  
1U **7**  
8-pin **14**

## A

AC Power **10, 11**  
AGM731F **14**  
AGM732F **14**  
AGM733 **14**  
Applying AC Power **23**  
Attaching Switch to a Rack **19**  
Auto Sensing **7**  
Auto Uplink **14**  
Auto-negotiating **7**  
Auto-sensing **14**

## B

Back-pressure **7**  
Brackets **19**

## C

Category 5 Unshielded Twisted-Pair **6**  
Checking the Installation **20**  
Class of Service **6**  
Combo Port **14**  
Combo Ports **7**  
compliance **32**  
Connecting Devices to the Switch **21**  
Copper **6**  
Crossover **14**

## D

Default IP Address **24**  
Default Reset Button **10, 11**  
Device Hardware Interfaces **14**  
Duplex Mode **14**

## E

Example of Desktop Switching **16**

## F

Factory Default Button **14**  
Factory Defaults **10**  
Fiber Connectivity **6**  
Flat Surface **19**  
Full-duplex **6**

## G

GBIC **6, 14**  
Gigabit Ports **6**

## H

High-speed Servers **6**  
Hz **10, 11**

## I

IEEE 802.3ab **7**  
IEEE 802.3i **7**  
IEEE 802.3u **7**  
IEEE 802.3x **7**  
IEEE 802.3z **7**  
IEEE Standards **7**  
IEEE-compliant **6**  
Installation Guide **8**  
Installing an SFP GBIC Module **22**  
Installing the Switch **19**

## L

LED Designations **12**  
LINK/ACT LED **12**  
Low Latency **6**

## M

MAC **7**  
Media Access Control **7**  
Mounting Holes **19**

## N

Nylon Washers **19**

## O

ON/OFF switch **23**  
Operating Conditions **18**  
Operating Environment **18**  
Operating humidity **18**  
Overview **6**

## P

Package Contents **8**  
Pause Frame Flow Control **7**  
Phillips Screwdriver **19**  
Port LEDs **12**  
Power cord **8**  
Preparing the Site **18**

## R

Rack **19**  
Rack-mount Kit **8, 19**  
Reset Button **10, 11**  
RJ-45 **6**  
RJ-45 Ports **14**  
Rubber footpads **8, 19**

## S

SFP GBIC Module **14**  
SFP LINK/ACT LED **12**  
SFP Module Bay **22**  
Site Requirements **18**  
Small Form-factor Pluggable (SFP) **7**  
Smart Control Center **6**  
Smart Switch Resource CD **8**

Straight-through **14**  
Support Information Card **8**  
System LEDs **13**

## T

technical support **2**  
Temperature **18**  
trademarks **2**  
Traffic Control **6**  
Troubleshooting Chart **26**

## U

User Intervention **14**  
User's Manual **8**  
UTP **21**

## V

Ventilation **18**  
VLAN **6**

## W

Warranty **8**  
Web-based Graphical User Interface **6**