

RangeMax NEXT Wireless-N Modem Router Setup Manual



NETGEAR®

NETGEAR, Inc.
4500 Great America Parkway
Santa Clara, CA 95054 USA

June 2008
208-10257-01
v1.4

©2008 by NETGEAR, Inc. All rights reserved.

Trademarks

NETGEAR, the NETGEAR logo, RangeMax and Smart Wizard are trademarks or registered trademarks of NETGEAR, Inc. Microsoft, Windows, and Windows NT are registered trademarks of Microsoft Corporation. Other brand and product names are registered trademarks or trademarks of their respective holders.

Statement of Conditions

In the interest of improving internal design, operational function, and/or reliability, NETGEAR reserves the right to make changes to the products described in this document without notice.

NETGEAR does not assume any liability that may occur due to the use or application of the product(s) or circuit layout(s) described herein.

Contents

RangeMax NEXT Wireless-N Modem Router Setup Manual

Getting to Know Your Wireless Router	1
Unpacking Your New Router	1
Hardware Features	3
Front Panel	3
Back Panel	5
Router Label	5
Positioning Your Wireless Router	6
Installing Your Wireless-N Modem Router	6
Installing Your Router Using the Smart Wizard	9
Using the Smart Wizard	9
Accessing Your Router After Installation	10
Installing Your Router Manually (Advanced, Mac, and Linux Users)	11
Understanding ADSL Microfilters	12
ADSL Microfilter	12
ADSL Microfilter with Built-In Splitter	12
Connecting Your Wireless-N Modem Router	13
Verifying Your Connection	16
Setting Up Your Router for Internet Access	17
Configuring Your Wireless Network	21
Specifying Wireless Settings	21
Setting Your SSID and Wireless Security Manually	22
Using Push 'N' Connect (WPS) to Configure Your Wireless Network	23
Testing Basic Wireless Connectivity	26
Troubleshooting	29
Basic Functioning	29

Power LED Not On	30
Power LED is Red	30
LAN or ADSL Link LEDs Not On	30
Troubleshooting the Web Configuration Interface	31
Troubleshooting the ISP Connection	32
ADSL link	32
Obtaining an Internet IP Address	33
Troubleshooting PPPoE or PPPoA	33
Troubleshooting Internet Browsing	34
Troubleshooting a TCP/IP Network Using the Ping Utility	35
Testing the LAN Path to Your Router	35
Testing the Path from Your Computer to a Remote Device	36
Restoring the Default Configuration and Password	36
Using the Reset Button	36
Technical Specifications	39
General Specifications	39
Default Configuration	40
Related Documents	43
Registration and Certifications	45

Getting to Know Your Wireless Router

Congratulations on your purchase of a NETGEAR® high-speed wireless router, the RangeMax NEXT Wireless-N Modem Router .

Before you begin installing your router, check the package contents (see [“Unpacking Your New Router” on page 1](#)). Become familiar with the front and back panels of your router—especially the LEDs—and the important information on the router label (see [“Hardware Features” on page 3](#)). Then, read the section on [“Positioning Your Wireless Router” on page 6](#) to ensure that you have selected the best location to install your router.

This chapter describes how to set up the router on your Local Area Network (LAN) and connect to the Internet. It describes how to set up your wireless-N modem router for Internet access and configure basic wireless connectivity.

Unpacking Your New Router

Your router should contain the following items:

- Wireless-N Modem Router
- AC power adapter (varies by region)
- Category 5 (Cat 5) Ethernet cable
- Telephone cable with RJ-11 connector
- Microfilters (quantity and type vary by region)
- *Resource CD*, including:
 - The Smart Wizard Installation Assistant
 - This manual
- Warranty and Support Information cards

If any of the parts are incorrect, missing, or damaged, contact your NETGEAR dealer. Keep the carton, including the original packing materials, in case you need to return the product for repair.

To prepare your router for installation:

1. Carefully peel off the protective film covering both sides of your router (see [Figure 1](#)).

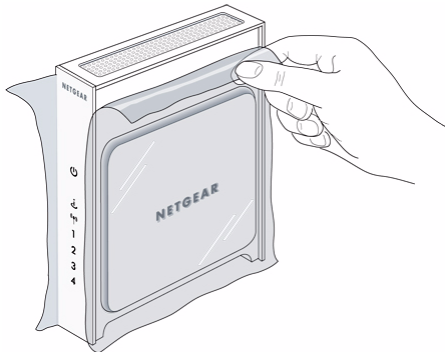

Figure 1

2. Set up your wireless-N modem router by inserting the tabs of the stand (supplied with your router) into the slots on the bottom of your router as shown in [Figure 2](#). Then, remove the protective film covering the LED panel of the router.

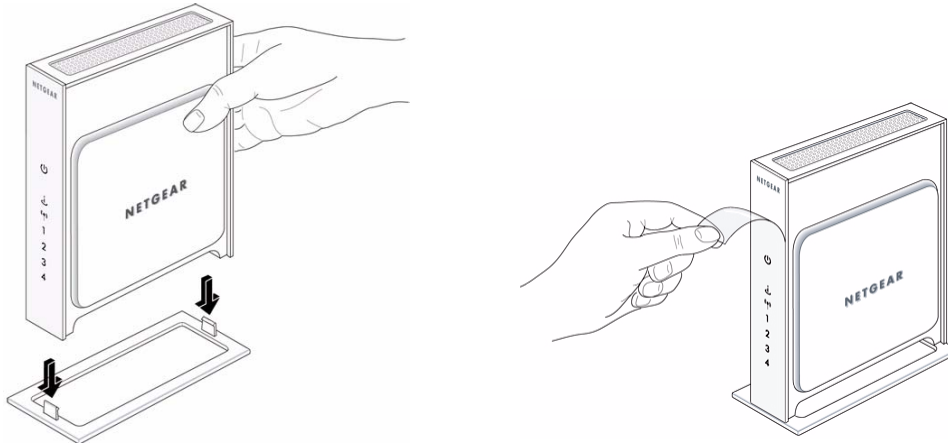

Figure 2

3. Place your router in a suitable area for installation (near an AC power outlet and accessible to the Ethernet cables for your wired computers).



To ensure proper heat dissipation and for router stability, it is important that you connect the stand and place your router in an upright position.

Hardware Features

Before you install and connect your router, take a moment to become familiar with the front and back panels of the router—especially the LEDs on the front panel.

Front Panel

The wireless-N modem router front panel shown below contains status LEDs.

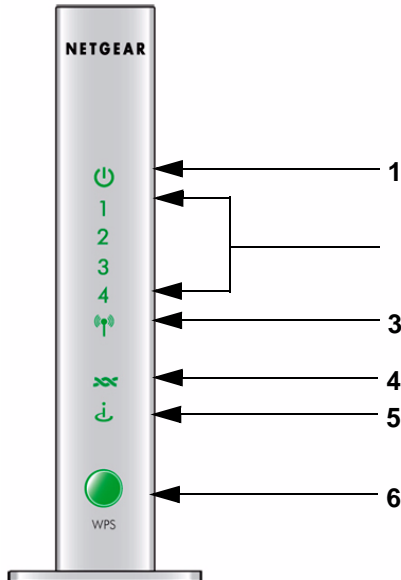

Figure 3

You can use the LEDs to verify various conditions. [Table 1](#) describes each LED.

Table 1. LED Descriptions

Label	LED Activity	Description
1. Power	Solid Green Solid Red Off Factory reset	Power is supplied to the router. POST (Power-On Self-Test) failure or device malfunction Power is not supplied to the router Lights momentarily while the rest button is depressed for 6 seconds, then blinks red three times when the reset button is released, and then turns green as the gateway resets to the factory defaults.

Table 1. LED Descriptions (continued)

Label	LED Activity	Description
2. LAN Ports	Solid Green	The Local port has detected a link with a 100 Mbps device.
	Blinking Green	Data is being transmitted or received at 100 Mbps.
	Solid Amber	The Local port has detected a link with a 10 Mbps device.
	Blinking Amber	Data is being transmitted or received at 10 Mbps.
	Off	No link is detected on this port.
3. Wireless	Solid Green	Indicates that the Wireless port is initialized.
	Blinking Green	Data is being transmitted or received over the wireless link.
	Off	The Wireless Access Point is turned off.
4. ADSL Link	Solid Green	The ADSL port is synchronized with an ISP's network-access device.
	Blinking Amber	Indicates ADSL training—ADSL is synchronizing with the DSLAM.
	Off	The unit is off or there is no IP connection.
5. Internet (WAN)	Solid Green	There is an Internet session. If the session is dropped due to an idle timeout, and an ADSL connection is still present, the light will remain green. If the session is dropped for any other reason, the light will turn off.
	Blinking Green	Data is being transmitted over the ADSL port.
	Red	The wireless ADSL2+ modem router attempted to connect to the Internet but failed.
	Off	No Internet connection detected.
6. Push 'N' Connect	Solid Green	Indicates a (WPS) connection to a WPS-capable device.
	Blinking Green	Attempting to connect to a WPS-capable device.
	Off	No WPS connection made to a WPS-capable device.

Back Panel

The back panel of the wireless-N modem router contains port connections.

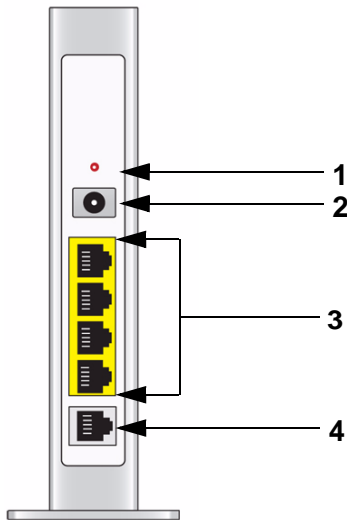

Figure 4

Viewed from top to bottom, the rear panel contains the following elements:

1. Factory Default Reset push button
2. AC power adapter input
3. Four Local Ethernet RJ-45 LAN ports for connecting the router to the local computers
4. RJ-11 ADSL port for connecting the router to an ADSL line

Router Label

The label on the back of the wireless-N modem router shows the router's MAC address, serial number, security PIN, and factory default login information.

The ports on the router are color-coded to distinguish your Internet port from the other four ports that connect to the wired computer(s) on your LAN.

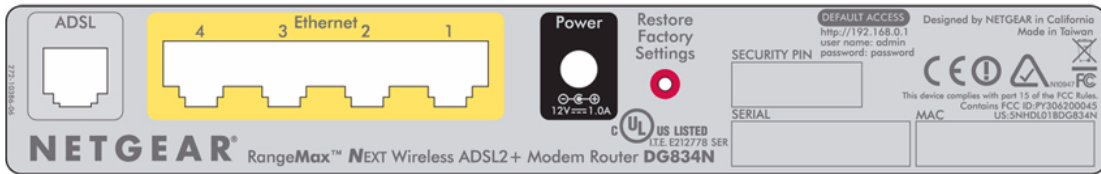

Figure 5

Positioning Your Wireless Router

The wireless-N modem router lets you access your network from virtually anywhere within the operating range of your wireless network. However, the operating distance or range of your wireless connection can vary significantly depending on the physical placement of your router. For example, the thickness and number of walls the wireless signal must pass through may limit the range. For best results, place your router:

- Near the center of the area where your computers and other devices will operate, preferably within line of sight to your wireless devices.
- Accessible to an AC power outlet and near Ethernet cables for wired computers.
- In an elevated location such as a high shelf, keeping the number of walls and ceilings between the wireless-N modem router and your other devices to a minimum.
- Away from electrical devices which are potential sources of interference, such as ceiling fans, home security systems, microwaves, or the base for a cordless phone.
- Away from any large metal surfaces, such as a solid metal door or aluminum studs. Large expanses of other materials such as glass, insulated walls, fish tanks, mirrors, brick, and concrete can also affect your wireless signal.



Failure to follow these guidelines can result in significant performance degradation or an inability to wirelessly connect to the Internet.

Installing Your Wireless-N Modem Router

To help you set up your router and get on the Internet quickly, the *Resource CD* contains a Smart Wizard™. The Smart Wizard walks you through the steps required to connect your router,

microfilters, and PC(s); configure your wireless settings; and enable wireless security for your network. When you have finished, you will be Internet ready!



If you have a Macintosh or Linux system, you need to use the manual installation method (see [“Installing Your Router Manually \(Advanced, Mac, and Linux Users\)”](#) on page 11).

You can set up your wireless-N modem router using one of two methods:.

- **Smart Wizard Setup:** The Smart Wizard setup is available on your *Resource CD*. See [“Installing Your Router Using the Smart Wizard”](#) on page 9 to use the Smart Wizard.
 - This is the easiest option. The wizard guides you through the setup process. It automates many of the steps and verifies that the steps have been successfully completed.
 - Smart Wizard requires a PC running Microsoft Windows..



Before running the Smart Wizard on a corporate PC to set up your home router, check with your company’s network support staff. Corporate network settings or Virtual Private Network (VPN) client software may conflict with the default settings of a home router. If you are unsure about whether there might be a conflict, use a different computer.

- **Manual Setup:** If you cannot or prefer not to use the Smart Wizard, see [“Installing Your Router Manually \(Advanced, Mac, and Linux Users\)”](#) on page 11. For example, if you are connecting to a Mac, are using a Linux operating system, or are technically knowledgeable, select this option. If you choose to use this option and install your router manually, for best results, install and set up your router in this order:
 1. Install and connect your wireless router to your network (see [“Connecting Your Wireless-N Modem Router”](#) on page 13).
 2. Set up your wireless router for Internet access (see [“Setting Up Your Router for Internet Access”](#) on page 17).
 3. Configure your wireless network and select wireless security settings to protect your wireless network (see [“Configuring Your Wireless Network”](#) on page 21).

Installing Your Router Using the Smart Wizard

To use the Smart Wizard, you must be using a PC with Windows Vista, or Windows 2000 or Windows XP with Service Pack 2. The Smart Wizard setup procedure should take about 15 minutes to complete. Before using the Smart Wizard to set up your router, ensure that:

- You have an ADSL Internet service connection through an Internet Service Provider (ISP).
- You have the configuration information provided by your ISP.

Using the Smart Wizard

The NETGEAR Smart Wizard takes you through the procedure to connect your router, ADSL microfilters, and PC(s). It then helps you to configure your wireless settings and enable wireless security for your network. The Smart Wizard guides you through the setup process by automating many of the steps. At each step in the setup process, the Smart Wizard checks to ensure that the steps you perform are successfully completed.

To install your router using the Smart Wizard:

1. Locate the ADSL settings information provided by your Internet Service Provider.
2. Insert the *Resource CD* into your Windows PC. The CD will automatically start and detect the language you are using on your PC. Select a different language option, if you prefer.



If the CD does not automatically start, browse the CD and double-click on .

3. When the **Welcome** screen appears, click **Setup** to start the Smart Wizard. Follow the instructions and prompts to complete the installation.

The Smart Wizard guides you through installing your router, connecting your router to the Internet, configuring your wireless network settings, and selecting the optimum security protection for your network. If you choose not to select a security option during installation,

you can always access the router's user interface later to select a security option (see [“Accessing Your Router After Installation”](#) on page 10).



To ensure optimum performance of your high-speed wireless router, the wireless adapter card for each computer in your network should support the same technology as your router (see the online *User Manual* for more information).

You are now connected to the Internet!

To set up additional wireless computers in your network for router access and to connect to the Internet, see [“Configuring Your Wireless Network”](#) on page 21.

Accessing Your Router After Installation

The Smart Wizard only appears when you first install the router or when the router is in its factory default state (for example, if you have reset the router to its factory default settings). If you want to change the settings after installing and configuring your router, you can click the desktop shortcut—a preconfigured shortcut  placed on your desktop at installation—to open the router management interface.¹ Optionally, you can also open a browser window and log in to the router. After logging in, you can:

- Set up other wireless computers on your network, see [“Configuring Your Wireless Network”](#) on page 21.
- Change settings and configure wireless security, see [“Specifying Wireless Settings”](#) on page 21.

For advanced features not covered in this manual, see the *Reference Manual* on your *Resource CD*. A link to the on-line *Reference Manual* also is available from the router interface.

1. The shortcut icon is installed on your desktop only when using the Smart Wizard installation method.

Installing Your Router Manually (Advanced, Mac, and Linux Users)

Before installing and connecting your router manually, review the list below and make sure that you have all of the necessary information.

- Internet ADSL service connection through an Internet Service Provider (ISP).
- The configuration information your ISP gave you. Depending on how your Internet account was set up, you may need the following information to set up your wireless-N modem router and access the Internet:
 - Host and Domain Name
 - Internet Login Name and Password (frequently an email address and password)
 - Domain Name Server (DNS) Addresses
 - Fixed or Static IP Address

Your ISP should have provided you with all the information needed to connect to the Internet. If you cannot locate this information, ask your ISP.

- ADSL Microfilters (see [“Understanding ADSL Microfilters” on page 12](#)”).
- Your computers set to DHCP enabled.

If you have not already done so:

- Check the package contents of your router to ensure that it is complete (see [“Unpacking Your New Router” on page 1](#)”).
- Select an optimum location for your wireless-N modem router after reviewing the guidelines presented in [“Positioning Your Wireless Router” on page 6.](#)”

Understanding ADSL Microfilters

ADSL technology uses the same wires as your telephone service. However, ADSL adds signals to the telephone lines which create noise in the telephone service. You must use ADSL microfilters to filter out these signals before they reach your telephone.



If you purchased the wireless-N modem router in a country where a microfilter is not included, you must acquire one.

ADSL Microfilter

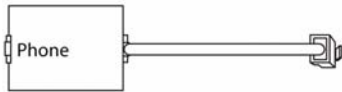

Figure 6

Each device such as a telephone, fax machine, answering machine, or caller ID display will require an ADSL microfilter.



Do not connect the wireless-N modem router to the ADSL line through a microfilter unless the microfilter is a combination microfilter/splitter specifically designed for this purpose. Doing so will prevent block your connection to the Internet. If you have any doubts about this, connect the wireless-N modem router directly to the ADSL line.

ADSL Microfilter with Built-In Splitter

Use an ADSL microfilter with built-in splitter when there is a single wall outlet which must provide connectivity for both the wireless-N modem router and telephone equipment.

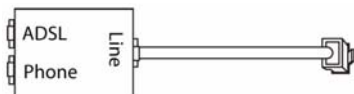

Figure 7

Connecting Your Wireless-N Modem Router

Before you install your wireless-N modem router, make sure that the Internet Protocol (TCP/IP) Property settings on your computer are set to “automatically obtain an IP address” using DHCP and “Obtain DNS server address automatically.” You can check these settings by looking at the TCP/IP Properties of your Internal Network Connections, which are accessible through the Control Panel of your computer. If you are unsure about this, refer to the documentation for your computer or see the link to TCP/IP Addressing in [“Related Documents” on page 43](#).



If you are replacing an existing router, disconnect it completely from your network and set it aside before starting to install your new router.

To connect the wireless-N modem router, the ADSL filter and the computer:

1. Connect an ADSL filter as shown below.



If you purchased the DG834Nv2 in a country where an ADSL filter is not included, you must acquire one.

- Install an ADSL filter for every telephone that uses the same phone line as your wireless-N modem router. Select the appropriate filter(s) for your wireless setup.

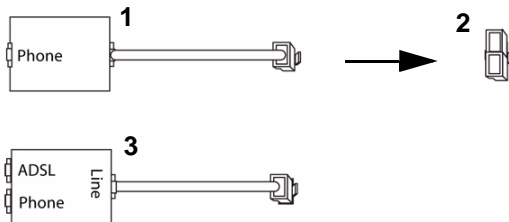

1. One-Line Filter: Use with a phone or fax machine.
2. Splitter: Use with a one-line filter to share an outlet with a phone and the wireless-N modem router.
3. Two-Line Filter with Splitter: Use to share an outlet with a phone and the wireless-N modem router.

Figure 8

- **Two-Line Filter Example.** Insert the two-line filter into the phone outlet and connect the phone to the phone line connector (**A**).

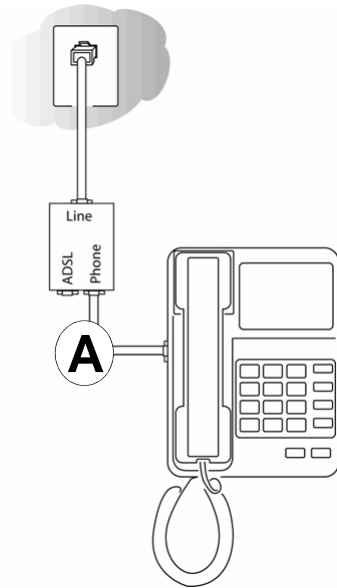

Figure 9



To use a one-line filter with a separate splitter, insert the splitter into the phone outlet, connect the one-line filter to the splitter, and connect the phone to the filter.

2. Connect the wireless-N modem router to the ADSL filter. Using the included phone cable with RJ-11 jacks, connect the ADSL port (**B**) of the wireless-N modem router to the ADSL port (**C**) of the two-line filter

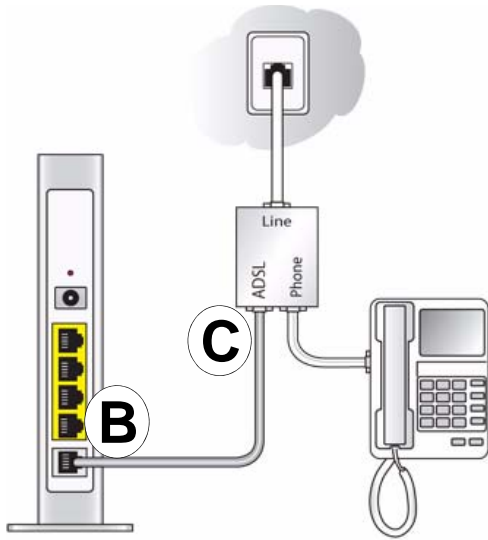

Figure 10



Improperly connecting a filter to your wireless-N modem router will block your ADSL connection.

3. Connect the Ethernet cable (**D**) from a wireless-N modem router LAN port to the Ethernet adapter in your computer.
4. Connect the power adapter to the router and plug it in to a power outlet.

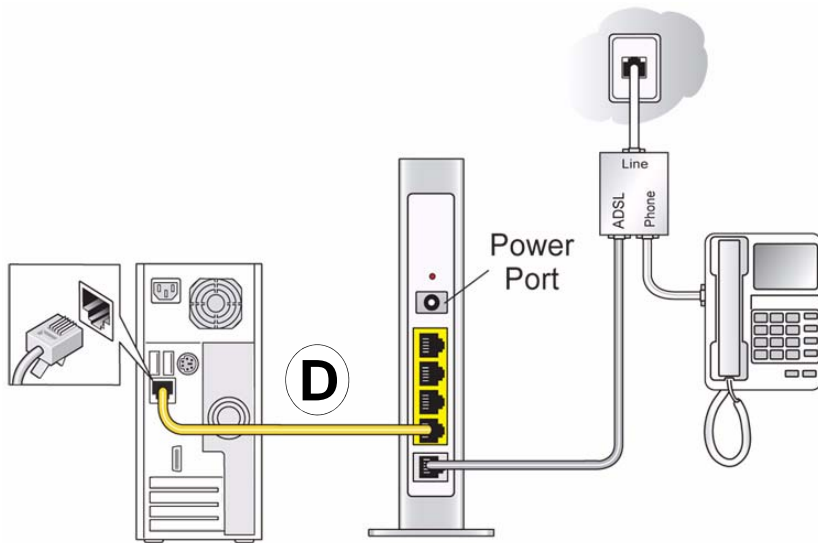





Figure 11

5. Connect any additional wired PCs to your router by inserting an Ethernet cable from a PC into one of the three remaining LAN ports.

Verifying Your Connection

Verify that your router is connected correctly by checking the wireless-N modem router status lights.

-  The power light is lit after turning on the router.
-  The ADSL link light is lit, indicating an ADSL connection.
-  The wireless light is lit after turning on the router.

Now, turn on your computer. If software usually logs you in to your Internet connection, do not run that software. Cancel it if it starts automatically. Verify the following:

-  The local lights (1 through 4) are lit for any connected computers.

Setting Up Your Router for Internet Access

When configuring your wireless router manually, you must log in to your wireless-N modem router to set it up initially and to make any changes to your wireless router's settings later.



The factory default state is reset when you use the Restore Factory Settings button. See [“Restoring the Default Configuration and Password” on page 37](#) for more information.

To access the router:

1. Type **http://192.168.0.1** in the address field of your browser, and then click **Enter**.



You can also enter either of these addresses to connect to your wireless router: **http://www.routerlogin.net** or **http://www.routerlogin.com**.



Figure 12

A login window similar to the one shown in [Figure 13](#) will display.



Figure 13

2. When prompted, enter **admin** for the router User Name and **password** for the router Password, both in lowercase letters. (For security reasons, the router has its own user name and password.)



The router user name and password are not the same as any user name or password you may use to log in to your Internet connection.

The Main menu will display.

3. From the menu options in the left navigation pane, click **Setup Wizard**. The **Setup Wizard** screen will display.

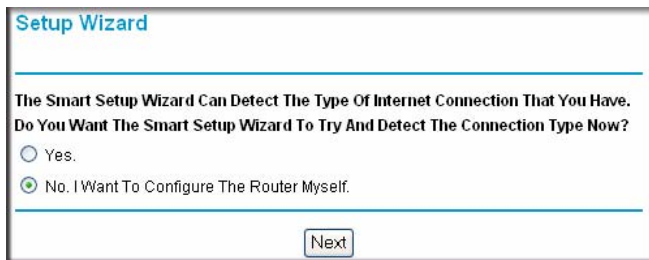

Figure 14

4. Select one of the following options:
 - Select **Yes** to allow the Setup Wizard to detect your Internet connection. When prompted, click **Next**. The wizard will assist you with configuring your wireless router to access the Internet.



If you cannot connect to the wireless router, check the Internet Protocol (TCP/IP) properties in the Network Connections section of your Control Panel. It should be set to obtain *both* IP and DNS server addresses automatically. For assistance, see your computer documentation or see the links in [“Related Documents”](#) on page 43.

- Select **No** to set up the connection yourself. Click **Next** and the **Basic Settings** screen will display. Enter the required information for your ISP connection in the appropriate fields. If you need assistance, follow the **Basic Settings Help** screens on the router interface or see the online *User’s Manual* for this wireless-N modem router.
5. Click **Apply** to save your settings and complete your connection.

You should now be connected to the Internet!

If you do not connect successfully:

- Review your settings and make sure that you have selected the correct options and typed everything correctly.
- Contact your ISP to verify that you have the correct configuration information.
- Read [“Troubleshooting” on page 29](#).

If problems persist, register your NETGEAR product and contact NETGEAR Technical Support.

Configuring Your Wireless Network

After installing your router, you must log into the router to complete your wireless setup. The wireless network settings of the router must match the wireless network settings of any wireless devices that connect wirelessly to the router (such as wireless adapter cards and wireless computers).

For a wireless connection, the router and each wireless computer must use the same SSID, also called the wireless network name, and the same wireless security. NETGEAR strongly recommends that you use wireless security.



Indoors, computers can connect over wireless networks at a range of several hundred feet. This can allow others outside of your immediate area to access your network.

Specifying Wireless Settings

The Wireless Settings screen lets you set your wireless network connections and the wireless security option for your network and router. To configure the wireless network, you can either manually specify your network name (SSID) and your wireless security settings (see [“Setting Your SSID and Wireless Security Manually” on page 22](#)) or, if the clients in your network are WPS capable, you can use Wi-Fi Protected Setup (WPS) to automatically set the SSID and implement WPA/WPA2 security on both the router and the client device (see [“Using Push 'N' Connect \(WPS\) to Configure Your Wireless Network” on page 23](#)).



If you configure the router from a wireless computer and you change the router's SSID, channel, or security settings, you will lose your wireless connection when you click **Apply**. You must then change your computer's wireless settings to match the router's new settings. To avoid this situation, you can use a computer that is connected to the router with an Ethernet cable.

For a complete overview of all the security configurations that can be implemented on this router, see the on-line *User Manual*. A link to the *User Manual* is on the *Resource CD*.

Setting Your SSID and Wireless Security Manually

To specify the wireless settings, you must know the following:

- SSID. The default SSID for the router is NETGEAR.
- The wireless mode (802.11g/b, or 802.11n) that each wireless adapter supports.
- Wireless security option. NETGEAR strongly recommends that you use wireless security. To successfully implement wireless security, check each wireless adapter to determine which wireless security option it supports.

To set up basic wireless connectivity:

1. Log in to the wireless-N modem router at its default LAN address of **http://192.168.0.1** with its default user name of **admin** and default password of **password**, or using whatever LAN address and password you have set up.



You can also enter either of these addresses to connect to your wireless router:
http://www.routerlogin.net or **http://www.routerlogin.com**.

2. On the main menu, select Wireless Settings to display the Wireless Settings screen.

Note that the default SSID is **NETGEAR**.



The SSID of any wireless adapters must match the SSID you configure in the wireless-N modem router. If they do not match, you will not get a wireless connection.

3. Set the Region. Select the region where the router is located.
4. Leave the wireless mode at the default setting of **54 Mbps**.
5. Click **Apply** to save your changes.

To set up your computers for wireless connectivity:

1. Program the wireless settings of each computer or wireless adapter to have the same SSID (wireless network name) as the router.
2. Check that the wireless adapter on each computer can support the mode and security option that you selected. (If you have a question, see the online *User Manual* or review the settings you selected in “[Specifying Wireless Settings](#)” on page 21).

3. Check that the security settings on each wireless device match the security settings of the router. For example, if you selected a security option requiring a passphrase, then the same passphrase must be used for each wireless computer.
4. Check that each wireless computer has a wireless link and is able to obtain an IP address by DHCP from the router.



For a Windows PC, go to the Control Panel and select Network Connections. Check the Wireless Connections Properties and ensure that TCP/IP Properties are set to Obtain an IP address automatically.

To access the Internet from any computer connected to your wireless-N modem router, launch a browser such as Microsoft Internet Explorer or Netscape Navigator. You should see the wireless-N modem router's Internet LED blink, indicating communication to the ISP.

Using Push 'N' Connect (WPS) to Configure Your Wireless Network

If your wireless clients support Wi-Fi Protected Setup (WPS), you can use this feature to configure the router's SSID and security settings and, at the same time, connect the wireless client securely and easily to the router. Look for the  symbol on your client device.¹ WPS automatically configures the SSID and wireless security settings for the router (if the router is in its default state) and broadcasts these settings to the wireless client.



NETGEAR's Push 'N' Connect feature is based on the Wi-Fi Protected Setup (WPS) standard. All other Wi-Fi-certified and WPS-capable products should be compatible with NETGEAR products that implement Push 'N' Connect.

If the router has already been configured manually, and either WPS-PSK or WPA2-PSK security has been enabled, a wireless client can be connected quickly and simply by using the WPS method of connecting to the wireless network. In this case, the existing wireless settings are broadcast to the WPS-capable client. (For more information on setting up a mixed network, see the on-line *User Manual*. A link to the *User Manual* is on the *Resource CD*.)



If you choose to use WPS, the only security methods supported are WPA-PSK and WPA2-PSK. WEP security is not supported by WPS.

1. For a list of other Wi-Fi-certified products available from NETGEAR, go to <http://www.wi-fi.org>.

These instructions assume that you are configuring WPS on the router for the first time and connecting a WPS-capable device.

To set up basic wireless connectivity:

1. Log in to the wireless-N modem router at its default LAN address of **http://192.168.0.1** with its default user name of **admin** and default password of **password**, or using whatever LAN address and password you have set up.



You can also enter either of these addresses to connect to your wireless router:
http://www.routerlogin.net or **http://www.routerlogin.com**.

2. On the router main menu, select Add a WPS Client (computers that will connect wirelessly to the router are clients). The Add WPS Client wizard screen displays. Click **Next**.

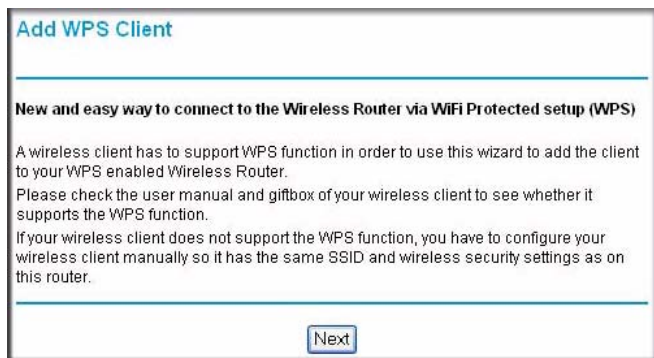

Figure 15

3. Select the method for adding the WPS client. A WPS client can be added using the Push Button method or the PIN method.
 - **Using the Push Button.** This is the preferred method.
 - Select the **Push Button** radio box and either press the WPS Push Button on the side of the router or click the soft WPS Push Button on the screen (as shown below).
 - The router will attempt to communicate with the client; you have 2 minutes to enable WPS from the client device using the client's WPS networking utility.

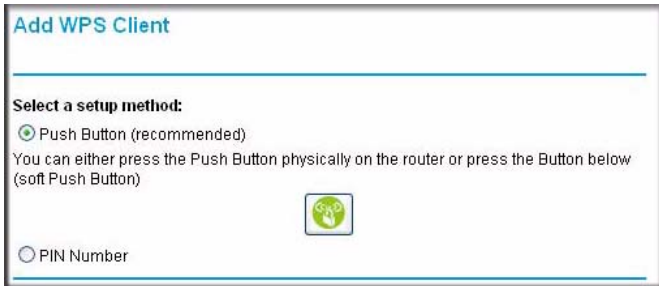

Figure 16

- **Entering a PIN.** If you want to use the PIN method, select the **PIN** radio box. A screen similar to the one shown below displays.
 - Go to your wireless client and, from the client’s WPS utility, obtain the wireless client’s security PIN, or follow the client’s WPS utility instructions to generate a security PIN.
 - Then, enter this PIN in the **Enter Client’s PIN** field provided on the router and click **Next**. You have 4 minutes to enable WPS on the router using this method.

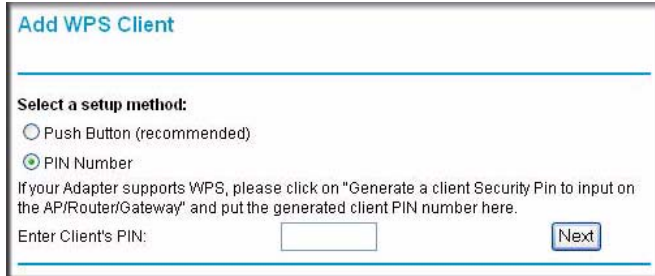

Figure 17

Using either method, the client wireless device will attempt to detect the WPS signal from the router and establish a wireless connection in the time allotted.

- If no connection is detected, then no SSID or security settings are configured on the router.
 - If a connection is established, the router WPS screen displays a message confirming that the wireless client was successfully added to the wireless network. (The router has generated an SSID, implemented WPA/WPA2 wireless security (including a PSK security password) on the router and has sent this configuration to the wireless client.)
4. Note the new SSID and WPA/WPA2 password for the wireless network.

To access the Internet from any computer connected to your wireless-N modem router, launch a browser such as Microsoft Internet Explorer or Netscape Navigator. You should see the wireless-N modem router's Internet LED blink, indicating communication to the ISP.



If you are planning a mixed network of WPS capable devices and non-WPS capable devices, NETGEAR suggests that you set up your wireless network and security settings manually first, and use WPS only for adding additional WPS capable devices.

For more information on setting up your wireless network and configuring your wireless security settings, see the *User Manual*. A link to the on-line *User Manual* is on your *Resource CD*.

Testing Basic Wireless Connectivity

Once you have established basic wireless connectivity, you can enable security settings appropriate to your needs.

To set up and test basic wireless connectivity:

1. Log in to the wireless-N modem router at its default LAN address of **http://192.168.0.1** with its default user name of **admin** and default password of **password**, or using whatever LAN address and password you have set up.
2. Click the Wireless Settings link in the main menu of the wireless-N modem router.
3. Note that the default SSID is **NETGEAR**.



The SSID of any wireless adapters must match the SSID you configure in the wireless-N modem router. If they do not match, you will not get a wireless connection.

4. Set the Region. Select the region in which the wireless interface will operate.
5. Leave the Wireless mode at the default setting of "Up to 270 Mbps". This mode is backward compatible with 802.11b and 802.11g wireless adapters.

6. Click **Apply** to save your changes.



If you are configuring the router from a wireless computer and you change the router's SSID, channel, or security settings, you will lose your wireless connection when you click Apply. You must then change the wireless settings of your computer to match the router's new settings.

7. Configure and test your computers for wireless connectivity.

Program the wireless adapter of your computers to have the same wireless network name (SSID) as the wireless-N modem router. Check that they have a wireless link and are able to obtain an IP address by DHCP from the router.

Your wireless-N modem router is now configured to provide Internet access for your network. Your wireless-N modem router automatically connects to the Internet when one of your computers requires access. It is not necessary to run a dialer or login application such as Dial-Up Networking or Enternet to connect, log in, or disconnect. These functions are performed automatically by the wireless-N modem router as needed.

To access the Internet from any computer connected to your wireless-N modem router, launch a browser such as Microsoft Internet Explorer or Netscape Navigator. You should see the wireless-N modem router's Internet LED blink, indicating communication to the ISP. The browser should begin to display a Web page.

Troubleshooting

This chapter gives information about troubleshooting your wireless-N modem router. After each problem description, instructions are provided to help you diagnose and solve the problem. For the common problems listed, go to the section indicated.

- Is the router on?
Go to [“Basic Functioning” on page 29](#).
- Have I connected the router correctly?
Go to [“Troubleshooting the Web Configuration Interface” on page 31](#).
- I cannot access the router’s configuration with my browser.
Go to [“Troubleshooting Internet Browsing” on page 35](#).
- I have configured the router but I can’t access the Internet.
Go to [“Troubleshooting the ISP Connection” on page 32](#).
- I cannot remember the router’s configuration password.
Go to [“Using the Reset Button” on page 37](#).
- I want to clear the configuration and start over again.
Go to [“Restoring the Default Configuration and Password” on page 37](#).

Basic Functioning

After you turn on power to the router, the following sequence of events should occur:

1. When power is first applied, verify that the Power LED is on (see [“Hardware Features” on page 3](#) for an illustration and explanation of the LEDs).
2. After approximately 10 seconds, verify that:
 - a. The LAN port LEDs are lit for any local ports that are connected.
 - b. The ADSL link LED is lit.

If the ADSL link LED is lit, a link has been established to the connected device. If a LAN port is connected to a 100 Mbps device, verify that the port's LED is green. If the port is 10 Mbps, the LED will be amber.

If any of these conditions does not occur, refer to the appropriate following section.

“Welcome” Page Displays instead of Router Management Interface

This can occur if the CD Setup Wizard does not complete successfully; the unit will stay in “Wizard Mode”. If the “Welcome” page displays instead of the Router Management interface when you try to go to the Internet or log into the Router Management interface, you can bypass the wizard using one of the following methods:

- Log into the Router Management interface at <http://routerlogin.com/basicsetting.htm>.
- Perform a factory reset to take the router out of “Wizard Mode” altogether.

Power LED Not On

If the Power and other LEDs are off when your router is turned on:

- Make sure that the power cord is properly connected to your router and that the power supply adapter is properly connected to a functioning power outlet.
- Check that you are using the power adapter supplied by NETGEAR for this product.

If the error persists, you have a hardware problem and should contact technical support.

Power LED is Red

When the router is turned on, it performs a power-on self test. If the Power LED turns red after a few seconds or at any other time during normal operation, there is a fault within the router. The power LED also turns red when you depress the factory default reset push button, and blinks red 3 times when that button is released. However, in this case, the wireless-N modem router is working normally.

If the power LED turns red to indicate a router fault:

- Cycle the power to see if the router recovers.

If the power LED is still red one minute after power up:

- Cycle the power to see if the router recovers.

- Clear the router's configuration to factory defaults. This will set the router's IP address to 192.168.0.1. This procedure is explained in [“Using the Reset Button” on page 37](#).

If the error persists, you might have a hardware problem and should contact technical support.

LAN or ADSL Link LEDs Not On

If either the LAN LEDs or ADSL Link LED do not light when the Ethernet connection is made, check the following:

- Make sure that the Ethernet cable connections are secure at the router and at the hub or workstation.
- Make sure that power is turned on to the connected hub or workstation.
- Be sure you are using the correct cable: when connecting the ADSL port, use the cable that was supplied with the wireless-N modem router. If the ADSL link LED is still off, this may mean that there is no ADSL service or the cable connected to the ADSL port is bad.

Window Appears Asking You to Reload Firmware

If a window appears with a message asking you to reload the firmware, this indicates that a problem has been detected with the current firmware. Please follow the on-screen instructions to access new firmware and reload the firmware into your router.

Troubleshooting the Web Configuration Interface

If you are unable to access the router's Web Configuration interface from a computer on your local network, check the following:

- If you are using an Ethernet-connected computer, check the Ethernet connection between the computer and the router as described in the previous section.
- Make sure your computer's IP address is on the same subnet as the router. If you are using the recommended addressing scheme, your computer's address should be in the range of 192.168.0.2 to 192.168.0.254. Refer to [“Preparing a Computer for Network Access” on page 43](#) to find your computer's IP address.
- If your computer's IP address is shown as 169.254.x.x., it might be because recent versions of Windows and MacOS generate and assign an IP address if the computer cannot reach a DHCP server. These auto-generated addresses are in the range of 169.254.x.x. If your IP address is in this range, check the connection from the computer to the router and reboot your computer.

- If your router's IP address was changed and you do not know the current IP address, clear the router's configuration to factory defaults. This will set the router's IP address to 192.168.0.1. This procedure is explained in ["Using the Reset Button" on page 37](#).
- Make sure your browser has Java, JavaScript, or ActiveX enabled. If you are using Internet Explorer, click Refresh to be sure the Java applet is loaded.
- Try quitting the browser and launching it again.
- Make sure you are using the correct login information. The factory default login name is **admin** and the password is **password**. Make sure that CAPS LOCK is off when entering this information.

If the router does not save changes you have made in the Web Configuration Interface, check the following:

- When entering configuration settings, be sure to click the **Apply** button before moving to another menu or tab, or your changes are lost.
- Click the Refresh or Reload button in the Web browser. The changes may have occurred, but the Web browser may be caching the old configuration.

Troubleshooting the ISP Connection

If your router is unable to access the Internet, you should check the ADSL connection, then the Internet TCP/IP connection.

ADSL link

If your router is unable to access the Internet, you should first determine whether you have an ADSL link with the service provider. The state of this connection is indicated with the ADSL link LED.

ADSL Link LED Green or Blinking Green

If your ADSL link LED is green or blinking green, then you have a good ADSL connection. You can be confident that the service provider has connected your line correctly and that your wiring is correct.

ADSL Link LED Blinking Amber

If your ADSL link LED is blinking amber, then your wireless-N modem router is attempting to make an ADSL connection with the service provider. The LED should turn green within several minutes.

If the ADSL link LED does not turn green, disconnect all telephones on the line. If this solves the problem, reconnect the telephones one at a time, being careful to use a microfilter on each telephone. If the microfilters are connected correctly, you should be able to connect all your telephones.

If disconnecting telephones does not result in a green ADSL link LED, there may be a problem with your wiring. If the telephone company has tested the ADSL signal at your Network Interface Device (NID), then you may have poor quality wiring in your house.

ADSL Link LED Off

If the ADSL Link LED is off, disconnect all telephones on the line. If this solves the problem, reconnect the telephones one at a time, being careful to use a microfilter on each telephone. If the microfilters are connected correctly, you should be able to connect all your telephones.

If disconnecting telephones does not result in a green ADSL link LED the problem may be one of the following:

- Check that the telephone company has made the connection to your line and tested it.
- Verify that you are connected to the correct telephone line. If you have more than one phone line, be sure that you are connected to the line with the ADSL service. It may be necessary to use a swapper if you ADSL signal is on pins 1 and 4 of the RJ-11 jack. The Wireless-N Modem Router uses pins 2 and 3.

Internet LED is Red

If the Internet LED is red, the device was unable to connect to the Internet. Verify the following:

- Check that your log-in credentials are correct, or that the information you entered on the Basic Settings screen is correct.
- Check with your ISP to verify that the Multiplexing method, VPI, and VCI settings on the ADSL settings screen are correct.



It is possible that this is due to a problem at your ISP.

Obtaining an Internet IP Address

If your wireless-N modem router is unable to access the Internet, and your ADSL link LED is green or blinking green, you should determine whether the wireless-N modem router is able to obtain a Internet IP address from the ISP. Unless you have been assigned a static IP address, your

wireless-N modem router must request an IP address from the ISP. You can determine whether the request was successful using the browser interface.

To check the Internet IP address from the browser interface:

1. Launch your browser and select an external site such as <http://www.netgear.com>.
2. Access the Main Menu of the wireless-N modem router's configuration at <http://192.168.0.1>.
3. Under the Maintenance heading, click on "Router Status" and check that an IP address is shown for the Internet port. If 0.0.0.0 is shown, your wireless-N modem router has not obtained an IP address from your ISP.

If your router is unable to obtain an IP address from the ISP, the problem may be one of the following:

- If you have selected a login program, you may have incorrectly set the Service Name, User Name and Password. See "[Troubleshooting PPPoE or PPPoA](#)" on page 34.
- Your ISP may check for your computer's host name. Assign the computer Host Name of your ISP account to the wireless-N modem router in the browser-based Setup Wizard.
- Your ISP only allows one Ethernet MAC address to connect to Internet, and may check for your computer's MAC address. In this case:
 - Inform your ISP that you have bought a new network device, and ask them to use the router's MAC address; or
 - Configure your router to spoof your computer's MAC address. This can be done in the Basic Settings menu. Refer to the online help in the wireless-N modem router main menu.

Troubleshooting PPPoE or PPPoA

The PPPoE or PPPoA connection can be debugged as follows:

1. Access the Main Menu of the router at <http://192.168.0.1>.
2. Under the Maintenance heading, select the Router Status link.
3. Click the Connection Status button.
4. If all of the steps indicate "OK" then your PPPoE or PPPoA connection is up and working.
5. If any of the steps indicates "Failed", you can attempt to reconnect by clicking "Connect". The wireless-N modem router will continue to attempt to connect indefinitely.

If you cannot connect after several minutes, you may be using an incorrect Service Name, User Name or Password. There also may be a provisioning problem with your ISP.



Unless you connect manually, the wireless-N modem router will not authenticate using PPPoE or PPPoA until data is transmitted to the network.

Troubleshooting Internet Browsing

If your wireless-N modem router can obtain an IP address but your computer is unable to load any Web pages from the Internet:

- Your computer may not recognize any DNS server addresses.

A DNS server is a host on the Internet that translates Internet names (such as www addresses) to numeric IP addresses. Typically your ISP will provide the addresses of one or two DNS servers for your use. If you entered a DNS address during the wireless-N modem router's configuration, reboot your computer and verify the DNS address as described in [“Preparing a Computer for Network Access” on page 43](#). Alternatively, you can configure your computer manually with DNS addresses, as explained in your operating system documentation.

- Your computer may not have the wireless ADSL modem router configured as its TCP/IP default gateway.

If your computer obtains its information from the wireless-N modem router by DHCP, reboot the computer and verify the wireless-N modem router address as described in [“Preparing a Computer for Network Access” on page 43](#).

Troubleshooting a TCP/IP Network Using the Ping Utility

Most TCP/IP terminal devices and routers contain a ping utility that sends an echo request packet to the designated device. The device then responds with an echo reply. Troubleshooting a TCP/IP network is made easy by using the ping utility in your computer.

Testing the LAN Path to Your Router

You can ping the router from your computer to verify that the LAN path to your router is set up correctly.

To ping the router from a PC running Windows 95 or later:

1. From the Windows toolbar, click the Start button and select Run.
2. In the field provided, type Ping followed by the IP address of the router, as in this example:

```
ping 192.168.0.1
```

3. Click **OK**.

You should see a message like this one:

```
Pinging <IP address> with 32 bytes of data
```

If the path is working, you see this message:

```
Reply from < IP address >: bytes=32 time=NN ms TTL=xxx
```

If the path is not working, you see this message:

```
Request timed out
```

If the path is not functioning correctly, you could have one of the following problems:

- Wrong physical connections
 - Make sure the LAN port LED is on. If the LED is off, follow the instructions in [“LAN or ADSL Link LEDs Not On” on page 31](#).
 - Check that the corresponding Link LEDs are on for your network interface card and for the hub ports (if any) that are connected to your workstation and router.
- Wrong network configuration
 - Verify that the Ethernet card driver software and TCP/IP software are both installed and configured on your PC or workstation.
 - Verify that the IP address for your router and your workstation are correct and that the addresses are on the same subnet.

Testing the Path from Your Computer to a Remote Device

After verifying that the LAN path works correctly, test the path from your PC to a remote device. From the Windows run menu, type:

```
PING -n 10 <IP address>
```

where *<IP address>* is the IP address of a remote device such as your ISP’s DNS server.

If the path is functioning correctly, replies as in the previous section are displayed. If you do not receive replies:

- Check that your PC has the IP address of your router listed as the default gateway. If the IP configuration of your PC is assigned by DHCP, this information will not be visible in your PC's Network Control Panel. Verify that the IP address of the router is listed as the TCP/IP default gateway as described in [“Preparing a Computer for Network Access”](#) on page 43.
- Check to see that the network address of your PC (the portion of the IP address specified by the netmask) is different from the network address of the remote device.
- If your ISP assigned a host name to your PC, enter that host name as the Account Name in the Basic Settings menu.

Restoring the Default Configuration and Password

This section explains how to restore the factory default configuration settings, changing the router's administration password to **password** and the IP address to 192.168.0.1. You can erase the current configuration and restore factory defaults in two ways:

- Use the Erase function of the Web Configuration Manager.
- Use the Reset button on the rear panel of the router. Use this method for cases when the administration password or IP address is not known.

Using the Reset Button

To restore the factory default configuration settings without knowing the administration password or IP address, you must use the Default Reset button on the rear panel of the router.

1. Press and hold the Reset button until the Power LED blinks red (about 6 seconds).
2. Release the Default Reset button and wait for the router to reboot. The Power LED will blink red three times and then will turn green when the default configuration settings have been restored.

Technical Specifications

This appendix provides technical specifications for the wireless-N modem router.

General Specifications

Network Protocol and Standards Compatibility		
Data and Routing Protocols:		TCP/IP, RIP-1, RIP-2, DHCP, PPPoE or PPPoA, RFC 1483 Bridged or Routed Ethernet, and RFC 1577 Classical IP over ATM
Power Adapter		
	North America:	120V, 60 Hz, input
	UK, Australia:	240V, 50 Hz, input
	Europe:	230V, 50 Hz, input
	All regions (output):	12 V AC @ 1.0A output
Physical		
	Dimensions:	8.9" x 6.8" x 1.5" 225.5 mm x 172 mm x 39 mm
	Weight:	1.2 lbs. 0.54 kg
Environmental		
	Operating temperature:	0° to 40° C (32° to 104° F)
	Operating humidity:	10% to 90% relative humidity, noncondensing
	Storage temperature:	-20° to 70° C (-4° to 158° F)
	Storage humidity:	5 to 95% relative humidity, noncondensing
Regulatory Compliance		
	Meets requirements of:	FCC Part 15 Class B; VCCI Class B; EN 55 022 (CISPR 22), Class B

Interface Specifications		
	LAN:	10BASE-T or 100BASE-Tx, RJ-45
	WAN:	ADSL, Dual RJ-11, pins 2 and 3 T1.413, G.DMT, G.Lite

Default Configuration

You can use the reset button located on the front of your device to reset all settings to their factory defaults. This is called a hard reset. To perform a hard reset, push and hold the reset button for three seconds. Your device will return to the factory configuration settings shown in the table below.

Feature		Default Behavior
Router Login		
	User Login URL	http://www.routerlogin.net or http://www.routerlogin.com
	User Name (case sensitive)	admin
	Login Password (case sensitive)	password
Internet Connection		
	WAN MAC Address	Use Default address
	WAN MTU Size	1500
	Port Speed	AutoSense
Local Network (LAN)		
	Lan IP	192.168.0.1
	Subnet Mask	255.255.255.0
	RIP Direction	None
	RIP Version	Disabled
	RIP Authentication	None
	DHCP Server	Enabled
	DHCP Starting IP Address	192.168.0.2
	DHCP Ending IP Address	192.168.0.254
	DMZ	Disabled
	Time Zone	GMT

Feature		Default Behavior
	Time Zone Adjusted for Daylight Saving Time	Disabled
	SNMP	Disabled
Firewall		
	Inbound (communications coming in from the Internet)	Disabled (except traffic on port 80, the http port)
	Outbound (communications going out to the Internet)	Enabled (all)
	Source MAC filtering	Disabled
Wireless		
	Wireless Communication	Enabled
	SSID Name	NETGEAR
	Security	Disabled
	Broadcast SSID	Enabled
	Transmission Speed	Auto ^a
	Country/Region	United States (in North America; otherwise, varies by region)
	RF Channel	11 until the region is selected
	Operating Mode	Up to 130 Mbps
	Data Rate	Best
	Output Power	Full
	Access Point	Enabled
	Authentication Type	Open System
	Wireless Card Access List	All wireless stations allowed

a. Maximum Wireless signal rate derived from IEEE Standard 802.11 specifications. Actual throughput will vary. Network conditions and environmental factors, including volume of network traffic, building materials and construction, and network overhead, lower actual data throughput rate.

Related Documents

This appendix provides links to reference documents you can use to gain a more complete understanding of the technologies used in your NETGEAR product.

Document	Link
Internet Networking and TCP/IP Addressing	http://documentation.netgear.com/reference/enu/tcpip/index.htm
Wireless Communications	http://documentation.netgear.com/reference/enu/wireless/index.htm
Preparing a Computer for Network Access	http://documentation.netgear.com/reference/enu/wsdhcp/index.htm
Virtual Private Networking (VPN)	http://documentation.netgear.com/reference/enu/vpn/index.htm
Glossary	http://documentation.netgear.com/reference/enu/glossary/index.htm

Registration and Certifications

Product Registration, Support, and Documentation

Register your product at <http://www.NETGEAR.com/register>. You must register before you can use our telephone support service. Product updates and Web support are always available by going to: <http://kbserver.netgear.com/>.

Setup documentation is available on the CD, on the support website, and on the documentation website. When the wireless-N modem router is connected to the Internet, click the KnowledgeBase link to view support information or click the Documentation link to view the online *User Manual* for this wireless-N modem router.

Maximum Wireless Signal Rate Derived from IEEE Standard 802.11 Specifications

Actual data throughput will vary. Network conditions and environmental factors, including volume of network traffic, building materials and construction, and network overhead, lower actual data throughput rate.

Federal Communications Commission (FCC) Compliance Notice: Radio Frequency Notice

This equipment has been tested and found to comply with the limits for a Class B digital device, pursuant to part 15 of the FCC Rules. These limits are designed to provide reasonable protection against harmful interference in a residential installation. This equipment generates, uses, and can radiate radio frequency energy and, if not installed and used in accordance with the instructions, may cause harmful interference to radio communications. However, there is no guarantee that interference will not occur in a particular installation. If this equipment does cause harmful interference to radio or television reception, which can be determined by turning the equipment off and on, the user is encouraged to try to correct the interference by one or more of the following measures:

- Reorient or relocate the receiving antenna.
- Increase the separation between the equipment and receiver.
- Connect the equipment into an outlet on a circuit different from that to which the receiver is connected.
- Consult the dealer or an experienced radio/TV technician for help.

