



# AT&T Mobile Hotspot Elevate 4G

## User Guide



**SIERRA**  
WIRELESS™

2400154  
Rev 1



## Important Notice

Due to the nature of wireless communications, transmission and reception of data can never be guaranteed. Data may be delayed, corrupted (i.e., have errors) or be totally lost. Although significant delays or losses of data are rare when wireless devices such as the AT&T Mobile Hotspot Elevate 4G are used in a normal manner with a well-constructed network, the AT&T Mobile Hotspot Elevate 4G should not be used in situations where failure to transmit or receive data could result in damage of any kind to the user or any other party, including but not limited to personal injury, death, or loss of property. Sierra Wireless accepts no responsibility for damages of any kind resulting from delays or errors in data transmitted or received using the AT&T Mobile Hotspot Elevate 4G, or for failure of the AT&T Mobile Hotspot Elevate 4G to transmit or receive such data.

## Safety and Hazards

Do not operate the AT&T Mobile Hotspot Elevate 4G in areas where blasting is in progress, where explosive atmospheres may be present, near medical equipment, near life support equipment, or any equipment which may be susceptible to any form of radio interference. In such areas, the AT&T Mobile Hotspot Elevate 4G **MUST BE POWERED OFF**. The AT&T Mobile Hotspot Elevate 4G can transmit signals that could interfere with this equipment.

Do not operate the AT&T Mobile Hotspot Elevate 4G in any aircraft, whether the aircraft is on the ground or in flight. In aircraft, the AT&T Mobile Hotspot Elevate 4G **MUST BE POWERED OFF**. When operating, the AT&T Mobile Hotspot Elevate 4G can transmit signals that could interfere with various onboard systems.

The driver or operator of any vehicle should not operate the AT&T Mobile Hotspot Elevate 4G while in control of a vehicle. Doing so will detract from the driver or operator's control and operation of that vehicle. In some states and provinces, operating such communications devices while in control of a vehicle is an offence.

## Limitation of Liability

The information in this manual is subject to change without notice and does not represent a commitment on the part of Sierra Wireless. SIERRA WIRELESS AND ITS AFFILIATES SPECIFICALLY DISCLAIM LIABILITY FOR ANY AND ALL DIRECT, INDIRECT, SPECIAL, GENERAL, INCIDENTAL, CONSEQUENTIAL, PUNITIVE OR EXEMPLARY DAMAGES INCLUDING, BUT NOT LIMITED TO, LOSS OF PROFITS OR REVENUE OR ANTICIPATED PROFITS OR REVENUE ARISING OUT OF THE USE OR INABILITY TO USE ANY SIERRA WIRELESS PRODUCT, EVEN IF SIERRA WIRELESS AND/OR ITS AFFILIATES HAS BEEN ADVISED OF THE POSSIBILITY OF SUCH DAMAGES OR THEY ARE FORESEEABLE OR FOR CLAIMS BY ANY THIRD PARTY.

Notwithstanding the foregoing, in no event shall Sierra Wireless and/or its affiliates aggregate liability arising under or in connection with the Sierra Wireless product, regardless of the number of events, occurrences, or claims giving rise to liability, be in excess of the price paid by the purchaser for the Sierra Wireless product.

## **Patents**

This product may contain technology developed by or for Sierra Wireless Inc. This product includes technology licensed from QUALCOMM® 3G. This product is manufactured or sold by Sierra Wireless Inc. or its affiliates under one or more patents licensed from InterDigital Group.

## **Copyright**

© 2011 Sierra Wireless. All rights reserved.

## **Trademarks**

Sierra Wireless™, and the Sierra Wireless logo are trademarks of Sierra Wireless. LTE™ is a trademark of ETSI, AT&T, the AT&T logo and all other AT&T marks contained herein are trademarks of AT&T Intellectual Property and/or AT&T affiliated companies. All other marks contained herein are the property of their respective owners.



# Contents

<b>Get Started</b> .....	<b>8</b>
Know Your Device .....	8
Power Button .....	9
Mute Switch .....	9
LCD .....	9
Power LED .....	12
Included Accessories .....	12
Optional Accessories .....	12
Power Sources .....	12
Set Up and Connect to the Internet .....	13
Connect to the Internet .....	13
Homepage .....	14
Security Credentials .....	16
<b>Use Your Mobile Hotspot</b> .....	<b>17</b>
Set Auto Connect Options .....	17
View Data Usage .....	18
Enable / Disable Wi-Fi .....	19
View / Block Connected Users .....	19
Add a Wireless Device to your Wi-Fi Network .....	20
View SMS Messages and Alerts .....	22
Use the GPS Feature .....	23
Battery Settings .....	24
Extend Battery Life .....	24
Set Audio Alerts .....	26
Change Device Security Settings .....	27
View Details About Your Mobile Hotspot .....	28
Use the microSD Card .....	28
Recharge the Battery .....	30
Replace the SIM Card .....	31

---

<b>Advanced Settings</b> .....	<b>33</b>
Do not Automatically Install Driver for USB Tethering .....	33
Export / Import Router Options .....	33
Set Display Options .....	34
Set Audio Alerts .....	35
View and Save Device Information .....	36
View WAN Information .....	37
Set Connection Preferences .....	37
Enable SIM Security .....	38
View Wi-Fi Status and List of Connected Devices .....	39
Set Wi-Fi Network Options .....	39
Set Wi-Fi Security Options .....	41
Set MAC Filter Mode .....	42
Enable Port Forwarding .....	42
Enable VPN Passthrough .....	44
Set Router LAN Options .....	44
<b>Frequently Asked Questions</b> .....	<b>46</b>
<b>Troubleshooting</b> .....	<b>49</b>
Reset the Mobile Hotspot .....	51
Alerts .....	52
<b>Specifications</b> .....	<b>56</b>
Mechanical Specifications .....	56
Environmental Specifications .....	56
<b>Regulatory and Safety Information</b> .....	<b>57</b>
Notice .....	57
Safety and Hazards .....	57
Regulatory Information for North America .....	58

**Index . . . . . 60**

# 1: Get Started

1

This chapter provides an overview of the AT&T Mobile Hotspot Elevate 4G\* features, and instructions on how to set up your mobile hotspot and connect to the Internet.

## Know Your Device

Your mobile hotspot enables you to create a Wi-Fi access point anywhere in the AT&T coverage area. You can use that Wi-Fi access point to connect your laptop and other Wi-Fi capable devices to AT&T's mobile broadband network and connect to the Internet.

You can also use your mobile hotspot in tethered mode by connecting it to your laptop with the USB cable to access the Internet.

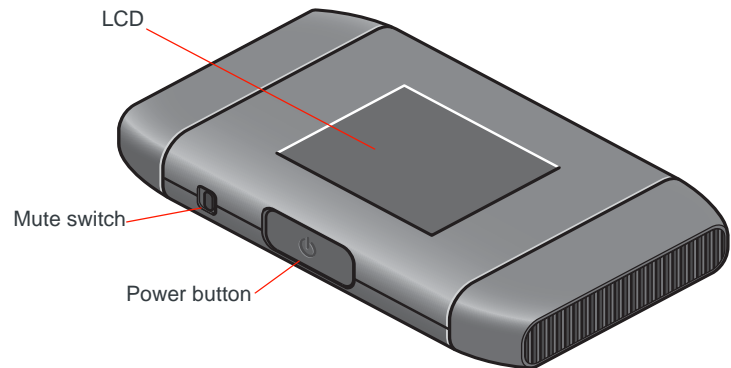

\*. Limited 4G LTE availability in select markets. 4G speeds delivered by HSPA+ (with enhanced backhaul) and LTE, where available. Compatible data plan required. LTE is a trademark of ETSI. Learn more at [att.com/network](http://att.com/network).



## Power Button

Desired result	Action
Turn mobile hotspot on	Press and hold the power button for a few seconds.
Turn mobile hotspot off	Press and hold the power button for a few seconds.
Wake up LCD screen	Press and quickly release the power button.
View WPS instructions	Double-press the power button.
Respond to prompts on the LCD screen	Press and quickly release the power button when prompted to do so by the LCD screen. (This is used to confirm an action.)

## Mute Switch

The mobile hotspot automatically beeps when the battery is low, when you receive a message, etc. To turn these beeps off, move the mute switch so the red rectangle is visible. On the homepage, <http://att.elevate>, you can customize your hotspot to beep when specific changes in status occur. For more information, see [Set Audio Alerts](#) on page 26.

## LCD

As well as providing setup information (Wi-Fi SSID (Network Name) and Wi-Fi Key) the mobile hotspot LCD displays:

- Instructions during setup
- Status messages such as “Searching for network”, “Connected”, etc.
- Status icons (See [Icons on the LCD Screen](#) on page 10 for details.)
- Data Usage meter
- Network name
- Error messages (See [Alerts](#) on page 52 for troubleshooting suggestions.)
- Wi-Fi Protected Setup (WPS) instructions—a fast, easy way to connect WPS-enabled devices to your Wi-Fi network

To personalize the mobile hotspot and change the settings, connect to AT&T’s mobile broadband network and go to the homepage (<http://att.elevate>).





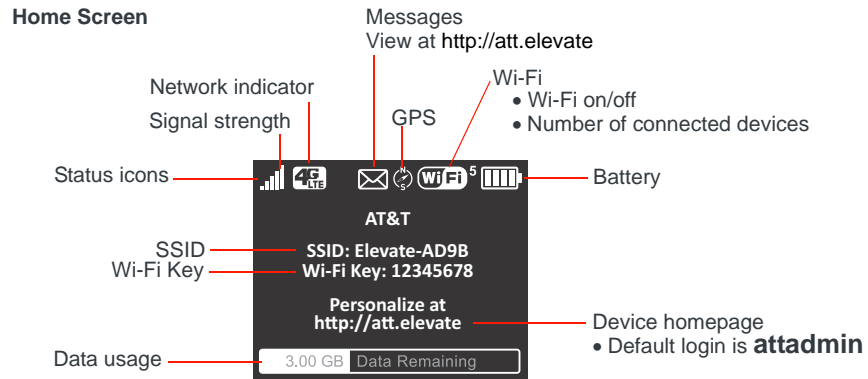









## Icons on the LCD Screen





The icons on the LCD screen indicate the status of the mobile hotspot.



To access the Wi-Fi Protected Setup (WPS) screen, double-press the power button.

Icon	Indicates
	Signal strength The more bars, the stronger the RF signal.
	No signal.

Icon	Indicates
       	<p>The type of network available.*</p> <p>4GLTE —LTE  4G—HSPA, HSPA+  E—EDGE  G—GPRS</p> <p>If the Network icon has a white background, the hotspot is connected to the network.</p> <p>If the Network icon has a black background, service is available, but the hotspot is not connected to the network.</p> <p>For network connection instructions, see <a href="#">Set Up and Connect to the Internet</a> on page 13.</p> <p>* 4G LTE Network Indicator</p> <p>Your 4G LTE wireless device will display one of the following network indicators to let you know which of AT&amp;T's wireless networks you are connected to. A network indicator does not necessarily mean that you will experience any particular upload or download data speeds. Actual speeds depend upon a variety of factors, including the device, network utilization, file characteristics, terrain, etc. Learn more at <a href="http://www.wireless.att.com/learn/articles-resources/wireless-terms.jsp">http://www.wireless.att.com/learn/articles-resources/wireless-terms.jsp</a>, your AT&amp;T Wireless Customer Agreement, Section 3.2 Where and How Does AT&amp;T Service Work?</p> <p><b>4G LTE:</b> Connected to AT&amp;T's 4G LTE network.</p> <p><b>4G:</b> Connected to AT&amp;T's HSPA+ network. AT&amp;T's HSPA+ network is capable of delivering 4G speeds when combined with enhanced backhaul. Your wireless device cannot distinguish between HSPA+ cell sites combined with enhanced backhaul and those without enhanced backhaul. Enhanced backhaul is available in limited areas. However, availability is increasing with ongoing backhaul deployment. Learn more at <a href="http://att.com/network">att.com/network</a>.</p> <p><b>E:</b> Connected to AT&amp;T's EDGE/2G network</p>
	<p><b>Messages</b></p> <p>You have messages from AT&amp;T or alerts (generated by the device) that indicate a change in the device's status. To view your messages and/or alerts, go to the homepage (<a href="http://att.elevate">http://att.elevate</a>) and click the Messages icon.</p>
	<p><b>GPS</b></p> <p>When the needle on the GPS icon flashes, the mobile hotspot is trying to obtain a satellite fix or is tracking a location.</p>
 	<p><b>Wi-Fi</b></p> <p>The number beside the Wi-Fi icon shows the number of users (devices) connected to your Wi-Fi network.</p> <p>Wi-Fi radio is disabled.</p> <p>You can enable Wi-Fi on the device homepage. See <a href="#">The Wi-Fi radio is disabled icon appears on the LCD screen</a>. on page 49.</p>
 	<p><b>Battery status</b></p> <p>Indicates the charge status of the battery</p> <p>4 bars —80–100%  1 bar — 10–29%</p> <p>Battery outline (no bars) — 0–9%  Recharge immediately.</p>

Icon	Indicates
	Battery charging.
	No battery. The mobile hotspot is powered on and connected to the AC charger.
	The battery is charging through a USB connection.
	The exclamation mark (!) in the battery outline indicates that the battery is not recharging because the device is too hot to charge. Make sure there is room for air to circulate around the device. If the problem persists, move the device to a cooler environment.

## Power LED

The blue LED on the top of the mobile hotspot flashes:

- Slowly to indicate that it is powered on
- Quickly when the firmware is being updated

## Included Accessories

- Micro USB cable—Used mainly for recharging the battery, although you can also use it to tether the mobile hotspot to your computer
- AC adapter—Used with the USB cable to recharge the battery or to power the mobile hotspot from a wall socket

For more information, see [Recharge the Battery](#) on page 30.

## Optional Accessories

Additional accessories are available from [www.sierrawireless.com/wheretobuy/onlinestore/default.aspx](http://www.sierrawireless.com/wheretobuy/onlinestore/default.aspx).

## Power Sources

You can power your mobile hotspot from:

- Rechargeable battery included with the mobile hotspot
- USB port on your computer
- Wall socket using the AC adapter and USB cable

---

## Set Up and Connect to the Internet

### Install the Battery

1. Insert the battery as shown in the illustration. Ensure that the gold contacts on the battery are lined up with the gold contacts on the device.

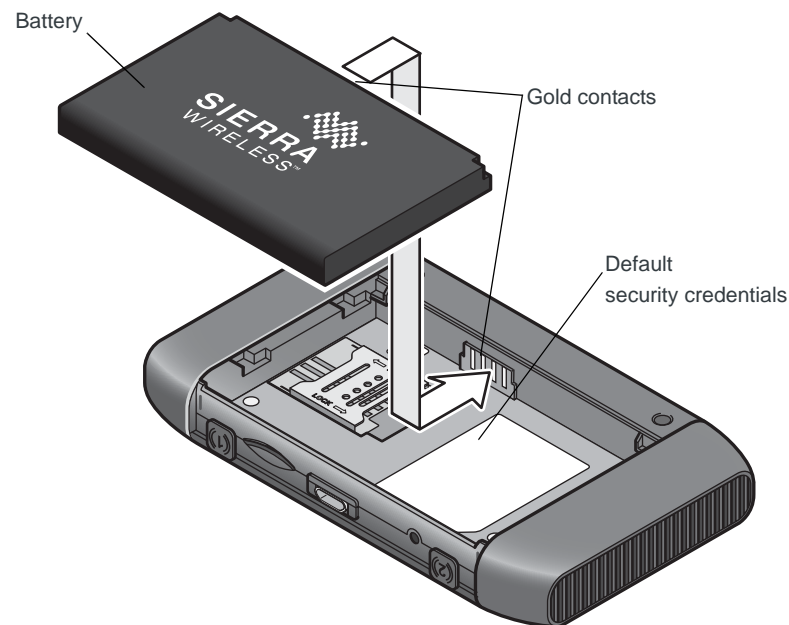

2. Replace the back cover.

---

*Note: The battery comes partially-charged and ready to go. You do not need to charge it fully unless you wish to. When the battery needs recharge, follow the instructions in [Recharge the Battery](#) on page 30.*

---

### Connect to the Internet

---

*Note: Your mobile hotspot does not need to be connected to the computer with the USB cable to connect to the Internet. The USB cable is used mainly for recharging the battery. (You can also connect to the Internet with the mobile hotspot tethered to the laptop with the USB cable.)*

---

To connect to the Internet:

1. Turn on the mobile hotspot.  
Press and hold the power button for a few seconds.

The first time you connect a computer to the mobile hotspot network, the LCD screen displays the message “Connect your computer to Wi-Fi network”. The Wi-Fi SSID (Network Name) and the Wi-Fi Key are shown on the LCD screen.

---

*Note: The LCD screen may go into sleep mode to save power. To wake up the LCD screen, press and quickly release the power button.*

---

2. Connect your computer or other device to your Wi-Fi network.
  - a. On your computer, view the list of available Wi-Fi networks.
  - b. Select the Wi-Fi SSID (Network Name) displayed on the mobile hotspot LCD screen, and connect to it.
  - c. When prompted, enter your Wi-Fi Key, as it appears on the mobile hotspot LCD screen.
3. Launch your browser to surf the Internet.

Optional: To personalize your mobile hotspot go to <http://att.elevate>.

---

*Note: To make changes to the mobile hotspot settings on the homepage, you must first log in as Administrator. Type **attadmin** in the Admin Login box.*

---

## Homepage

Your mobile hotspot comes configured, perfectly secure and ready to use, but if you want to change the security settings, the Wi-Fi SSID (Network Name) and other settings, go to your mobile hotspot's homepage.

The homepage URL (<http://att.elevate>) is shown on the LCD during setup. You can also find it in the Quick Start Guide that came with your mobile hotspot.

To make changes to the settings on the homepage, you must be logged in as Administrator (default Admin Login is **attadmin**).

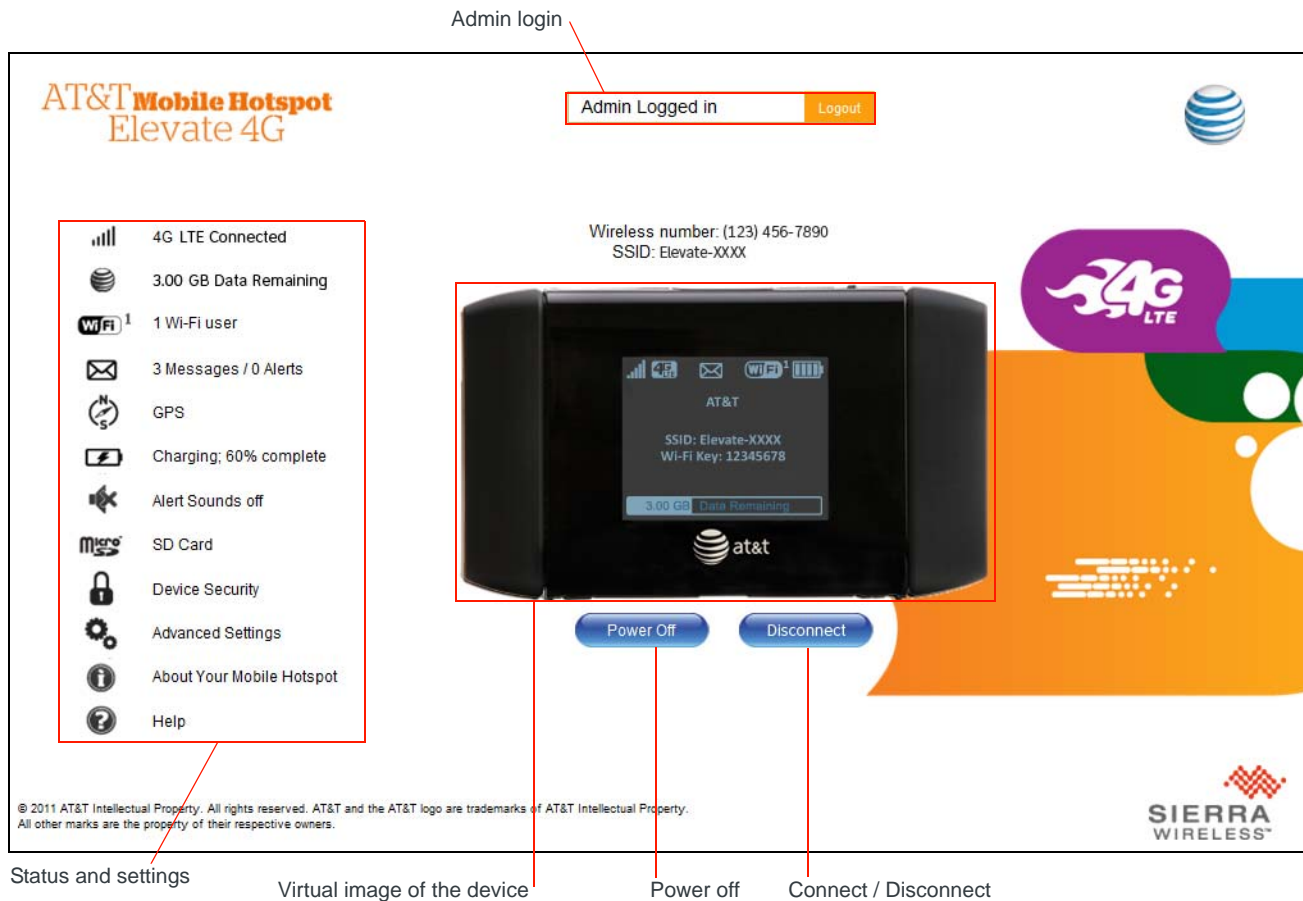

You can view some information about the device without being logged in as Administrator, but to view detailed information and to change any settings and use some features, you must be logged in as Administrator.

To log in as Administrator:

1. Place your cursor in the Admin Login box and type **attadmin** (the default Admin Login).
2. Click OK.

Once you are logged in with the default Admin Login, you can view detailed information and change mobile hotspot settings, such as:

- Change the SSID, Wi-Fi Key, Admin Login, and Wi-Fi encryption
- Set autoconnect options
- Set GPS options
- Use GPS to track or map your location and find nearby amenities
- Set battery options
- View data usage
- Set audio alerts
- Change advanced settings such as security settings and router options

## Security Credentials

Two passwords are associated with the mobile hotspot:

- **Wi-Fi Key**— Used to connect your computer or other Wi-Fi device to your mobile hotspot network. This Key is unique to your device. It is displayed on the main mobile hotspot LCD screen. If the screen is blank (a power-saving feature), press and quickly release the power button to view the information on the screen. The default Wi-Fi Key is also printed on a label under the battery, and is shown on the LCD screen.
- **Admin Login**— Used to log into the homepage as Administrator. You must be logged in as Administrator to use certain features and to make changes to your mobile hotspot settings. The default Admin Login, **attadmin**, is printed on a label under the battery. The Admin Login can be 5 – 31 characters.



## 2: Use Your Mobile Hotspot

This chapter provides information on how to use your mobile hotspot.

*Note:* To change settings you need to be logged in as Administrator. See [Set Up and Connect to the Internet](#) on page 13.

### Set Auto Connect Options

By default, the mobile hotspot automatically connects to AT&T's mobile broadband network. You can change this feature so that the mobile hotspot automatically connects to another network when you are roaming, or to never auto connect.

To select the auto connect options:

1. On the Mobile Hotspot Homepage, log in as Administrator.
2. Click the Signal Strength icon (  ).

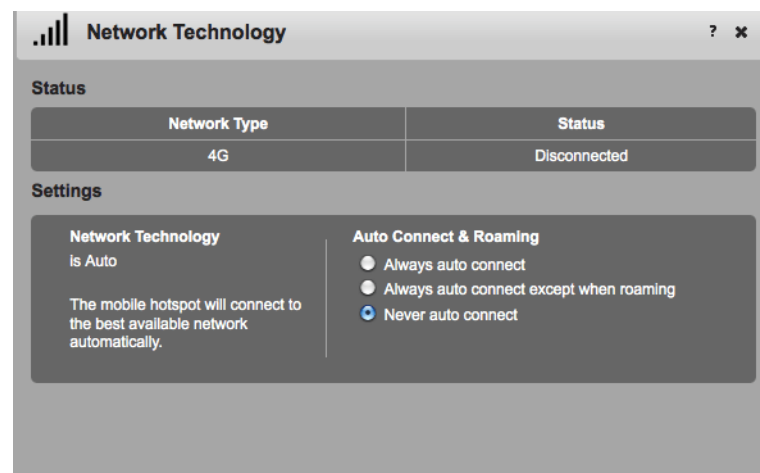

3. Under Auto Connect & Roaming, select the desired option:
  - Always auto connect—The mobile hotspot automatically attempts to connect to the mobile broadband network when powered on. You may incur additional roaming charges if you are outside of the AT&T coverage area.
  - Always auto connect except when roaming—The mobile hotspot automatically attempts to connect only to AT&T's mobile broadband network when powered on (default).
  - Never auto connect—The mobile hotspot will not attempt to automatically connect to the mobile broadband network when powered on.

If you choose this option, press the power button and follow the instructions on the LCD screen to connect, or go to the homepage (<http://att.elevate>) and click Connect. See [page 13](#) for more information.
4. Click Save. (Save button appears once you make a selection.)

## View Data Usage

You can view an estimate of your data usage (not accurate for billing purposes) on the homepage and on the LCD screen.

**On the LCD screen:**

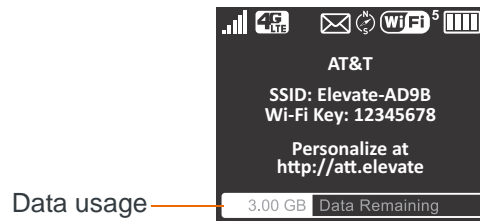

**On the homepage:**

1. Go to the homepage and log in as Administrator.
2. Click the AT&T Globe icon (🌐) on the left side of the screen.
3. The bar graph shows your data usage.

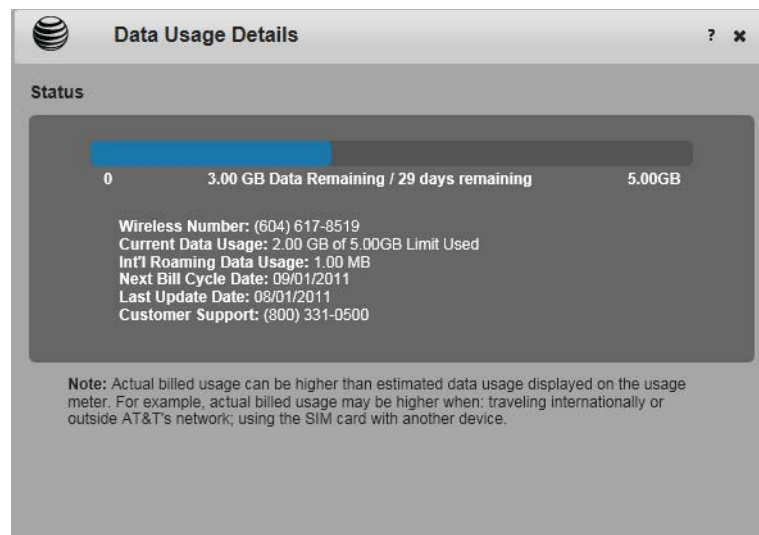

The billing cycle (typically a month) is available on your bill.

## Enable / Disable Wi-Fi

By default, Wi-Fi is enabled, but if your place of business does not allow Wi-Fi or for any reason you want to disable Wi-Fi and use the mobile hotspot only in the tethered mode, the mobile hotspot gives you that option.

To enable / disable your Wi-Fi network:

1. On the Mobile Hotspot Homepage, log in as Administrator.
2. Click the Wi-Fi icon ().

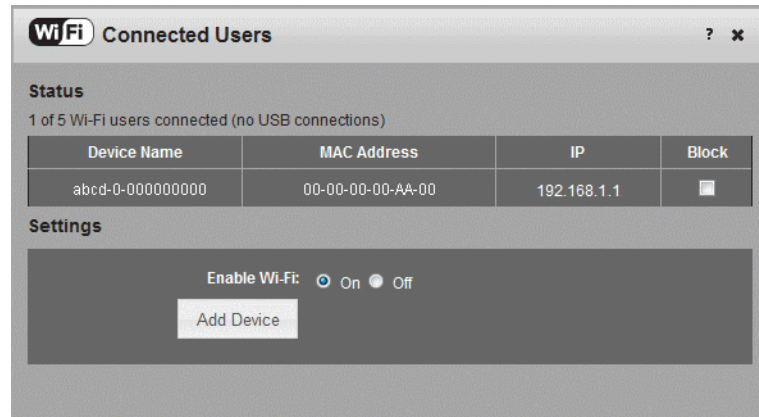

3. Under Settings, select the desired option.
4. Click Save. (Save button appears once you make a selection.)

## View / Block Connected Users

To view a list of devices connected to your mobile hotspot and block undesired users:

1. On the Mobile Hotspot Homepage, log in as Administrator.
2. Click the Wi-Fi icon ().

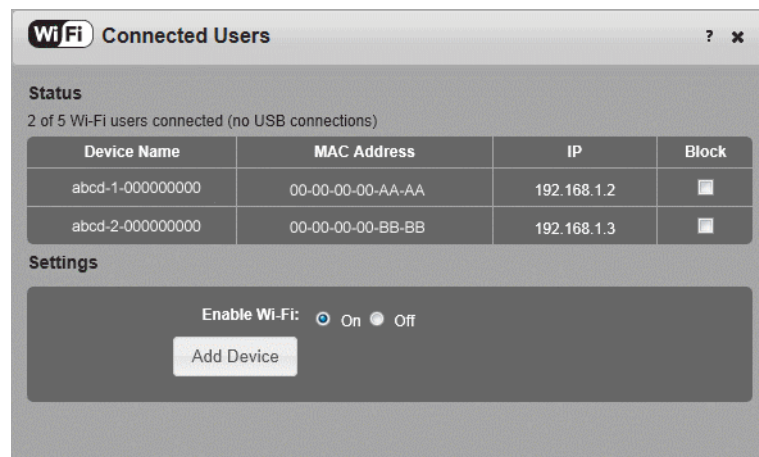

If you notice a user or Wi-Fi device that you do not recognize, you can block that device from connecting to your Wi-Fi network.

To block a user (or device):

1. Select the box beside the device in the Block column.
2. Click Save. (Save button appears once you make a selection.)

To unblock a user and allow that device access to your network, see [Set MAC Filter Mode](#) on page 42.

## Add a Wireless Device to your Wi-Fi Network

You can connect up to five wireless devices such as smart phones, laptops, tablets, digital cameras, printers, gaming consoles, and digital picture frames to your mobile hotspot network.

You can use the Mobile Hotspot Homepage or the device LCD screen (double-press the power button to view WPS instructions) to add additional wireless devices to your Wi-Fi network.

### From the Mobile Hotspot Homepage

To add devices using the Mobile Hotspot Homepage:

1. On the Mobile Hotspot Homepage, log in as Administrator.
2. Click the Wi-Fi icon (<sup>1</sup>).

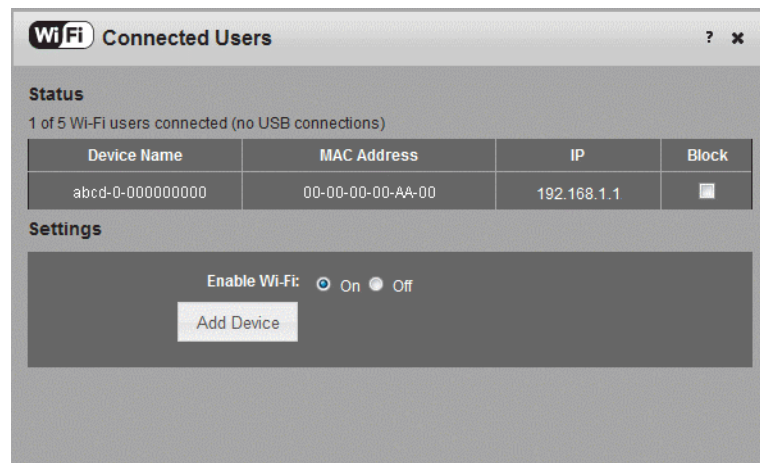

3. Click the Add Device button.

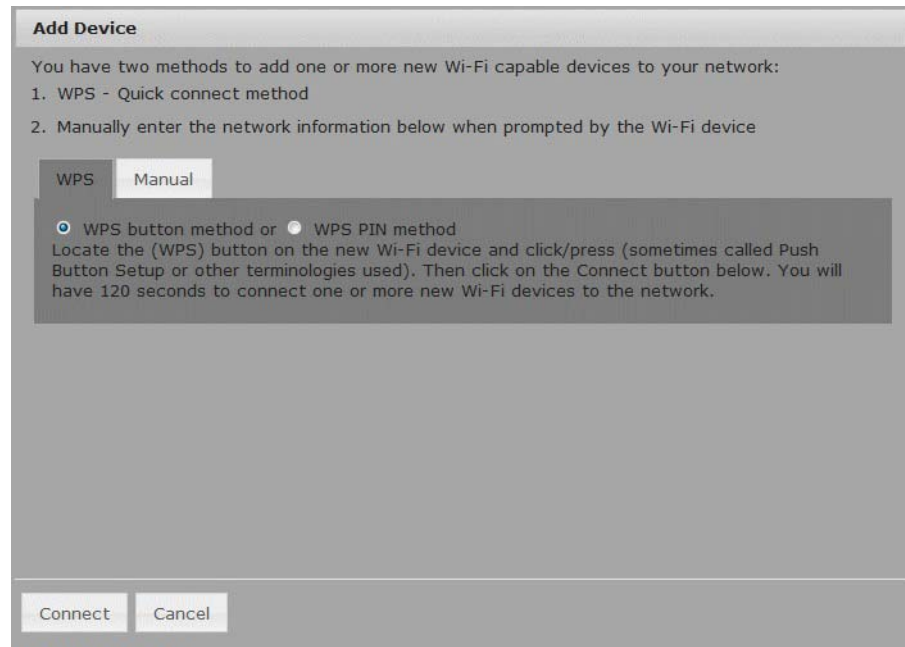

4. Select WPS— For WPS-enabled Wi-Fi devices or Manual—For any Wi-Fi device
  - If you choose the WPS button method:
    - a. Click the Connect button.
    - b. Within 2 minutes, press the WPS button on the wireless device you want to connect.

Your mobile hotspot and the wireless device will communicate and establish the connection.

If you choose WPS PIN method, you'll be asked to enter a PIN to connect to your Wi-Fi network.

If you choose the Manual option:

    - a. Open the Wi-Fi menu on the device you want to connect and view the list of available networks.
    - b. Select the mobile hotspot SSID (Wi-Fi network name) displayed on the LCD screen (e.g. Elevate-xxx).
    - c. Select Connect and enter the Wi-Fi Key displayed on the LCD screen.

## From the Mobile Hotspot LCD

You can also connect using the LCD screen without going to the homepage.

To connect a wireless device using the device LCD:

### WPS Method

1. On your mobile hotspot, double-press the power button to view the WPS Setup screen.
2. When the WPS Setup screen appears, press the power button to enable WPS.

3. Within 2 minutes, press the WPS button on the wireless device you want to connect.

Your mobile hotspot and the wireless device will communicate and establish the connection.

#### Manually

1. On your wireless device, view the list of available Wi-Fi networks.
2. Connect to the network that corresponds to your mobile hotspot network, as displayed on the LCD.
3. When prompted, enter the Wi-Fi Key for your mobile hotspot network. The Wi-Fi Key is displayed on the mobile hotspot LCD screen. If the screen has turned off to save power, press and quickly release the power button to wake up the screen.

## View SMS Messages and Alerts

Your mobile hotspot can receive SMS messages from AT&T and displays alerts to advise you of the device status. The message icon (✉) on the device LCD indicates that you have a message or alert.

To view the message / alert:

1. On the Mobile Hotspot Homepage, log in as Administrator.
2. Click the Messages / Alerts icon (✉).

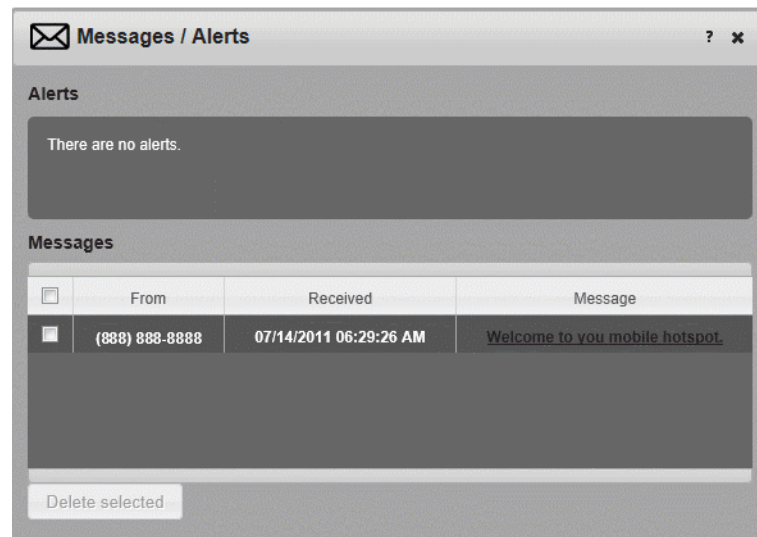

3. Double-click the message or alert subject line to view the entire message / alert.

To delete a message, select the desired message and then click Delete.

---

*Note: By default, you receive an audio alert when the mobile hotspot receives an SMS message / alert. For more information on Audio alerts, see [Set Audio Alerts](#) on page 26.) You cannot delete alerts. They are deleted automatically when the device status changes.*

---

## Use the GPS Feature

1. On the Mobile Hotspot Homepage, log in as Administrator.
2. Click the GPS icon (  ).

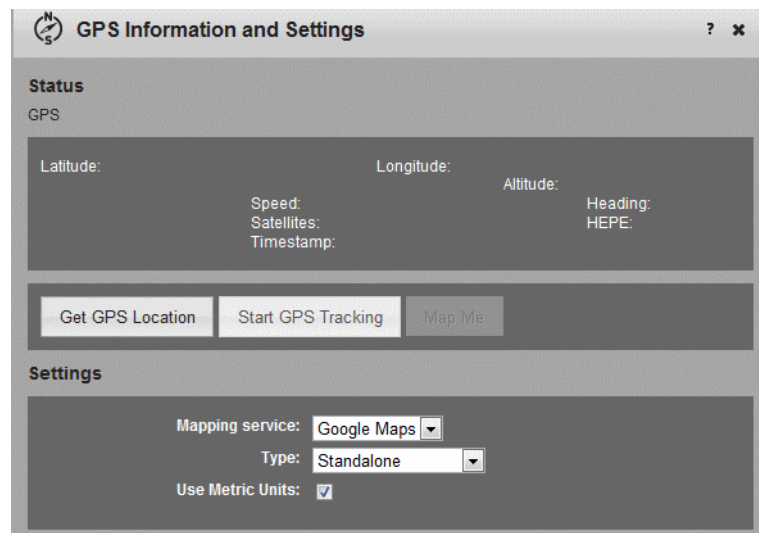

3. If desired, select the GPS type:
  - Standalone— Uses only radio signals from satellites (default)
  - A-GPS-MS Based — Assisted GPS — Uses network resources to help locate and use satellite signals faster. A-GPS is also better at acquiring a GPS fix in poor signal conditions.
4. Optional: For metric units, select the box beside Use Metric Units.
5. Click Save.
6. Select the desired option:
  - Get GPS Location (One-time satellite fix)
  - Start GPS Tracking (Continuous tracking)

The needle on the GPS icon (  ) flashes while the mobile hotspot is attempting to get a GPS fix.

If you have trouble obtaining a fix, ensure that the device has an unobstructed view of the sky and you are not near tall buildings or other barriers that could be blocking the GPS satellite signal.

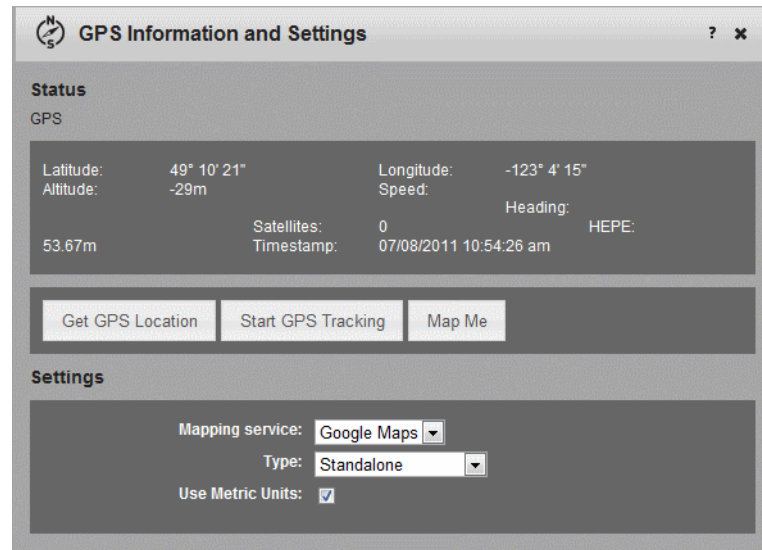

7. If desired, select a mapping service.
8. Optional: Click the Map Me button to view your location on a map and search for nearby amenities.

## Battery Settings

The mobile hotspot, by default, is configured to optimize battery life. Battery life is affected by:

- Standby time
- Data throughput
- GPS option (GPS tracking uses more power than getting a single GPS location fix.)
- Mobile Broadband signal strength (the better the signal, the longer the battery life)
- Wi-Fi range:
  - Short Wi-Fi range—Extend battery life
  - Medium Wi-Fi range—Intermediate battery life and Wi-Fi range
  - Long Wi-Fi range—Enables you to have your laptop (or other Wi-Fi device) further from your mobile hotspot and still connect to your Wi-Fi network, but battery life is shorter.

## Extend Battery Life

There are several methods you can use to extend the battery life.

If the computer and other devices you are connecting to your Wi-Fi network are always close to the mobile hotspot device, you can increase the battery life by shortening the Wi-Fi range.



1. Go to the Mobile Hotspot Homepage and log in as Administrator. (See [Homepage](#) on page 14.)

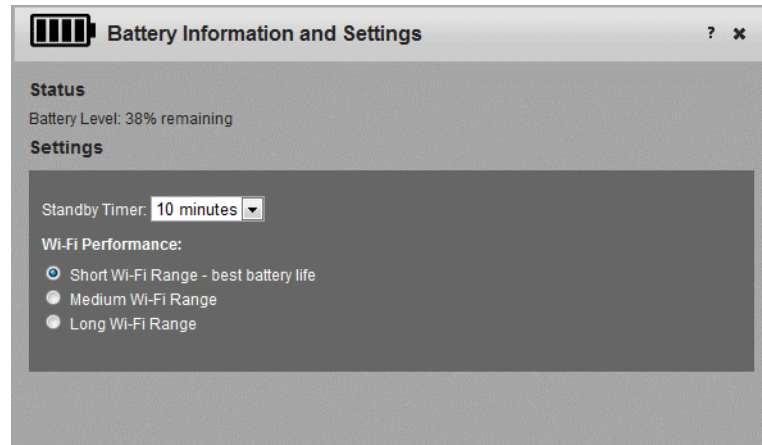

2. Click the Battery icon (  ) and select Short Wi-Fi range.
3. Click Save. (Save button appears once you make a selection.)

You can also extend the battery life by adjusting the Power LED and LCD backlight settings.

1. Go to the homepage and log in as Administrator.
2. Click the Advanced Settings icon (  ).
3. Select the Device tab and then select Display.

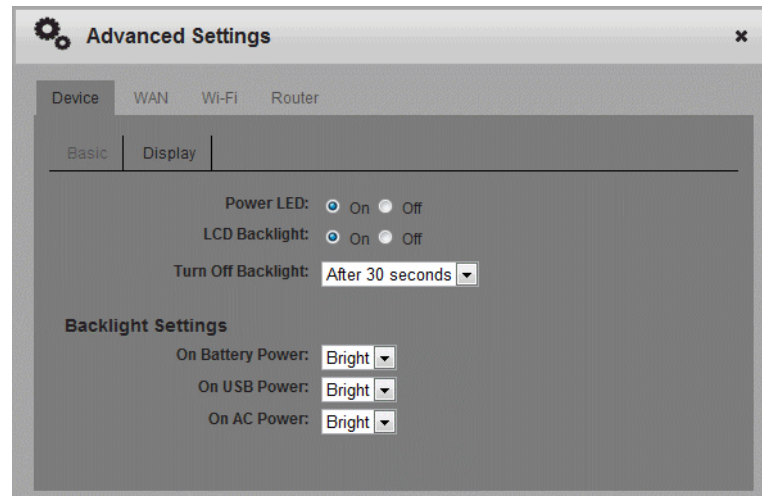

4. Set the desired options. For example, you can:
  - Turn the Power LED and LCD backlight off.
  - Set the time after which the LCD backlight turns off. (The shorter the time, the longer the battery life.)
  - Set the LCD backlight to DIM.
5. Click Save. (Save button appears once you make a selection.)

Another way to extend the battery life is to adjust the Standby Timer. The Standby Timer sets the length of time the mobile hotspot remains active when no devices are connected to the Wi-Fi network.

To set the Standby Timer:

1. On the homepage, log in as Administrator.
2. Click the Battery icon (🔋).
3. In the drop-down list beside Standby Timer on Battery, select the desired time. (The shorter the time, the longer the battery life.)
4. Click Save. (Save button appears once you make a selection.)

## Set Audio Alerts

You can configure your mobile hotspot to sound an alert when the status changes. For example:

- When the connection status changes
- When you receive an SMS message
- When the battery is low
- When the mobile hotspot enters standby mode

To turn off all audio alerts, set the mute switch on the mobile hotspot so that the red rectangle is visible.

To choose which changes in status are accompanied by an audio alert:

1. Set the mute switch so that the red rectangle is not visible.
2. On the Mobile Hotspot Homepage, click the Alert Sounds icon (🔊).

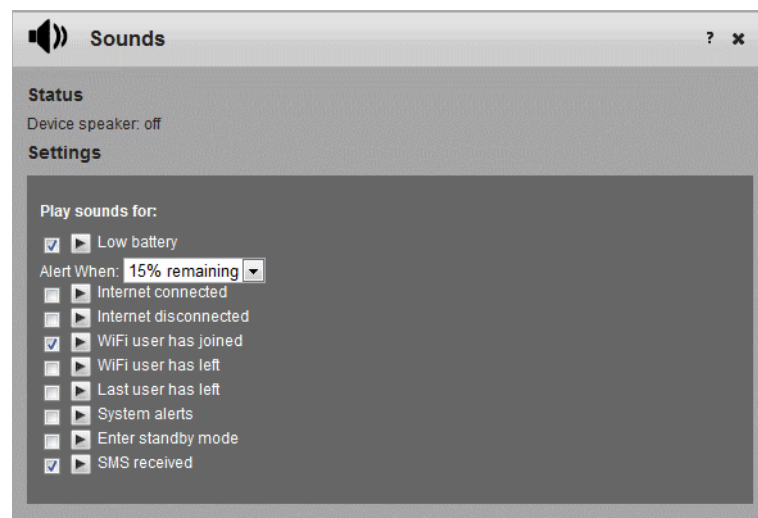

3. Select the desired options.
4. Click Save. (Save button appears once you make a selection.)

## Change Device Security Settings

To change security settings such as Admin Login, SSID, Wi-Fi encryption, and Wi-Fi Key:

1. On the Mobile Hotspot Homepage, click the Device Security icon (🔒).

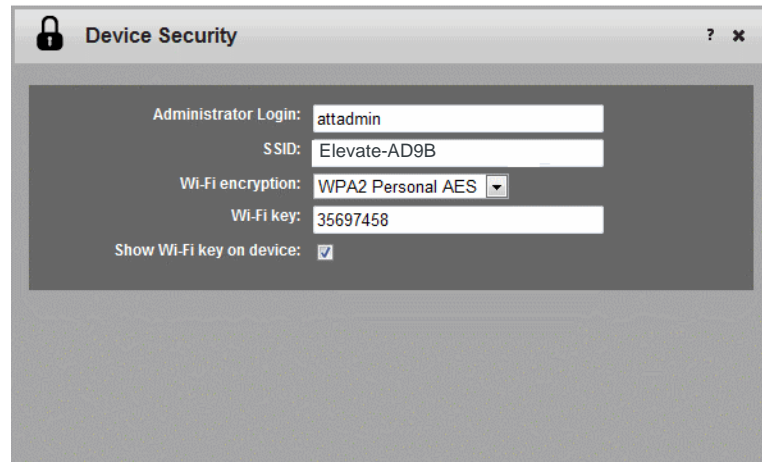

2. Change the desired options.

By default, the Wi-Fi Key is shown on the LCD screen. If you do not want it to appear on your LCD screen, deselect the box beside Show Wi-Fi Key on device.

The Wi-Fi encryption options are:

- WPA2 Personal/AES — Strong security supported by newer Wi-Fi devices (default)
- WPA/WPA2 Personal — Strong security supported by most Wi-Fi devices (Use this if you want to connect Wi-Fi devices that do not support WPA2 Personal /AES.)
- None — Not recommended. Anyone can access your Wi-Fi network without a password and you are responsible for charges incurred.

The encryption options available depend on the Wi-Fi rate. To change the Wi-Fi rate and select another encryption option, go to Advanced Settings > Wi-Fi > Security. For details, see [Set Wi-Fi Security Options](#) on page 41.

3. Click Save. (Save button appears once you make a selection.)
4. You may need to reconnect your Wi-Fi devices using the new Wi-Fi credentials. See [Set Up and Connect to the Internet](#) on page 13.

## View Details About Your Mobile Hotspot

To view details about your device such as the model number, software version, IMEI, etc., go to the Mobile Hotspot Homepage, and click the About Your Mobile Hotspot icon (i).

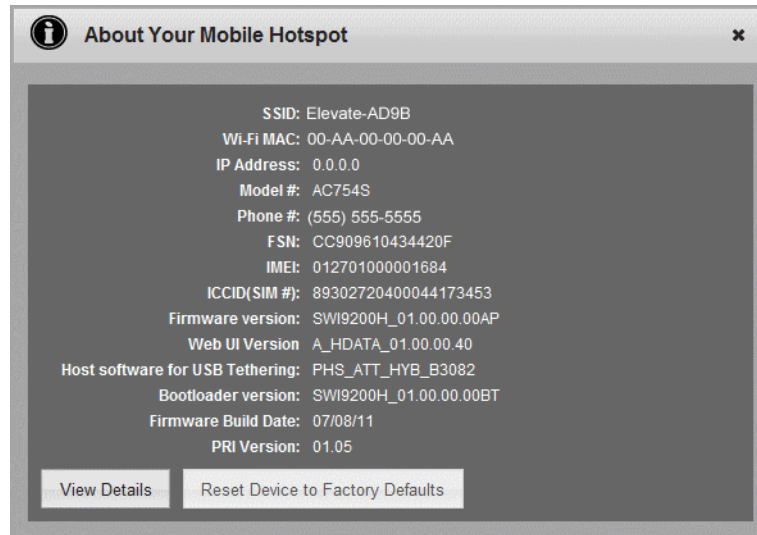

For additional information and to save a file you can forward to AT&T Customer Care, click View Details.

## Use the microSD Card

Your mobile hotspot is equipped with a microSD reader. You can use this feature in tethered mode to store information on the microSD card. The mobile hotspot supports microSD cards with up to 32 GB capacity.

To use the microSD card to store files:

1. Remove the back cover.

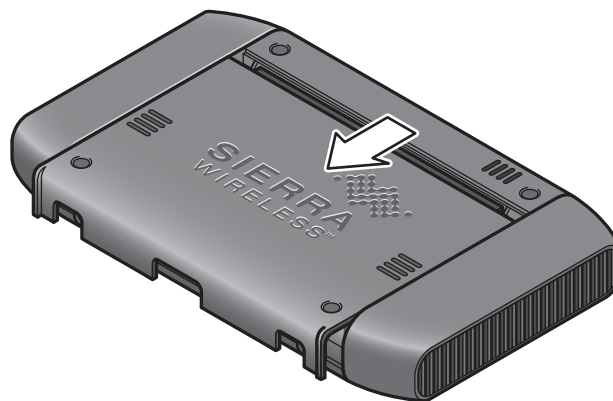

2. Insert the microSD card as shown in the illustration.

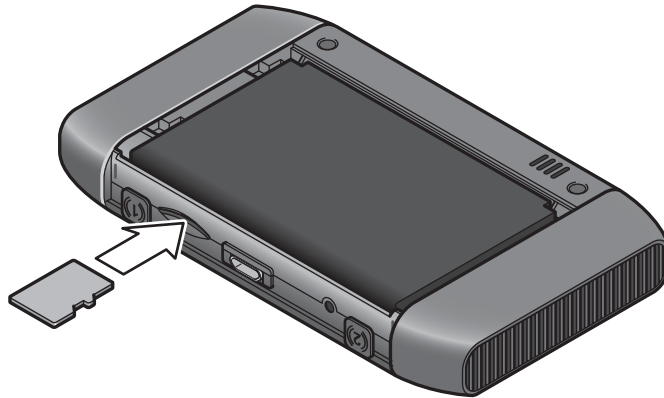

3. Replace the back cover.
4. Use the USB cable to connect the mobile hotspot to a USB port on your computer.
5. Go to the Mobile Hotspot Homepage and log in as Administrator. (See [Homepage](#) on page 14.)
6. Click the microSD icon (  ) for instructions on using the microSD feature.

 **SD Card Information** ✕

The AT&T Mobile Hotspot Elevate 4G supports microSD storage cards up to 32GB in storage. The microSD functionality allows users to copy and access files stored on your mobile hotspot when the device is tethered to a PC via the USB cable. To insert the microSD card, remove the battery cover on your mobile hotspot and insert the storage card as indicated in the image below:

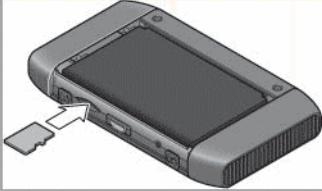

Replace the back cover and connect the USB cable to both your mobile hotspot and your PC. You can now access the card via your "Computer" section on a Windows computer or via the desktop on a Macintosh computer.

Note: first time tethering via USB may launch the driver installation utility. Install the drivers first to be able to access the microSD storage on your mobile hotspot.

## Recharge the Battery

The battery comes partially charged. You can recharge the battery from a wall socket or from the USB port on your computer.

To recharge the battery from a wall socket (Fastest option):

1. Attach one end of the micro USB cable to the mobile hotspot and attach the other end to the AC adapter (included).

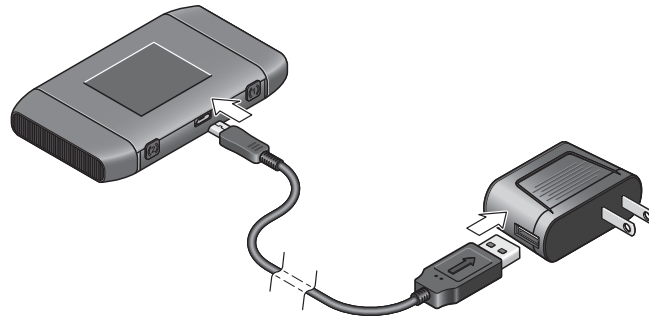

2. Plug the AC adapter into a wall socket. An animated battery icon on the LCD screen indicates that the battery is charging.

The battery icon on the LCD screen indicates when the battery is fully charged.



---

*Note: The LCD goes into sleep mode after a set time to extend battery life. To wake up the LCD screen, press and quickly release the power button.*

---

To recharge the battery from the USB port on your computer:

1. Attach one end of the micro USB cable to the mobile hotspot and plug the other end into the USB port on your computer. An animated battery icon indicates that the battery is charging.

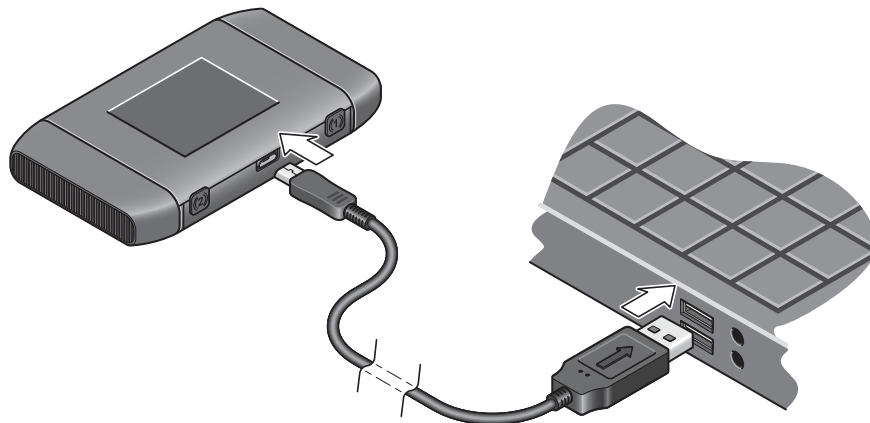

The battery icon on the LCD screen indicates when the battery is fully charged.



## Replace the SIM Card

Your mobile hotspot comes with the SIM card inserted. If you need to replace the SIM card:

1. Remove the back cover.

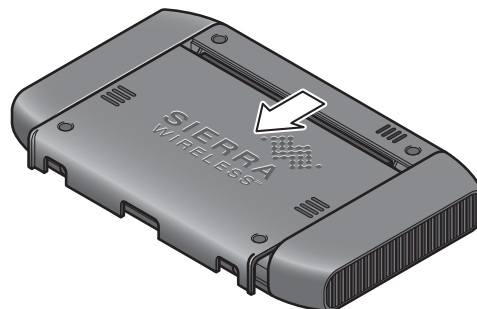

2. Slide the SIM card cover to the Open position.

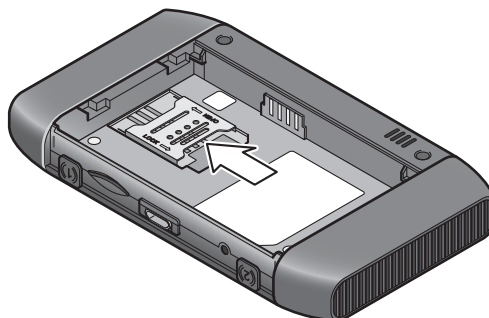

3. Lift the SIM card cover, remove the existing SIM card and replace it with the new one.

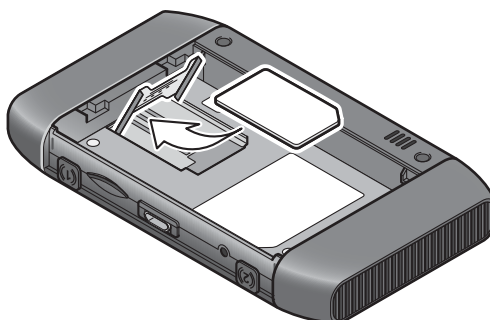

4. Lower the SIM card cover.

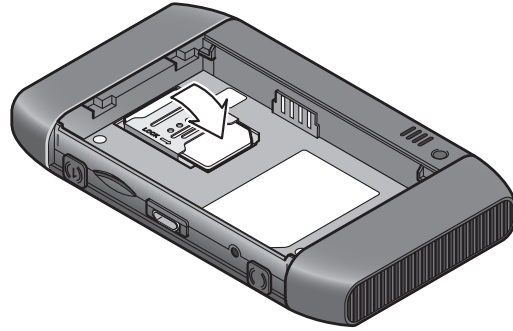

5. Slide the SIM card cover to the Lock position.

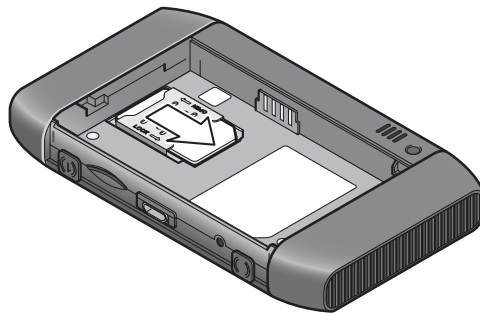



## 3: Advanced Settings

This chapter provides information on how to change advanced settings. The advanced settings enable you to configure various aspects of the device such as Wi-Fi settings, WAN settings, router settings, etc.

### Do not Automatically Install Driver for USB Tethering

By default, a host driver is installed the first time you connect your mobile hotspot to the computer via the USB cable. This driver enables the mobile hotspot to connect to the Internet when it is tethered to a USB port on the computer via the USB cable instead of using the Wi-Fi network.

If you do not want to use this feature and want to use USB cable only to charge the mobile hotspot battery, you can set the host driver not to install.

To set the host driver not to install:

1. On the Mobile Hotspot Homepage, click the Advanced Settings icon (⚙️).

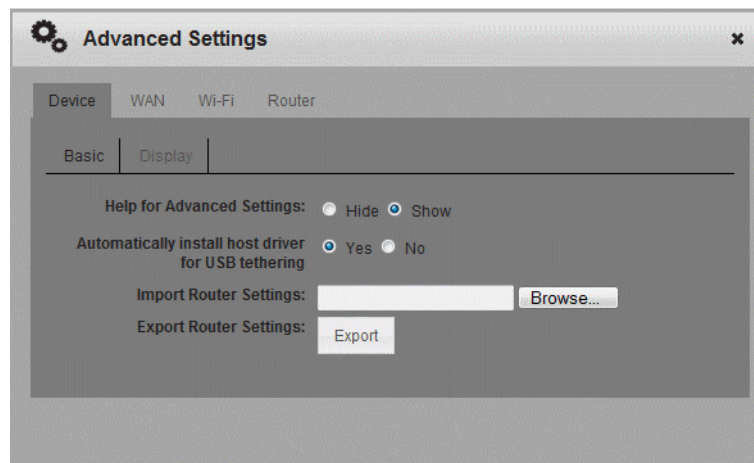

2. On the Device > Basic tab, beside Automatically install host driver for USB tethering, select No.
3. Click Save.

### Export / Import Router Options

You can export and import hotspot (router) settings. This is useful if you have more than one device and you want the same settings on both, or to save your settings before doing a factory reset or changing the settings.

To export router settings:

1. On the Device > Basic tab, beside Export Router Settings, click Export.

2. Click Save. (Save button appears once you make a selection.)

To import router settings:

1. On the Mobile Hotspot Homepage, click the Advanced Settings icon (⚙️).

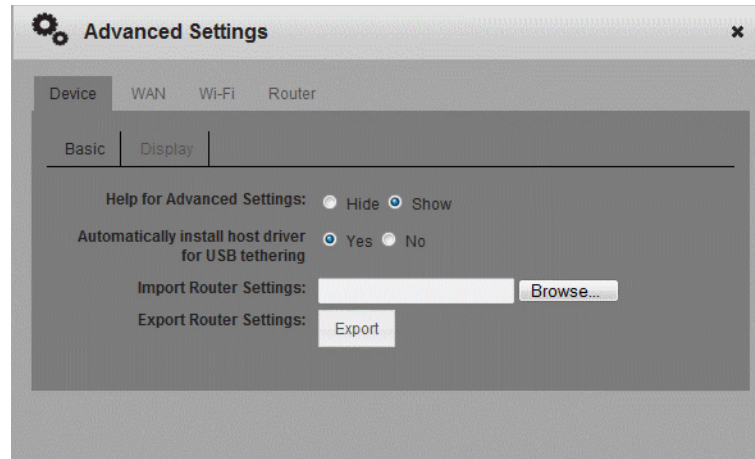

2. On the Device > Basic tab, beside Import Router Settings, type the path or use the Browse button to navigate to the file you want to import.
3. Click Open, and then click OK to confirm restart.

## Set Display Options

You can use the display options to customize the mobile hotspot display and to conserve battery power.

To set the display options:

1. On the Mobile Hotspot Homepage, click the Advanced Settings icon (⚙️).
2. On the Device > Display tab, select the desired options:
  - Power LED  
The Power LED blinks to confirm that the mobile hotspot is powered on. Turning it off can extend battery life.
  - LCD Backlight  
You can control how long the LCD backlight is on before going into sleep mode. You can set the LCD backlight to turn off after 10, 30 or 60 seconds, or to never turn off. (Default is 60 seconds.) To wake up the LCD, press and release the power button.
  - Backlight brightness settings  
You can control the brightness of the backlight settings when the mobile hotspot is powered by battery, USB port, or AC power. The options are off, dim, or bright.

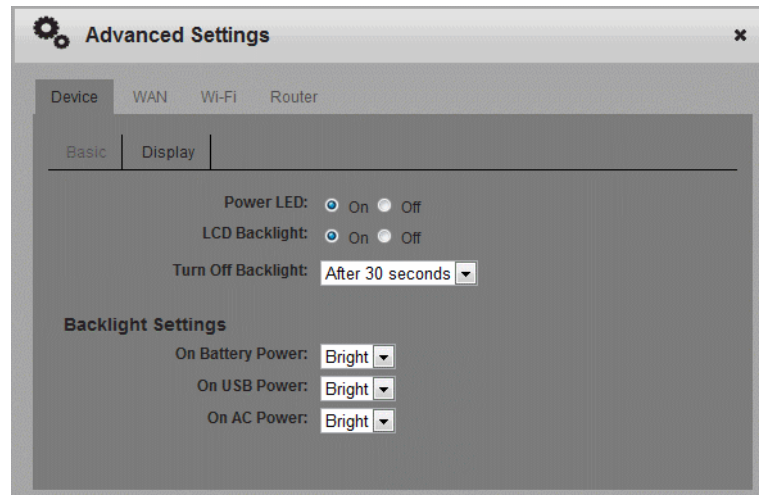

3. Click Save. (Save button appears once you make a selection.)

## Set Audio Alerts

You can configure the mobile hotspot to beep when specific changes occur to its status.

To set the audio alerts:

1. On the device, set the mute switch so that the red rectangle is not visible.
2. On the Mobile Hotspot Homepage, click the Alert Sounds icon (⚙️).
3. Select the status changes for which you want to hear a beep.  
If you want to hear a beep when the battery is low, choose the battery level at which you would like to be warned.

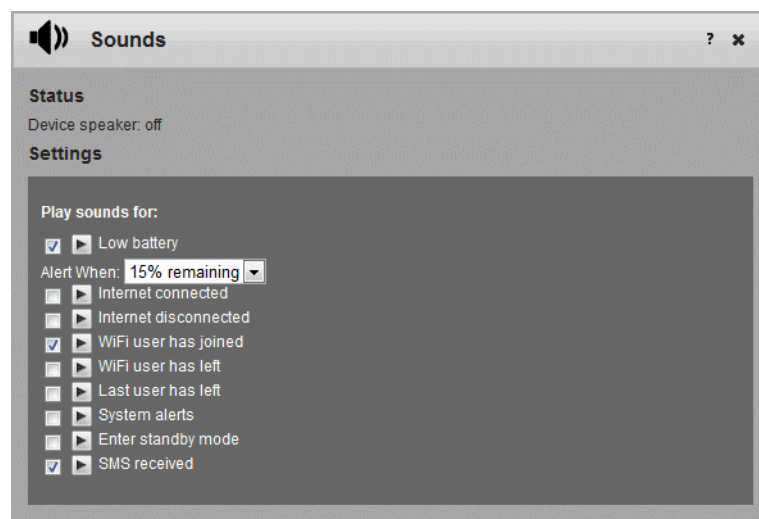

4. Click Save. (Save button appears once you make a selection.)

## View and Save Device Information

You can view and save a file with detailed information about your mobile hotspot. If AT&T Customer Care is troubleshooting an issue, they may ask you to save this information and send it to them.

To view and save detailed information about your mobile hotspot:

1. On the Mobile Hotspot Homepage, click the About Your Mobile Hotspot icon (i).

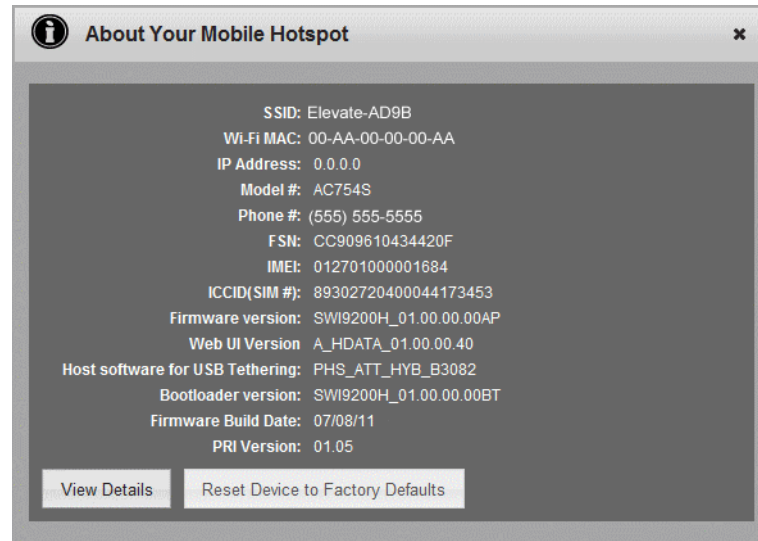

2. Click View Details.

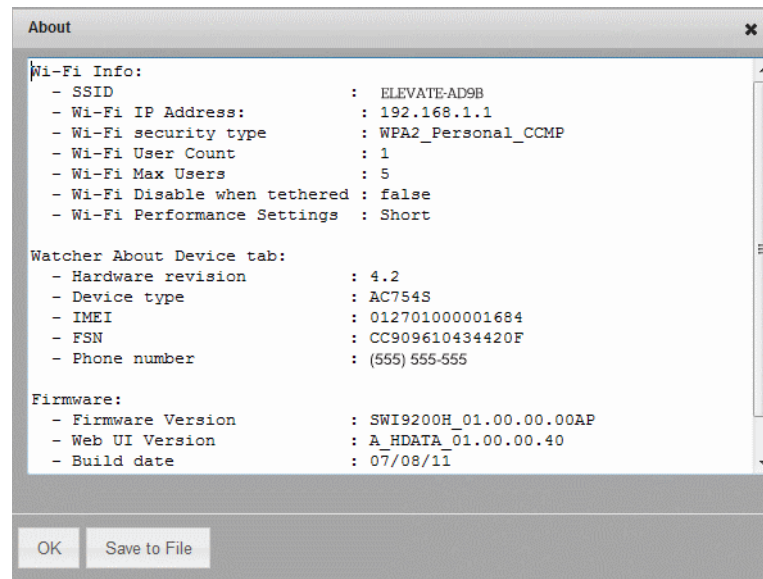

3. Click Save to File and follow the on-screen instructions to save the file. To close the window, click OK.

## View WAN Information

To view network information, such as the active network, connection status, signal strength, etc.:

1. On the Mobile Hotspot Homepage, click the Advanced Settings icon (⚙️).
2. Click the WAN tab.

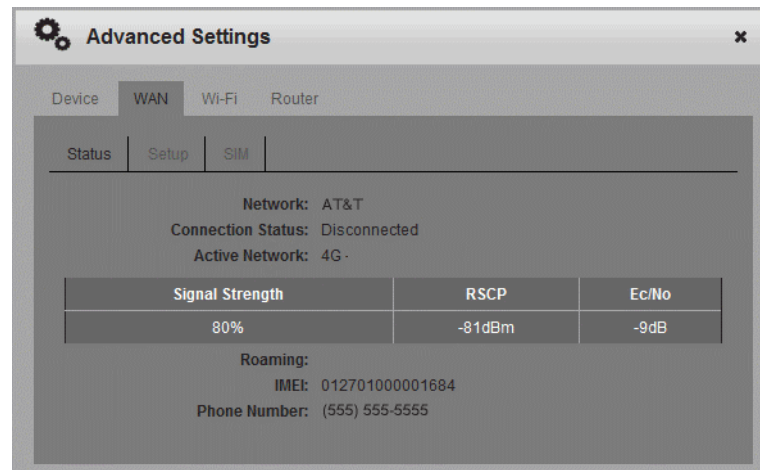

## Set Connection Preferences

To set the connection preferences:

1. On the Mobile Hotspot Homepage, click the Advanced Settings icon (⚙️).
2. Go to WAN > Setup.

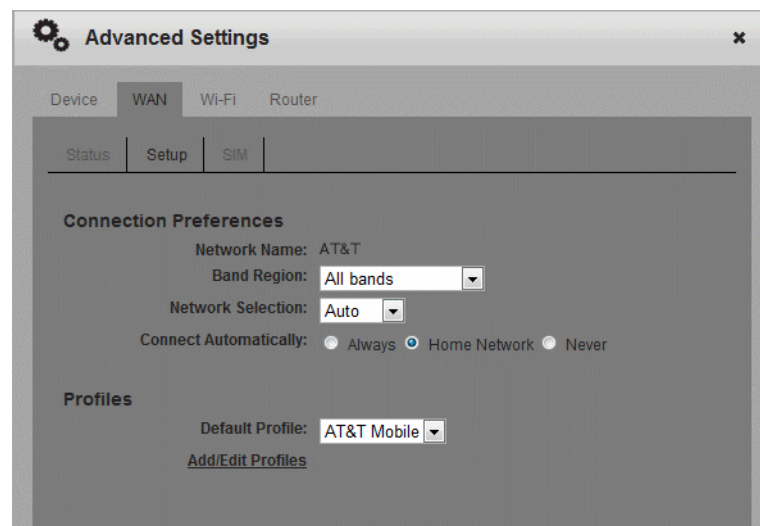

3. Select the desired options.  
You can use the manual network selection mode to select a mobile network when roaming internationally. When a network is manually selected, the

device does not automatically connect to AT&T's mobile network when you re-enter AT&T's coverage area. In this case, go to the Mobile Hotspot Homepage and reset this option to use AT&T's mobile network.

We recommend that you leave it set to "Auto".

4. Click Save. (Save button appears once you make a selection.)

## Enable SIM Security

If desired, you can create another level of security by setting up a PIN number that must be entered before you can view the information available to an administrator or change the mobile hotspot settings on the homepage.

If you set up a PIN number, when you go to the homepage and log in as administrator, you will be asked to enter the PIN number before you can access the homepage as an administrator.

To enable SIM security:

1. On the Mobile Hotspot Homepage, click the Advanced Settings icon (⚙️).
2. Go to WAN > SIM.

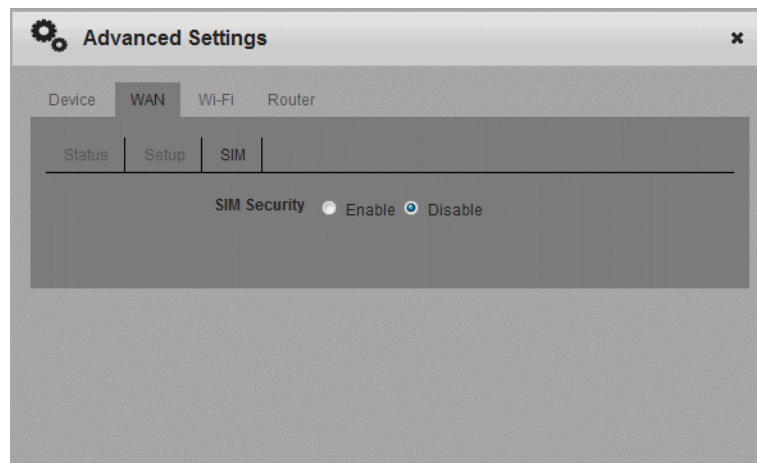

3. Select Enable and click Save. (Save button appears once you make a selection.)

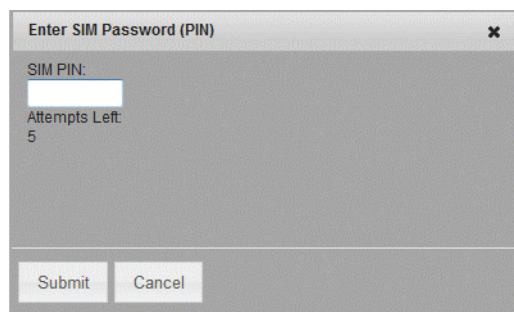

4. Enter your PIN and click Submit.

You are allowed 5 attempts to enter the correct PIN. If you run out of available attempts the PIN will be locked. If this happens, contact AT&T Customer Care to receive a PUK number to unlock the PIN.

## View Wi-Fi Status and List of Connected Devices

To view Wi-Fi status and a list of connected devices:

1. On the Mobile Hotspot Homepage, click the Advanced Settings icon (⚙️).
2. Go to Wi-Fi > Status.

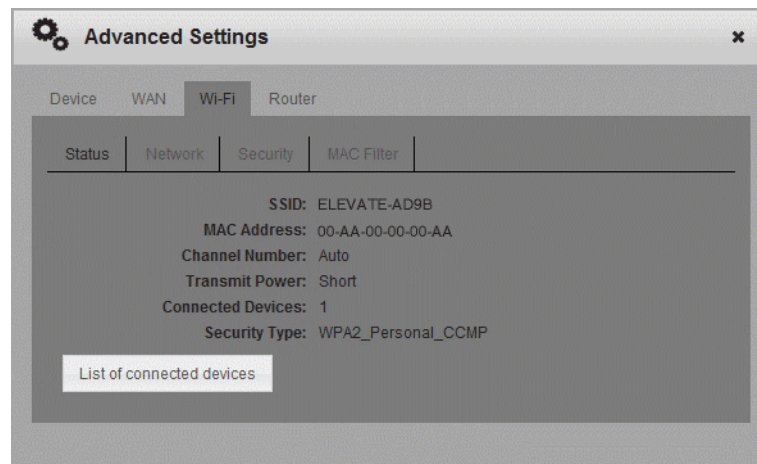

3. If desired, click the link to view a list of connected devices.

## Set Wi-Fi Network Options

To set the Wi-Fi network options:

1. On the Mobile Hotspot Homepage, click the Advanced Settings icon (⚙️).
2. Go to Wi-Fi > Network.

The screenshot shows a window titled "Advanced Settings" with a close button (X) in the top right corner. Below the title bar are four tabs: "Device", "WAN", "Wi-Fi", and "Router". The "Wi-Fi" tab is selected. Underneath, there are four sub-tabs: "Status", "Network", "Security", and "MAC Filter". The "Network" sub-tab is active. The configuration options are as follows:

- Enable Wi-Fi:  On  Off
- SSID:
- Hostname:  http://att.elevate
- SSID Broadcast:  Enable  Disable
- Max Wi-Fi users: 5
- Wi-Fi Performance:  Short Range  Medium Range  Long Range
- Wi-Fi Channel:  (dropdown menu)
- Basic Rate: [To change go to security](#)
- RTS Threshold:
- Fragmentation Threshold:

3. Select the desired options.

SSID Broadcast — If you select Enable, your SSID (network name) will be broadcast to everyone nearby. (Select Disable if you do not want it broadcast.)

RTS Threshold — The smallest packet size (in bytes) used by the Request to Send/Clear to Send handshaking protocol. The recommended value is 2347. If you are experiencing inconsistent data flow, you can make minor changes to this value to try to alleviate the problem.

Threshold fragmentation — The largest allowable size (in bytes) for a packet. If the packet is larger than this, it is sent in multiple packets, which can affect network performance. It is recommended to keep this value as large as possible (up to 2346).

4. Click Save. (Save button appears once you make a selection.)



## Set Wi-Fi Security Options

To set the Wi-Fi security options:

1. On the Mobile Hotspot Homepage, click the Advanced Settings icon (⚙️).
2. Go to Wi-Fi > Security.

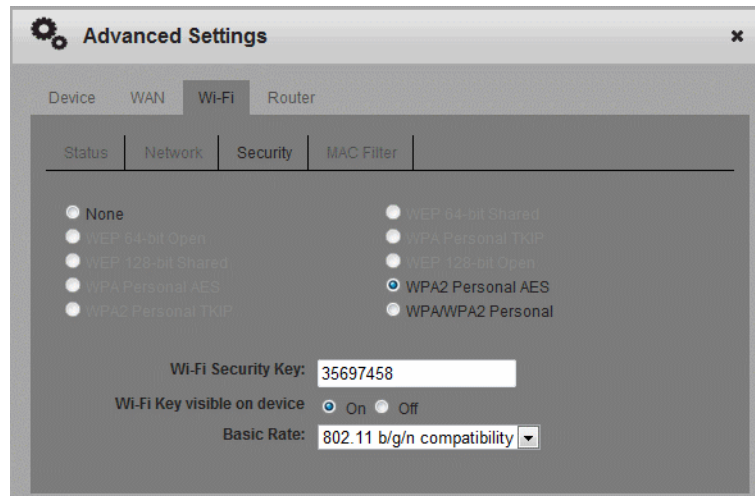

3. Select the desired options and click Save.

The options available depend on the Wi-Fi rate. If you want to choose a Wi-Fi encryption other than WPA2 Personal / AES or WPA / WPA2 Personal:

1. Change the basic rate to 802.11b/g compatibility.
2. Select the desired encryption options.

It is recommended that you use WPA2 Personal /AES whenever possible.

---

*Note: The length of the Wi-Fi Key depends on the Wi-Fi encryption selected. Mouse-over the field for details.*

---

## Set MAC Filter Mode

MAC (Media Access Control) filtering enables you to block unauthorized Wi-Fi devices from accessing your Wi-Fi network, based on each device's MAC address.

To enable MAC filter mode:

1. On the Mobile Hotspot Homepage, click the Advanced Settings icon (⚙️).
2. Go to Wi-Fi > MAC Filter.

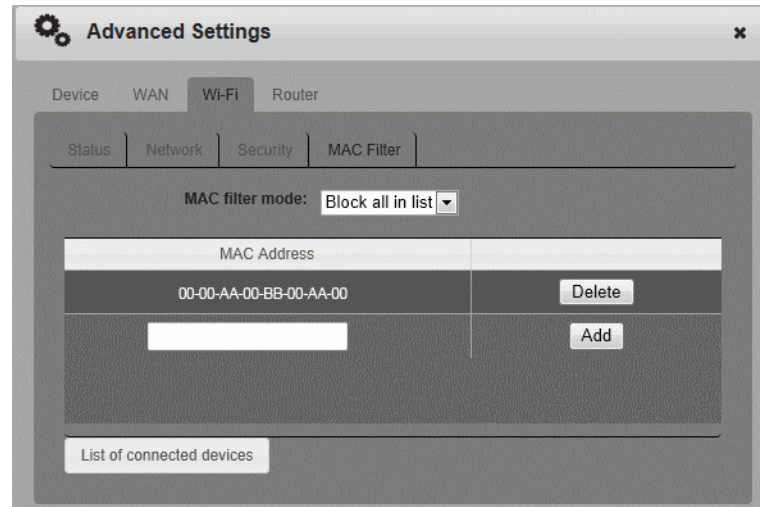

To block a user (device), enter the MAC address of the device you want to block and click Add, or click List of connected devices and select the box in the Block column beside the device you want to block. Reconnect your Wi-Fi devices.

To unblock a user (device), click Delete beside the MAC address of the blocked device and then click Save. Reconnect your Wi-Fi devices.

## Enable Port Forwarding

If your computer is hosting a server, you can enable port forwarding so that other users can access the server.

To enable port forwarding:

1. On the Mobile Hotspot Homepage, click the Advanced Settings icon (⚙️).
2. Go to Router > Basic.

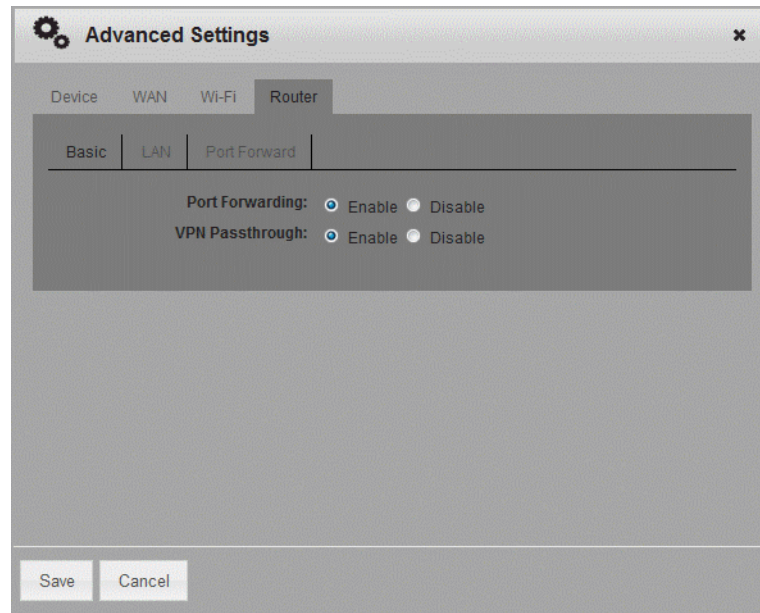

3. Select Enabled beside Port Forwarding and click Save.

Incoming traffic is forwarded to specific ports and devices on your network (using their local IP addresses).

Note: Port forwarding creates a security risk. When not required, port forwarding should be disabled.

4. Go to Router > Port Forwarding.

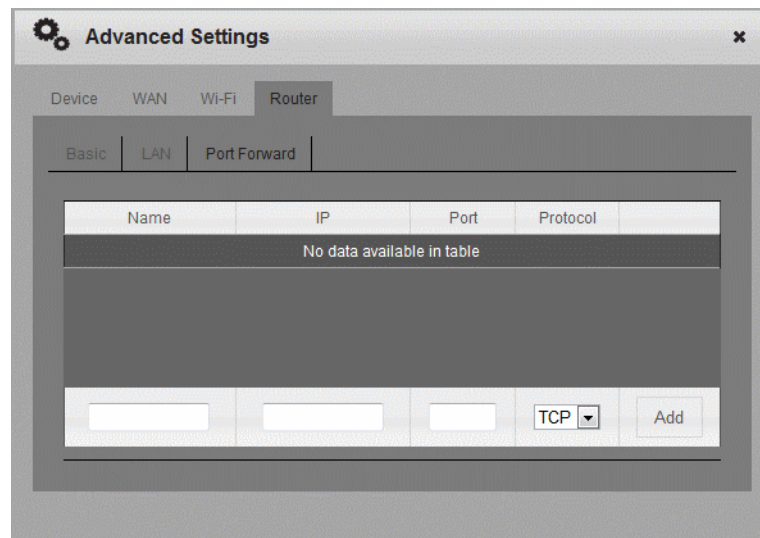

5. Enter the Port Forwarding information and click Save. (Save button appears once you make a selection.)

## Enable VPN Passthrough

If you want to connect to a corporate network using VPN, you first need to enable VPN connections (passthrough).

To enable VPN passthrough:

1. On the Mobile Hotspot Homepage, click the Advanced Settings icon (⚙️).
2. Go to Router > Basic.

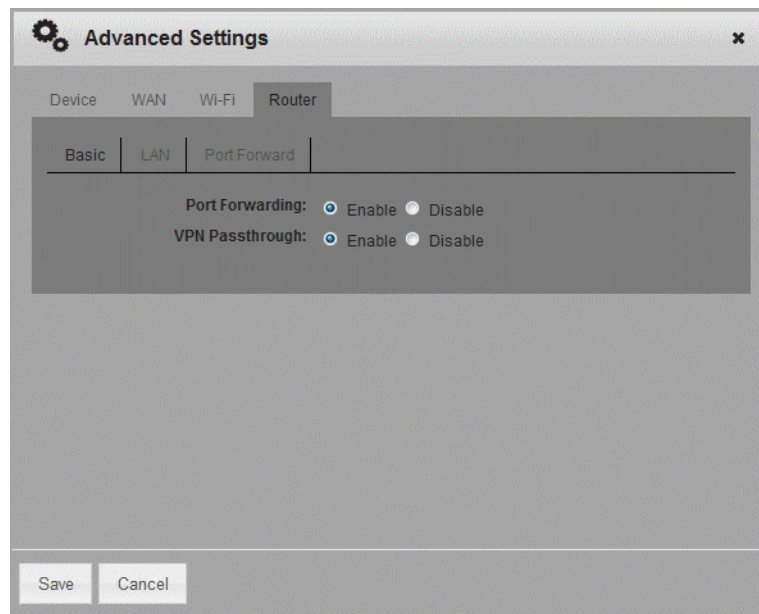

3. Select Enabled beside VPN passthrough, and click Save.

## Set Router LAN Options

To set the router LAN options:

1. On the Mobile Hotspot Homepage, click the Advanced Settings icon (⚙️).
2. Go to Router > LAN.

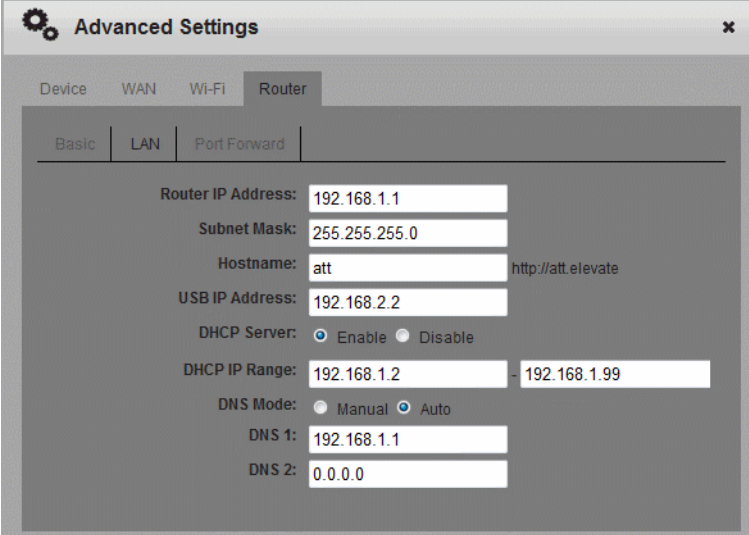

The screenshot shows the 'Advanced Settings' window with the 'Router' tab selected. The 'Basic' sub-tab is active, displaying the following configuration fields:

- Router IP Address: 192.168.1.1
- Subnet Mask: 255.255.255.0
- Hostname: att (with a URL preview: http://att.elevate)
- USB IP Address: 192.168.2.2
- DHCP Server:  Enable  Disable
- DHCP IP Range: 192.168.1.2 to 192.168.1.99
- DNS Mode:  Manual  Auto
- DNS 1: 192.168.1.1
- DNS 2: 0.0.0.0

3. Enter the desired information.  
If the DHCP Server is enabled, it automatically assigns an IP address to each device on the network and manages their configuration information.  
The DNS mode setting specifies how the DNS servers are obtained. If you select Auto, the servers use the DNS relay specified by the Internet provider.
4. Click Save. (Save button appears once you make a selection.)

## 4: Frequently Asked Questions

This chapter provides answers to questions you may have about your mobile hotspot. (Also see [Troubleshooting](#) on page 49.)

### What do I do if I forget my Wi-Fi Key or Admin Login?

The Wi-Fi Key appears on the LCD, unless you have configured it not to show.

The default Admin Login (**attadmin**) is printed on a label under the battery.

If you have changed either of these and then forgotten them:

1. Reset the device to the factory settings. (See [Reset the Mobile Hotspot](#) on page 51.)
2. Use the default Wi-Fi Key and Admin Login (**attadmin**) to connect to the Wi-Fi network and log in as Administrator. See [Set Up and Connect to the Internet](#) on page 13.

### How do I disconnect from the mobile broadband network?

Do one of the following:

- On the Mobile Hotspot Homepage, click Disconnect (below the virtual mobile hotspot).
- Press and hold the power button for a few seconds to turn off the mobile hotspot.

### I can't see the Connect / Disconnect button on the homepage.

The Connect / Disconnect button is only visible when you are logged in as Administrator.

To log in as Administrator:

1. Place your cursor in the Admin Login box on the homepage and type the Admin Login (**attadmin**).
2. Click Login.



## How can I extend the life of the battery?

For information on extending the life of the battery, see [Extend Battery Life](#) on page 24.

## How do I turn the mobile hotspot off?

Press and hold the power button for a few seconds, or click the Power off button on the homepage.

## How do I find out how many users are connected to my mobile hotspot network?

The number beside the Wi-Fi icon () on the mobile hotspot LCD shows the number of users (or devices) connected to your Wi-Fi network. For more details about the devices or users connected to your network, go to the Mobile Hotspot Homepage, log in as Administrator, and click the Wi-Fi icon ().

---

*Note: You can also use the options on the homepage to block particular users from connecting to your network. See [View / Block Connected Users](#) on page 19.*

---

## The LCD screen is not lit. How do I know if the mobile hotspot is still powered on?

The LCD screen dims to save energy. The blue LED continues to flash (provided you have not turned this feature off) to indicate that the mobile hotspot is still powered on. To wake up the LCD, press and quickly release the power button.

## How do I access information on the microSD card?

1. Insert the microSD card. (See [Use the microSD Card](#) on page 28.)
2. Use the USB cable to connect the mobile hotspot to a USB port on your computer.

You can access the files on the microSD card through Computer / My Computer (Windows) or the Desktop (Mac).

## Where can I find more information?

- View the Online Help:
  1. Go to the Mobile Hotspot Homepage. (See [Homepage](#) on page 14.)
  2. Click the Help icon ().
- For more information about using your new device, visit the interactive web tutorial available at [att.com/Tutorials](http://att.com/Tutorials).
- Additional support is available online including device specifications, troubleshooting and user forums at [att.com/DeviceSupport](http://att.com/DeviceSupport).

- Go to [www.sierrawireless.com/support](http://www.sierrawireless.com/support) and select AT&T and Mobile Hotspot Elevate 4G.  
From the Sierra Wireless Web site, you can:
  - Update the firmware on your device
  - View tutorials
- Refer to the Quick Start Guide that came with your mobile hotspot.





## 5: Troubleshooting

This chapter provides suggestions for troubleshooting problems that may arise when using your mobile hotspot.

### The mobile hotspot network name does not appear in the list of networks.

Refresh the list of networks.

1. Ensure that the Wi-Fi setting on your laptop (or other device) is turned on.
2. Ensure that Wi-Fi is enabled on the mobile hotspot. The Wi-Fi icon on the LCD should have a "0" beside it  (not an "x" ).

If you need to enable Wi-Fi on the mobile hotspot:

1. Use the USB cable to tether the mobile hotspot to your laptop. (The first time you do this, it will take a few moments for the drivers to install.)
2. Launch your browser and go to the Mobile Hotspot Homepage.
3. Click the Wi-Fi users icon (  ).
4. Under Enable Wi-Fi, select On.
5. Click Save.

### The No Signal icon appears on the LCD screen.

If the No Signal icon (  ) appears on the LCD screen, make sure you are in the AT&T coverage area.

### The Wi-Fi radio is disabled icon appears on the LCD screen.

If the Wi-Fi radio is disabled icon (  ) appears on the LCD screen:

1. Use the USB cable to tether the mobile hotspot to your laptop.
2. Launch your browser and go to the Mobile Hotspot Homepage.
3. Click the Wi-Fi users icon (  ).
4. Under Enable Wi-Fi, select On.
5. Click Save.

## Unable to access the homepage when connected to a VPN

If you are using your mobile hotspot while connected to a VPN, you may not be able to access the mobile hotspot using <http://att.elevate>.

To access the homepage, enter the address <http://192.168.1.1> in your browser. This directly accesses the homepage hosted on the device.

## Unable to connect a computer running Windows<sup>®</sup> Vista<sup>®</sup> to the mobile hotspot

Microsoft has a known issue whereby computers running Windows Vista cannot obtain an IP address from certain routers. More information and a fix are available at <http://support.microsoft.com/kb/928233> or go to the Microsoft support web site and search for knowledge base article 928233.

## My computer (or other Wi-Fi device) loses its Wi-Fi connection to the mobile hotspot.

If a Wi-Fi device connects to your mobile hotspot Wi-Fi network, but periodically loses the connection, try changing the default basic rate.

1. On the main Web UI window, click the Advanced Settings icon (⚙️).
2. Go to Wi-Fi > Security.
3. In the Basic Rate field, select 802.11b/g compatibility from the drop-down menu.

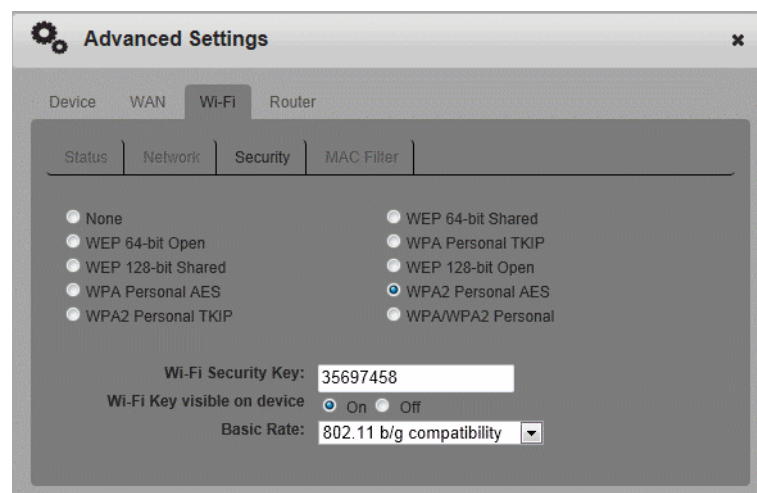

4. Click Save.

## Reset the Mobile Hotspot

You can reset the Mobile hotspot to the factory setting on the device or on the Mobile Hotspot Homepage. This is useful if you have lost your Wi-Fi Key.

### To reset the mobile hotspot on the device:

1. Remove the back cover.

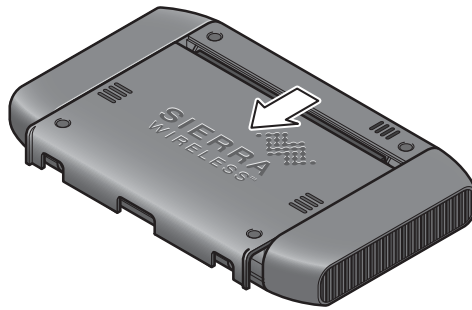

2. Use a small object such as the end of a paper clip to press and hold the reset button for 5 to 10 seconds.

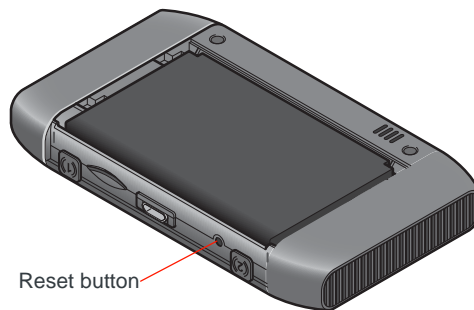

3. When prompted on the LCD to do so, press the power button to confirm the reset.
4. Replace the back cover.

### To reset the mobile hotspot on the Mobile Hotspot Homepage:

1. On the Mobile Hotspot Homepage, click the About Your Mobile Hotspot icon (i).
2. Click Reset Device to Factory Defaults.

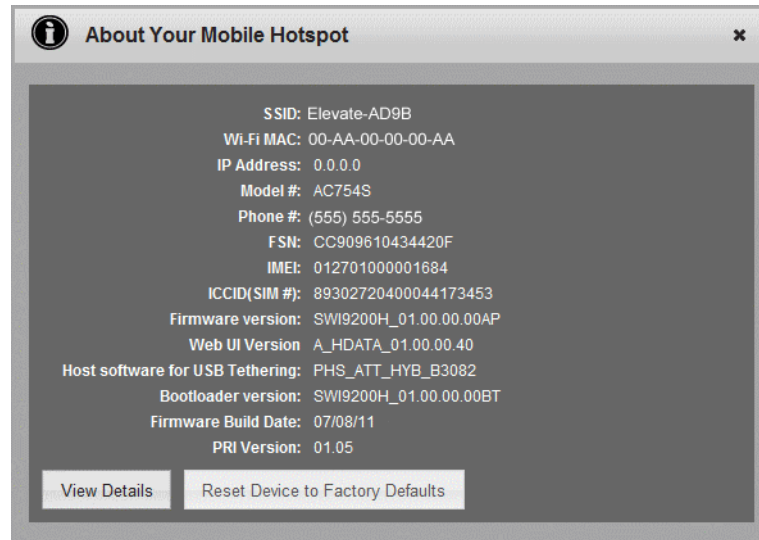

3. Click Save.

## Alerts

### SIM not installed

Ensure that the SIM card is installed correctly. See [Replace the SIM Card](#) on page 31.

### SIM Error — Check SIM

Ensure that you have an AT&T SIM card inserted in the mobile hotspot. If there is still a problem, contact AT&T Customer Care. (The SIM may be damaged and need replacing.)

### SIM Locked

1. Contact AT&T Customer Care for the PIN to unlock the SIM.
2. Go to the Mobile Hotspot Homepage. (See [Homepage](#) on page 14.)
3. Log in as Administrator. (See [Security Credentials](#) on page 16.)
4. Enter the SIM PIN when prompted.
5. Click Save.

### SIM MEP Locked

1. Contact AT&T Customer Care for the MEP unlock codes and tool to unlock your Mobile Wi-Fi.

## Temperature-related alerts

The mobile hotspot is designed to work over a wide temperature range. (See [Environmental Specifications](#) on page 56 for details.) If you are outside that temperature range, the mobile hotspot issues an alert.

Move the device to an area where the temperature is more suitable and, if the mobile hotspot is too warm, make sure the area is well-ventilated and air can circulate around the device.

---

*Note: The battery may not recharge if the mobile hotspot is outside the operating temperature range.*

---

## WPS Setup Failed; Device not connected!

The device you are trying to connect may not be WPS-enabled. Use the manual method to connect the Wi-Fi device to your Wi-Fi network.

1. Open the Wi-Fi menu on the device you are trying to connect to the Wi-Fi network.
2. Select your Network Name from the list of available Wi-Fi networks.
3. Select Connect and when prompted, enter your Wi-Fi Key.

## Connection Alerts

If you receive any of the following connection alerts, contact AT&T Customer Care and provide them with the name and number of the alert.

**Table 5-1: Connection alerts**

Alert	Description
8	Operator Determined Barring
25	LLC or SNDCP failure
26	Insufficient resources
27	Missing or unknown APN
28	Unknown PDP address or type
29	User authentication failed
30	Activation rejected by GGSN
32	Service Option not supported
33	Service Option not subscribed
34	Service Option temporarily out of order
36	Regular deactivation
37	QOS not accepted
38	Network failure

**Table 5-1: Connection alerts**

<b>Alert</b>	<b>Description</b>
39	Reactivation required
40	Feature not supported
41	Semantic error in the TFT operation
42	Syntactical error in the TFT operation
43	Unknown PDP context
44	PDP context without TFT already activated
45	Semantic errors in packet filter(s)
46	Syntactical errors in packet filter(s)
67	Connection error
81	Invalid transaction identifier value
95	Semantically incorrect message
96	Invalid mandatory information
97	Message type non-existent or not implemented
98	Message type not compatible with the protocol state
99	Information element non-existent or not implemented
100	Conditional IE error
101	Message not compatible with the protocol state
111	Protocol error, unspecified
256	Invalid Connection ID
257	Invalid NSAPI
258	Invalid PRI NSAPI
259	Invalid Field
260	SNDCP Failure
261	RAB Setup Failure
262	No GPRS Context
263	PDP Establish Max Timeout
264	PDP Activate Max Timeout
265	PDP Modify Max Timeout
266	PDP Inactivate Max Timeout
267	PDP Lower layer Error

**Table 5-1: Connection alerts**

Alert	Description
268	PDP Duplicate
269	UE RAT Change

## 6: Specifications

### Mechanical Specifications

Weight	100g (3.53 oz.)
Length	96 mm (3.78 in.)
Width	57 mm (2.24 in.)
Thickness	16.5 mm (0.65 in.)

### Environmental Specifications

Operating temperature	0° C to 35° C (32° F to 95° F)
Storage temperature	-10° C to +65° C, 96 hours (14° F to 149° F)



## 7: Regulatory and Safety Information

### Notice

Because of the nature of wireless communications, transmission and reception of data can never be guaranteed. Data may be delayed, corrupted (that is, have errors), or be totally lost. Although significant delays or losses of data are rare when wireless devices such as the AT&T Mobile Hotspot Elevate 4G are used in a normal manner with a well-constructed network, the AT&T Mobile Hotspot Elevate 4G should not be used in situations where failure to transmit or receive data could result in damage of any kind to the user or any other party, including but not limited to personal injury, death, or loss of property. Sierra Wireless and its affiliates accept no responsibility for damages of any kind resulting from delays or errors in data transmitted or received using the AT&T Mobile Hotspot Elevate 4G, or for failure of the AT&T Mobile Hotspot Elevate 4G to transmit or receive such data.

### Safety and Hazards

The mobile hotspot **MUST BE POWERED OFF** in all areas that may be susceptible to radio interference, in particular:

- Prohibited areas  
Obey all signs and notices and follow all rules and regulations. Power off the mobile hotspot when instructed to do so or when you suspect that it may cause interference or danger.
- In areas where blasting is in progress
- Where explosive atmospheres may be present  
Areas with a potentially explosive atmosphere are not always clearly marked. Such areas include gas stations, fuel depots, chemical transfer or storage facilities, areas where blasting is in progress, areas where the air contains chemicals or particles such as grain, dust, or metal powders, and any other area where you would normally be advised to turn off your cellular phone or vehicle engine.
- Near medical or life-support equipment  
Medical equipment may be susceptible to any form of radio interference. In such areas the mobile hotspot can transmit signals that could interfere with this equipment.
- On board aircraft  
In addition to Federal Aviation Authority (FAA) requirements, many airline regulations state that you must suspend wireless operations before boarding an aircraft. The mobile hotspot is capable of transmitting signals that could interfere with various onboard systems and controls.  
Failure to observe this instruction may lead to suspension or denial of cellular telephone services to the offender, legal action, or both.  
Some airlines may permit the use of cellular phones while the aircraft is on the ground and the door is open. The mobile hotspot may be used normally at this time.

- While operating a vehicle  
The driver or operator of any vehicle should not use a wireless data device while in control of a vehicle. Doing so detracts from the driver or operator's ability to control and operate the vehicle. In some countries, using such communications devices while in control of a vehicle is an offence.

## Proper Battery Use and Disposal

---

*Note: Improper battery use may result in a fire, explosion, or other hazard.*

---

To ensure safe and responsible battery use:

- Do not open, disassemble, puncture, crush, bend, or shred.
- Do not expose to water or other liquids, fire, explosion, or other hazards.
- Use the battery only in the mobile hotspot.
- If using with a charger, use only the charger supplied with the mobile hotspot.
- Do not short circuit the battery.
- When replacing a battery, use the same model of battery that was supplied with the mobile hotspot.
- Follow local regulations when disposing of a used battery.
- Avoid dropping the mobile hotspot or the battery. If dropped and you suspect damage, take it to a service center for inspection.

## Regulatory Information for North America

**CAUTION:** Unauthorized modifications or changes not expressly approved by Sierra Wireless, Inc. could void compliance with regulatory rules, and thereby your authority to use this equipment.

---

**Caution:** *The AT&T Mobile Hotspot Elevate 4G must be 1 cm or more from users during operation, to satisfy FCC / IC RF exposure requirements.*

---

This device complies with Part 15 of the FCC Rules. Operation is subject to the condition that these devices do not cause harmful interference.

Where appropriate, the use of the equipment is subject to the following conditions:

---

**Warning: (EMI)** – *United States FCC Information – This equipment has been tested and found to comply with the limits pursuant to Part 15 of the FCC Rules. These limits are designed to provide reasonable protection against harmful interference in an appropriate installation. This equipment generates, uses, and can radiate radio frequency energy and, if not installed and used in accordance with the instructions, may cause harmful interference to radio communication. However, there is no guarantee that interference will not occur in a particular installation.*

---

If this equipment does cause harmful interference to radio or television reception, which can be determined by turning the equipment off and on, the user is encouraged to try to correct the interference by one or more of the following measures:

- Increase the separation between the equipment and receiver
- Connect the equipment into an outlet on a circuit different from that to which the receiver is connected
- Consult the dealer or an experienced radio/TV technician for help

If you have purchased this product under a United States Government contract, it shall be subject to restrictions as set forth in subparagraph (c)(1)(ii) of Defense Federal Acquisitions Regulations (DFARs) Section 252.227-7013 for Department of Defense contracts, and as set forth in Federal Acquisitions Regulations (FARs) Section 52.227-19 for civilian agency contracts or any successor regulations. If further government regulations apply, it is your responsibility to ensure compliance with such regulations.

# »» Index

## A

accessories  
    included, [12](#)  
    purchasing optional accessories, [12](#)  
add a wireless device, [20](#)  
Admin Login, [16](#)  
Admin Login, forgot, [46](#)  
audio alerts, [26](#)  
auto connect options, [17](#)

## B

battery, [24](#)  
    inserting, [13](#)  
    recharging, [30](#)  
battery life, [47](#)  
block users, [19](#)

## C

connect / disconnect button, [46](#)  
connect to the Internet, [13](#)  
connection preferences, [37](#)

## D

device information, view and save, [36](#)  
display options, [34](#)

## G

GPS, [23](#)

## H

homepage, accessing, [14](#)  
homepage, cannot access, [50](#)

## I

icons on the LCD screen, [10](#)

## L

LAN options, [44](#)  
LCD, [9](#)  
LCD screen not lit, [47](#)  
list of connected devices, view, [39](#)

## M

MAC filter, [42](#)  
microSD  
    accessing information on, [47](#)  
    inserting, [28](#)  
microSD card  
    accessing information on, [28](#)  
mobile hotspot, turn off, [47](#)  
mute switch, [9](#)

## N

network name does not appear in the list of networks, [49](#)  
no signal icon, [49](#)

## P

port forwarding, [42](#)  
power button, [9](#)  
power source, [12](#)

## R

regulatory information, [57](#)  
router options, import, export, [33](#)

## S

safety information, [57](#)  
security credentials, [16](#)  
Security credentials, forgot, [46](#)  
security, change settings, [27](#)  
SIM card, inserting, [31](#)  
SIM security, enable, [38](#)  
SMS messages, [22](#)  
specifications, [56](#)

## T

text messages. *See* SMS messages.  
troubleshooting, [49](#)

## U

Unable to connect to hotspot, [50](#)  
USB tethering, [33](#)

## V

view connected users, [19](#)  
Vista, [50](#)  
VPN passthrough, [42](#), [44](#)

**W**

WAN information, view, [37](#)

Wi-Fi Key, [16](#)

Wi-Fi Key, forgot, [46](#)

Wi-Fi network

    disconnect, [46](#)

    options, [39](#)

Wi-Fi radio is disabled, [49](#)

Wi-Fi range, [24](#)

Wi-Fi security options, [41](#)

Wi-Fi status, view, [39](#)

Wi-Fi, enable/disable, [19](#)

wireless devices, connecting to your Wi-Fi network, [21](#)

WPS, [21](#)



