

## Start Here

Please refer to the Reference Manual on your *Resource CD* for instructions on advanced configuration options.

**Estimated Completion Time: 30 minutes.**





**Tip:** Before mounting the WPN802 in a high location, first set up and test the WPN802 to verify wireless network connectivity.

## First, Set Up the WPN802

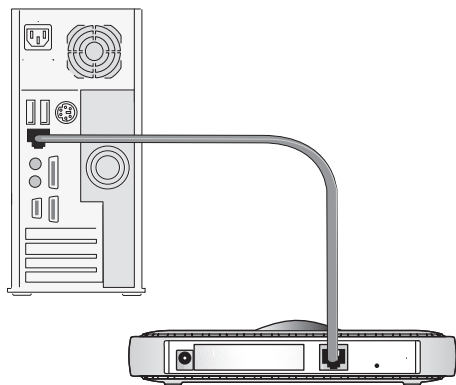
### 1. CONNECT THE WIRELESS ACCESS POINT TO YOUR COMPUTER

- Unpack the box and verify the contents.
- Prepare a computer with Internet access and an Ethernet adapter. If this computer is already part of your network, record its TCP/IP configuration settings. Configure the computer with a static IP address of 192.168.0.210 and 255.255.255.0 as the Subnet Mask.
- Connect an Ethernet cable from the WPN802 to the PC.
- Securely insert the other end of the cable into the WPN802 Ethernet port.



- Turn on your computer, and connect the power adapter to the WPN802. Then check the lights on the front:
  -  **Power:** The power light should be lit. If the power light is not lit, check the connections and check to see if the power outlet is controlled by a wall switch that is turned off.
  -  **Test:** The test light blinks when the WPN802 is first turned on.
  -  **WLAN:** The wireless light should be lit.
  -  **Ethernet:** The Ethernet (LAN) light should be lit (amber for a 10 Mbps connection and green for a 100 Mbps connection). If not, make sure the Ethernet cable is securely attached at both ends.

### 2. CONFIGURE LAN AND WIRELESS ACCESS

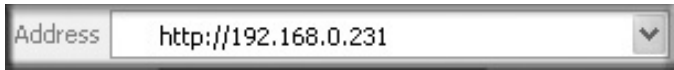
- Configure the WPN802 Ethernet port for LAN access.
  - Connect to the WPN802 by opening your browser and entering `http://192.168.0.231` in the address field.  

  - When prompted, enter **admin** for the user name and **password** for the password, both in lower case letters.
  - Click the Basic Settings link and configure the IP Settings for your network.
- Configure the wireless interface for wireless access. See the online help or the Reference Manual for full instructions.
- Test wireless connectivity using a computer with a wireless adapter configured according to the wireless settings you just set in the WPN802 to establish a wireless connection to the WPN802.

Now that you have finished the setup steps, you are ready to deploy the WPN802 in your network. If needed, you can now reconfigure the PC you used in step 1 back to its original TCP/IP settings.

## Deploy the WPN802

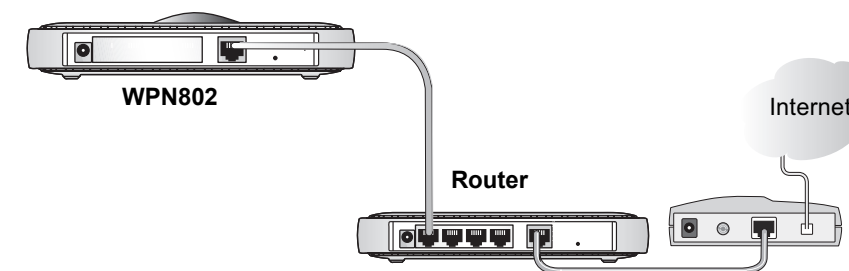
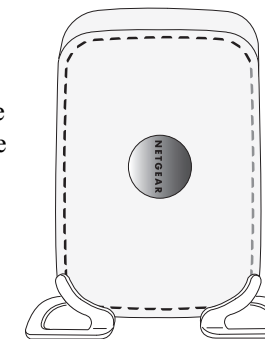
- Disconnect the WPN802 from the computer and place it where you will deploy it.  
The best location is elevated, such as wall mounted or on the top of a cubicle, at the center of your wireless coverage area, and within line of sight of all the mobile devices. If the WPN802 is on a metal surface it must be positioned vertically.
- Connect an Ethernet cable from your WPN802 Access Point to a LAN port on your router, switch, or hub.



- Connect the power adapter to the wireless access point and plug the power adapter in to a power outlet. The Power, WLAN and Ethernet lights should light up.

## Now, Verify Wireless Connectivity

Using a computer with an 802.11g or 802.11b wireless adapter, verify connectivity by using a browser such as Netscape® or Internet Explorer to connect to the Internet, or check for file and printer access on your network.

**Note:** If you cannot connect, see to Troubleshooting Tips in this guide or the Reference Manual on the *Resource CD* for the Wireless Access Point.

## Troubleshooting Tips

---

Here are some tips for correcting simple problems you may have.

### **No lights are lit on the access point.**

The access point has no power.

- Make sure the power cord is connected to the access point and plugged in to a working power outlet or power strip.
- Make sure you are using the correct NETGEAR power adapter supplied with your access point.

### **The Ethernet light is not lit.**

There is a hardware connection problem.

- Make sure the cable connectors are securely plugged in at the access point and the network device (hub, switch, or router).
- Make sure the connected device is turned on.

### **The WLAN light is not lit.**

The access point's antennas are not working.

- If the Wireless LAN activity light stays off, disconnect the adapter from its power source and then plug it in again.
- Contact NETGEAR if the WLAN light remains off.

### **I cannot configure the access point from a browser.**

Check these items:

- The WPN802 is properly installed, LAN connections are OK, and it is powered on. Check that the LAN port LED is green to verify that the Ethernet connection is OK.
- If you are using the NetBIOS name of the WPN802 to connect, ensure that your PC and the WPN802 are on the same network segment or that there is a WINS server on your network.
- If your PC uses a Fixed (Static) IP address, ensure that it is using an IP Address in the range of the WPN802. The WPN802 default IP Address is 192.168.0.231 and the

default Subnet Mask is 255.255.255.0. The WPN802 default setting is for a static IP address. If the network where you are connecting it is using DHCP, configure it accordingly. See the Reference Manual on the *Resource CD* for the Wireless Access Point for more details.

### **I cannot access the Internet or the LAN with a wireless capable computer.**

There is a configuration problem. Check these items:

- You may not have restarted the computer with the wireless adapter to have TCP/IP changes take effect. Restart the computer.
- The computer with the wireless adapter may not have the correct TCP/IP settings to communicate with the network. Restart the computer and check that TCP/IP is set up properly for that network. The usual setting for Windows on the Network Properties is set to "Obtain an IP address automatically."
- The access point's default values may not work with your network. Check the access point default configuration against the configuration of other devices in your network.
- For full instructions on changing the access point's default values, see the Reference Manual on the *Resource CD* for the Wireless Access Point.

## Technical Support

---

Thank you for selecting NETGEAR products.

To register your product, go to: <http://www.NETGEAR.com/register>

Go to <http://www.NETGEAR.com/support> for support information.



201-10538-01

May 2005

©2005 by NETGEAR, Inc. All rights reserved.

NETGEAR is a registered trademark of NETGEAR, Inc. in the United States and/or other countries. Other brand and product names are trademarks or registered trademarks of their respective holders. Information is subject to change without notice.