



Nighthawk X4S AC2600 WiFi VDSL/ADSL Modem Router

User Manual

Model D7800

May 2018
202-11572-02

350 E. Plumeria Drive
San Jose, CA 95134
USA

Support

Thank you for purchasing this NETGEAR product. You can visit www.netgear.com/support to register your product, get help, access the latest downloads and user manuals, and join our community. We recommend that you use only official NETGEAR support resources.

Conformity

For the current EU Declaration of Conformity, visit http://kb.netgear.com/app/answers/detail/a_id/11621.

Compliance

For regulatory compliance information, visit <http://www.netgear.com/about/regulatory>.

See the regulatory compliance document before connecting the power supply.

Trademarks

© NETGEAR, Inc., NETGEAR and the NETGEAR Logo are trademarks of NETGEAR, Inc. Any non-NETGEAR trademarks are used for reference purposes only.

Contents

Chapter 1 Hardware Overview of the Modem Router

Unpack Your Modem Router.....	11
Attach the Antennas.....	11
Top Panel With LEDs.....	12
Back Panel With Ports, Buttons, Connectors, and Switch.....	15
USB Ports on the Left Panel.....	16
eSATA Port on the Right Panel.....	16
Connect an eSATA Device.....	17
Bottom Panel Product Label.....	17

Chapter 2 Install and Access the Modem Router and Its Network

Position Your Modem Router.....	20
Connect to the Modem Router.....	21
Connect to the Modem Router Through an Ethernet Cable.....	21
Join the WiFi Network of the Modem Router.....	21
Manual Method.....	21
Wi-Fi Protected Setup Method.....	22
Types of Logins.....	22
Automatic Internet Setup.....	22
Set Up Your Modem Router for DSL Service.....	23
DSL Service.....	24
Cable the Modem Router for DSL Service and Access the Modem Router....	24
Set Up the Modem Router for Cable or Fiber Service.....	31
Log In to the Modem Router After Setup to View or Change Settings.....	37
Change the Language.....	38
Change the admin Password.....	39
Set Up Password Recovery.....	40
Let the Modem Router Automatically Update Its Firmware.....	40
Access the Modem Router With the NETGEAR genie App.....	41

Chapter 3 Manage the Internet Settings Manually

Use the Internet Setup Wizard After Initial Setup.....	44
Manually Set Up an ADSL Internet Connection.....	49
Specify an ADSL Connection Without a Login.....	49
Specify an ADSL Connection With a Login and PPPoA or PPPoE Service....	54
Manually Set Up a VDSL Internet Connection.....	58
Specify a VDSL Connection Without a Login.....	58
Specify a VDSL Connection With a Login and PPPoE Service.....	62
Manually Set Up a Cable or Fiber Internet Connection.....	66
Specify a Cable or Fiber Connection Without a Login.....	67
Specify a Cable or Fiber Connection With a Login and PPPoE Service.....	70

Nighthawk X4S AC2600 WiFi VDSL/ADSL Modem Router Model D7800

Specify a Cable or Fiber Connection With a Login and PPTP or L2TP Service.....	74
Specify an IPv6 Internet Connection.....	77
IPv6 Internet Connections and IPv6 Addresses.....	78
Set Up an IPv6 Connection Through Auto Detect.....	78
Set Up an IPv6 6to4 Tunnel Connection.....	80
Set Up an IPv6 Pass-Through Connection.....	82
Set Up an IPv6 Fixed Connection.....	82
Set Up an IPv6 DHCP Connection.....	84
Set Up an IPv6 PPPoE Connection.....	86
Set Up an IPv6 Connection Through Auto Config.....	88
Manage the MTU Size.....	90
MTU Concepts.....	90
Change the MTU Size.....	91

Chapter 4 Manage the Basic WiFi Network Settings

Manage the Basic WiFi Settings and WiFi Security of the Main Network.....	93
View or Change the Basic WiFi Settings.....	93
Configure WPA/WPA2 Enterprise WiFi Security.....	99
Configure WEP Legacy WiFi Security.....	100
Use WPS to Add a Device to the WiFi Network.....	102
Use WPS With the Push Button Method.....	102
Use WPS With the PIN Method.....	103
Manage the Basic WiFi Settings and WiFi Security of the Guest Network.....	105
Control the WiFi Radios.....	108
Use the WiFi On/Off Button.....	109
Enable or Disable the WiFi Radios.....	109

Chapter 5 Control Access to the Internet

Set Up Parental Controls.....	112
Allow or Block Access to Your Network.....	113
Enable and Manage Network Access Control.....	113
Manage Network Access Control Lists.....	115
Add Devices to or Remove Them From the Blocked List.....	115
Add Devices to or Remove Them From the Allowed List.....	117
Use Keywords to Block Internet Sites.....	118
Set Up Blocking.....	118
Remove a Keyword or Domain From the Blocked List.....	120
Remove All Keywords and Domains From the Blocked List.....	120
Specify a Trusted Computer.....	121
Manage Simple Outbound Firewall Rules for Services and Applications.....	122
Add an Outbound Firewall Rule.....	122
Add an Outbound Firewall Rule for a Custom Service or Application.....	124
Change an Outbound Firewall Rule.....	126
Remove an Outbound Firewall Rule.....	127
Set Up a Schedule for Keyword Blocking and Outbound Firewall Rules.....	127
Set Up Security Event Email Notifications.....	129

Chapter 6 Optimize Performance

Use Dynamic QoS to Optimize Internet Traffic Management..... 132
 Enable Dynamic QoS..... 132
 Enable or Disable the Automatic QoS Database Update..... 133
 Manually Update the Dynamic QoS Database..... 134
 Participate in Dynamic QoS Analytics..... 135
Manage Wi-Fi Multimedia Quality of Service..... 136
Manage Beamforming..... 137
Improve Network Connections With Universal Plug-N-Play..... 138

Chapter 7 Share a Storage Device

Connect an eSATA Device to the Modem Router..... 141
USB Device Requirements..... 141
Connect a USB Device to the Modem Router..... 141
Access a Storage Device Connected to the Modem Router..... 142
 Access the Storage Device From a Windows-Based Computer..... 142
 Access the Storage Device From a Mac..... 143
Back Up Windows Computers With ReadySHARE Vault..... 143
Back Up Mac Computers With Time Machine..... 144
 Set Up a Storage Device on a Mac..... 144
 Prepare to Back Up a Large Amount of Data..... 144
 Use Time Machine to Back Up Onto a Storage Device..... 145
Manage Access to a Storage Device..... 146
Enable FTP Access Within Your Network..... 148
View Network Folders on a Device..... 149
Add a Network Folder on a Storage Device..... 151
Change a Network Folder, Including Read and Write Access, on a USB Drive.. 152
Approve Storage Devices..... 154
Safely Remove a USB Device..... 156

Chapter 8 Manage Dynamic DNS and Access Storage Devices Through the Internet

Set Up and Manage Dynamic DNS..... 158
 Your Personal FTP Server..... 158
 Set Up a New Dynamic DNS Account..... 159
 Specify a DNS Account That You Already Created..... 160
 Change the Dynamic DNS Settings..... 162
Access Storage Devices Through the Internet..... 162
 Access Storage Devices From a Remote Computer..... 162
 Set Up FTP Access Through the Internet..... 162
 Use FTP to Access Storage Devices Through the Internet..... 164

Chapter 9 Use the Modem Router as a Media Server

Specify ReadyDLNA Media Server Settings..... 167
Rescan the Media Files for Content..... 167
Play Music From a Storage Device With iTunes Server..... 168
Play Media From a USB Device on TiVo..... 169

Nighthawk X4S AC2600 WiFi VDSL/ADSL Modem Router Model D7800

Set Up the Modem Router to Work With TiVo.....	170
Play Videos.....	170
Play Music or View Photos.....	170
Copy TiVo Files to a Computer.....	170

Chapter 10 Share a USB Printer

Install the Printer Driver and Cable the Printer.....	172
Download the ReadySHARE Printer Utility.....	172
Install the ReadySHARE Printer Utility.....	172
Use the Shared Printer.....	174
Manually Connect and Print.....	174
Print and Release the Printer.....	175
View or Change the Status of a Printer.....	175
Use the Scan Feature of a Multifunction USB Printer.....	176
Manage the NETGEAR USB Control Center Settings.....	177
Turn Off Automatic Startup of the NETGEAR USB Control Center.....	177
Change the NETGEAR USB Control Center Language.....	178
Specify the USB Control Center Time-Out.....	178

Chapter 11 Manage the WAN and LAN Network Settings

Change the Physical WAN Connection Preference.....	180
Enable Bridge Mode for IPTV Devices.....	180
Enable and Configure a VLAN.....	182
Set Up a Bridge for a Port Group or VLAN Tag Group.....	184
Set Up a Bridge for a Port Group.....	185
Set Up a Bridge for a VLAN Tag Group.....	186
Manage the WAN Security Settings.....	187
Set Up a Default DMZ Server.....	188
Manage IGMP Proxying.....	189
Manage NAT Filtering.....	189
Manage the SIP Application-Level Gateway.....	190
Manage the Modem Routers's LAN IP Address Settings.....	191
Manage the Router Information Protocol Settings.....	192
Manage the DHCP Server Address Pool.....	193
Manage Reserved LAN IP Addresses.....	194
Reserve a LAN IP Address.....	194
Change a Reserved IP Address.....	195
Remove a Reserved IP Address Entry.....	195
Disable the Built-In DHCP Server.....	196
Change the Modem Router's Device Name.....	196
Set Up and Manage Custom Static Routes.....	197
Set Up a Static Route.....	198
Change a Static Route.....	199
Remove a Static Route.....	200

Chapter 12 Manage the Modem Router and Monitor the Traffic

Update the Firmware of the Modem Router.....	202
Check for New Firmware and Update the Modem Router.....	202

Nighthawk X4S AC2600 WiFi VDSL/ADSL Modem Router Model D7800

Manually Upload New Firmware and Update the Modem Router.....	203
Manage the Configuration File of the Modem Router.....	204
Back Up the Settings.....	204
Restore the Settings.....	205
Recover the admin Password.....	205
Return the Modem Router to Its Factory Default Settings.....	206
Use the Reset Button.....	206
Erase the Settings.....	207
Disable LED Blinking or Turn Off LEDs.....	208
View the Status and Statistics of the Modem Router.....	209
View Information About the Modem Router and the Internet and WiFi Settings.....	209
View the Traffic Statistics.....	213
Change the Traffic Statistics Polling Frequency.....	214
View, Renew, or Release the TCP/IP Internet Connection.....	215
View, Establish, or Terminate the PPPoE or PPPoA Internet Connection.....	216
View, Establish, or Terminate the PPTP or L2TP Internet Connection.....	217
View Devices Currently on the Network.....	218
Manage the Activity Log.....	219
View, Email, or Clear the Logs.....	219
Specify Which Activities Are Logged.....	219
Monitor and Meter Internet Traffic.....	220
Start the Traffic Meter Without Traffic Volume Restrictions.....	220
View the Internet Traffic Volume and Statistics.....	221
Restrict Internet Traffic by Volume.....	222
Restrict Internet Traffic by Connection Time.....	224
Unblock the Traffic Meter After the Traffic Limit Is Reached.....	225
Manage the Modem Router Remotely.....	226

Chapter 13 Manage the Advanced WiFi Features

Set Up a WiFi Schedule.....	229
Manage the WPS Settings.....	230
Manage Advanced WiFi Settings.....	231
Set Up the Modem Router as a WiFi Access Point Only.....	233
Set Up a WiFi Bridge.....	234

Chapter 14 Use VPN to Access Your Network

Set Up a VPN Connection.....	239
Specify VPN Service in the Modem Router.....	239
Install OpenVPN Software on a Windows Computer.....	240
Install OpenVPN Software on a Mac Computer.....	242
Use a VPN Tunnel on a Windows-Based Computer.....	243
Use VPN to Access the Modem Router's USB Device and Media From a Windows-Based Computer.....	245
Use VPN to Access Your Internet Service at Home.....	245
Set Up VPN Client Internet Access in the Modem Router.....	245
Block VPN Client Internet Access in the Modem Router.....	246
Use a VPN Tunnel to Access Your Internet Service at Home.....	247

Chapter 15 Manage Port Forwarding and Port Triggering

Manage Port Forwarding to a Local Server for Services and Applications.....249
 Forward Incoming Traffic for a Default Service or Application.....249
 Add a Port Forwarding Rule With a Custom Service or Application.....250
 Change a Port Forwarding Rule.....252
 Remove a Port Forwarding Rule.....253
 Application Example: Make a Local Web Server Public.....253
 How the Modem Router Implements the Port Forwarding Rule.....254
Manage Port Triggering for Services and Applications.....254
 Add a Port Triggering Rule.....255
 Change a Port Triggering Rule.....257
 Remove a Port Triggering Rule.....258
 Specify the Time-Out for Port Triggering.....258
 Disable Port Triggering.....259
 Application Example: Port Triggering for Internet Relay Chat.....260

Chapter 16 Troubleshooting

Reboot the Modem Router From Its Web Page.....262
Quick Tips for Troubleshooting.....262
Troubleshoot With the LEDs.....263
 Power LED Is Off.....264
 Power LED Remains Solid Amber.....264
 WiFi LED Is Off.....264
You Cannot Log In to the Modem Router.....265
Troubleshoot the Internet Connection.....265
 Troubleshoot the DSL/Internet Link.....265
 DSL/Internet LED Is Solid White.....265
 DSL/Internet LED Is Blinking White (DSL Connection Only).....266
 DSL/Internet LED Is Off.....266
 Obtain an Internet IP Address.....266
 Verify the PPPoE, PPPoA, PPTP, or L2TP Connection.....268
 Troubleshoot Internet Browsing.....268
Changes Are Not Saved.....269
Troubleshoot the WiFi Connectivity.....269
Troubleshoot Your Network Using the Ping Utility.....270
 Test the LAN Path to Your Modem Router.....270
 Test the Path From Your Computer to a Remote Device.....271

Chapter 17 Supplemental Information

Factory Settings.....273
Technical Specifications.....275

Hardware Overview of the Modem Router 1

The NETGEAR® *Nighthawk® X4S AC2600 WiFi VDSL/ADSL Modem Router Model D7800*, in this manual referred to as the modem router, delivers combined WiFi connection speeds of up to approximately AC2600 WiFi (800 Mbps¹ on 2.4 GHz² 802.11n and 1733 Mbps³ on 5 GHz 802.11ac). Both the 2.4 GHz and 5 GHz radios can be active simultaneously.

The Nighthawk X4S is ideal for homes with a high volume of network and Internet traffic from gaming and streaming. It supports the following advanced features:

- Multi-user MIMO (MU-MIMO) for faster speeds with simultaneously streamed data for up to three devices.
- Quad Stream WiFi for up to four data streams per WiFi band to maximize connection speed.
- Dynamic QoS for performance optimization based on applications and devices, with automatic cloud updates to optimize the most popular applications and services.

The Nighthawk X4S also provides fast central storage, backup, and streaming to every device in your home with two USB 3.0 ports (10 times faster than USB 2.0) and an eSATA port. Sharing content across your network is easy, whether you are accessing stored photos and music or printing over WiFi. Stream your stored media files on any device anywhere on the network. Share your music with AirPlay-compatible devices from a USB hard drive connected to the modem router. Use the free NETGEAR ReadySHARE Vault app to back up your Windows computers to a USB hard drive connected to the Nighthawk X4S.

The modem router is compatible with most major DSL Internet service providers and also supports cable or fiber Internet service.

1. Maximum WiFi signal rate derived from IEEE standard 802.11 specifications. Actual data throughput and WiFi coverage will vary. Network conditions and environmental factors, including volume of network traffic, building materials and construction, and network overhead, lower actual data throughput rate and WiFi coverage. NETGEAR makes no express or implied representations or warranties about this product's compatibility with any future standards. 802.11ac 1733 Mbps is approximately 4x faster than 802.11n 450 Mbps.

2. The 2.4 GHz performance mode requires 256 QAM support on the WiFi client.

3. Up to 1733 Mbps WiFi speeds can be achieved when you are connecting to other 802.11ac 1733 Mbps devices.

This chapter contains the following sections:

- [Unpack Your Modem Router](#) on page 11
- [Attach the Antennas](#) on page 11
- [Top Panel With LEDs](#) on page 12
- [Back Panel With Ports, Buttons, Connectors, and Switch](#) on page 15
- [USB Ports on the Left Panel](#) on page 16
- [eSATA Port on the Right Panel](#) on page 16
- [Connect an eSATA Device](#) on page 17
- [Bottom Panel Product Label](#) on page 17

Note For more information about the topics that are covered in this manual, visit the support website at support.netgear.com.

Note Firmware updates with new features and bug fixes are made available from time to time at downloadcenter.netgear.com. You can check for and download new firmware manually. If the features or behavior of your product does not match what is described in this guide, you might need to update your firmware.

Note In this manual, the terms *wireless* and *WiFi* are interchangeable.

Unpack Your Modem Router

Your package contains the following items.

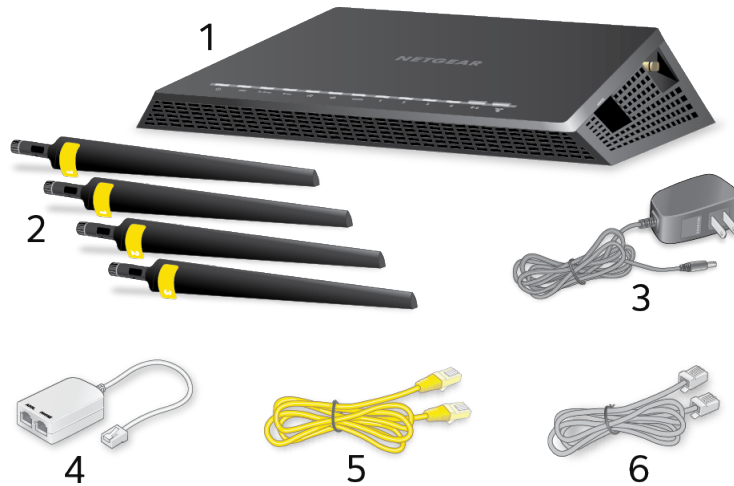

Figure 1. Package contents for the modem router

Table 1. Legend

1.	Modem router
2.	Antennas (4)
3.	Power supply (varies by region)
4.	DSL microfilter (varies by region)
5.	Ethernet cable
6.	Phone cable

Your package might contain more items. The filter or phone cable provided depends on the region. In some regions, a CD is included in the package.

Attach the Antennas

The modem router comes with four antennas.

▶ To attach the antennas:

1. To determine where to attach the antennas, match the labels on the antennas with the labels on the modem router.

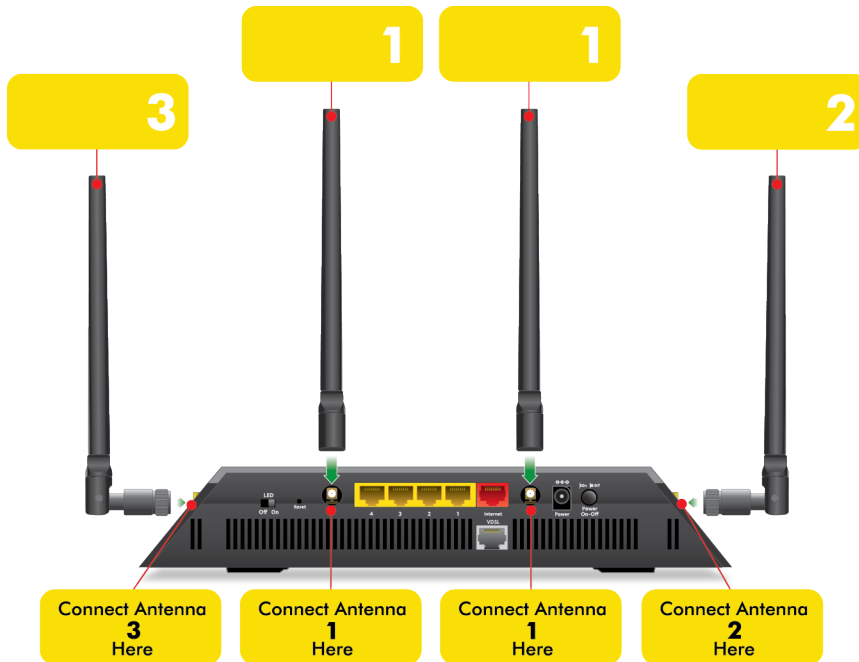

2. Align the antennas with the antenna posts on the modem router.
3. Attach the antennas on the threaded antenna posts.
4. Position the antennas for the best WiFi performance.
We recommend that you position all of the antennas vertically, as shown.

Top Panel With LEDs

The status LEDs and buttons are located on the top panel of the modem router.

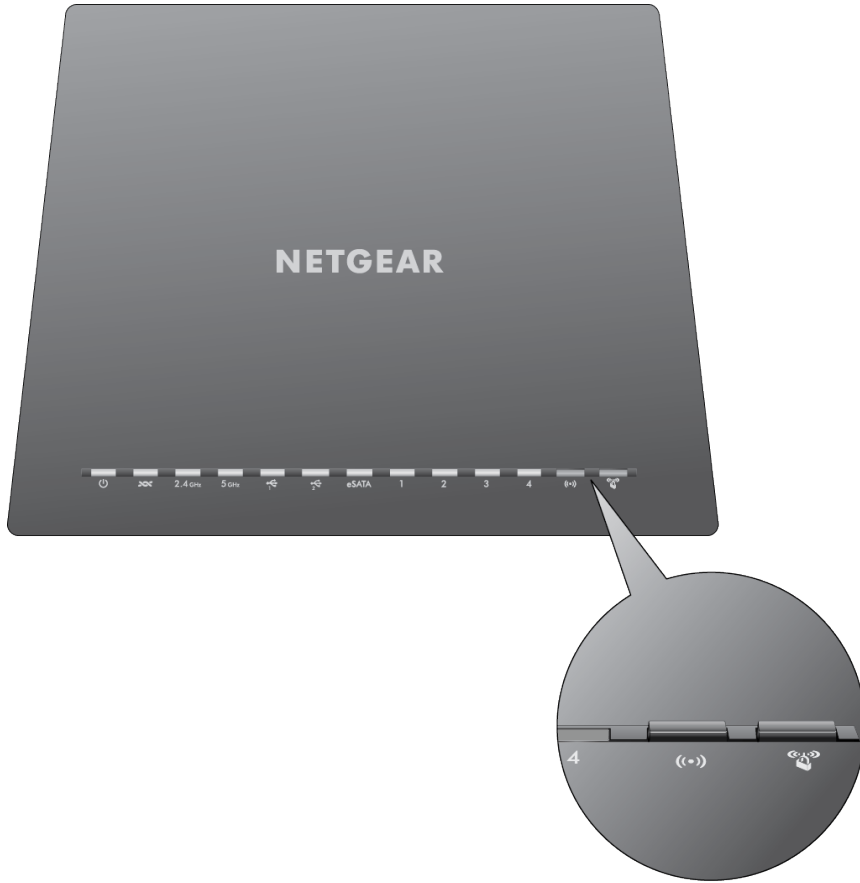

Figure 2. LEDs and buttons of the modem router

Table 2. LED and button descriptions









LED	Description
Power 	<ul style="list-style-type: none"> • Solid amber. The modem router is starting. If the Power LED lights solid amber during any other time, a power-on self-test (POST) failure or device malfunction occurred. For more information, see Power LED Remains Solid Amber on page 264. • Blinking amber. The modem router was reset to factory default settings and is restarting. For more information, see Return the Modem Router to Its Factory Default Settings on page 206. • Solid white. The modem router is ready. • Off. Power is not supplied to the modem router. For more information, see Power LED Is Off on page 264.
DSL/Internet 	<ul style="list-style-type: none"> • Solid white. The modem router is connected to a DSL service or cable or fiber modem and detected an Internet connection. • Solid amber. The modem router is not connected to a DSL service or cable or fiber modem or did not detect an Internet connection. For more information, see Troubleshoot the Internet Connection on page 265. • Blinking white. The modem router is negotiating the best possible speed on the DSL line. • Alternating white and amber. The traffic meter is enabled and the traffic limit is reached. • Off. The modem router cannot connect to the Internet or the Internet connection failed.
2.4 GHz WiFi 	<ul style="list-style-type: none"> • Solid white. The 2.4 GHz WiFi radio is operating. • Blinking white. The modem router is sending or receiving WiFi traffic over the 2.4 GHz radio. • Off. The 2.4 GHz WiFi radio is off.
5 GHz WiFi 	<ul style="list-style-type: none"> • Solid white. The 5 GHz WiFi radio is operating. • Blinking white. The modem router is sending or receiving WiFi traffic over the 5 GHz radio. • Off. The 5 GHz WiFi radio is off.
USB 3.0 port 1 and USB 3.0 port 2 	<ul style="list-style-type: none"> • Solid white. A USB device is connected and is ready. • Blinking white. Data is being transmitted to or from the USB device. • Off. No USB device is connected, or someone clicked the Safely Remove Hardware button and it is now safe to remove the attached USB device.

Table 2. LED and button descriptions (Continued)

LED	Description
	<ul style="list-style-type: none"> Solid white. The modem router is connected to an eSATA device that is ready. Blinking white. An eSATA device is plugged into the modem router and is trying to connect. Off. No eSATA device is connected.
	<p>The LED color indicates the speed: white for Gigabit Ethernet connections and amber for 100 Mbps or 10 Mbps Ethernet connections.</p> <ul style="list-style-type: none"> Solid white or solid amber. A powered-on device is connected to the Ethernet port. Blinking white or blinking amber. Data is being transmitted over the port. Off. No powered-on device is connected to the Ethernet port.
WiFi On/Off button with WiFi LED 	<p>Pressing this button for two seconds turns the 2.4 GHz and 5 GHz WiFi radios on and off. If this LED is lit, the WiFi radios are on. If this LED is off, the WiFi radios are turned off and you cannot use WiFi to connect to the modem router.</p> <p>For more information, see Control the WiFi Radios on page 108 and Troubleshoot With the LEDs on page 263.</p>
WPS button with WPS LED 	<p>This button lets you use WPS to join the WiFi network without typing the WiFi password. The WPS LED blinks white during this process and then lights solid white.</p> <p>For more information, see Use WPS to Add a Device to the WiFi Network on page 102.</p>

You can use the **LED On/Off** switch on the back panel of the modem router to turn most LEDs on the top of the modem router on or off (see [Back Panel With Ports, Buttons, Connectors, and Switch](#) on page 15). If you turn off the LEDs, the Power LED remains on.

Back Panel With Ports, Buttons, Connectors, and Switch

The back panel of the modem router provides ports, buttons, antenna connectors, a DC power connector, and an LED switch. For information about attaching the antennas, see [Attach the Antennas](#) on page 11.

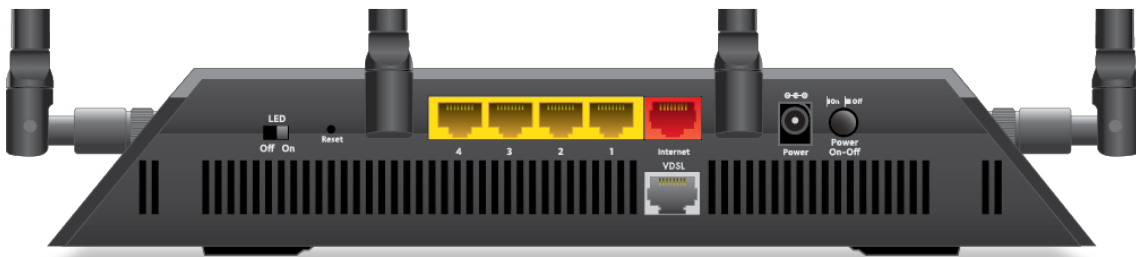

Figure 3. Modem router back panel

Nighthawk X4S AC2600 WiFi VDSL/ADSL Modem Router Model D7800

In addition to the antennas, viewed from left to right, the back panel contains the following components:

- **LED Off/On switch.** Move the **LED Off/On** switch to to the **Off** position to turn off all LEDs, except for the Power LED.
- **Reset button.** For information about using the **Reset** button, see *Use the Reset Button* on page 206.
- **Ethernet LAN ports.** Four Gigabit Ethernet RJ-45 LAN ports to connect the modem router to LAN devices. These ports are colored yellow.
- **Internet port.** One Gigabit Ethernet RJ-45 WAN port to connect the modem router to a fiber or cable modem. This port is colored red.

Note You can use either the Internet port or the DSL port for WAN connectivity.

- **DSL port.** One RJ-11 DSL port for connecting the modem router to an ADSL or VDSL line. This port is colored gray. In the previous figure, the DSL port is marked VDSL.

Note You can use either the DSL port or the Internet port for WAN connectivity.

- **DC power connector.** Connect the power adapter that came in the product package to the DC power connector.
- **Power On/Off button.** Press the **Power On/Off** button to provide power to the modem router.

USB Ports on the Left Panel

Two 3.0 USB ports are located on the left panel.



Figure 4. USB ports

eSATA Port on the Right Panel

An eSATA port is located on the right panel.

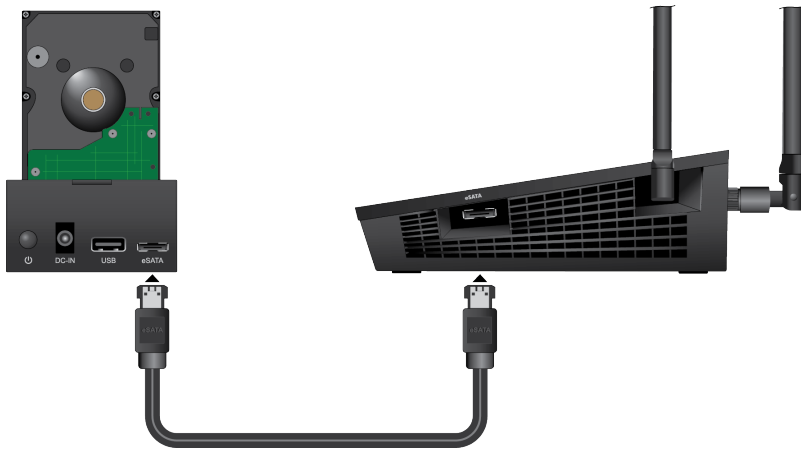

Figure 5. eSATA port

Connect an eSATA Device

▶ To connect an eSATA device:

- Use an eSATA cable to connect your device to the eSATA port on the side of the modem router as shown.



Bottom Panel Product Label

The product label on the bottom panel of the modem router lists the login information, WiFi network name (SSID) and password (network key), serial number, and MAC address of the modem router.

Nighthawk X4S AC2600 WiFi VDSL/ADSL Modem Router Model D7800

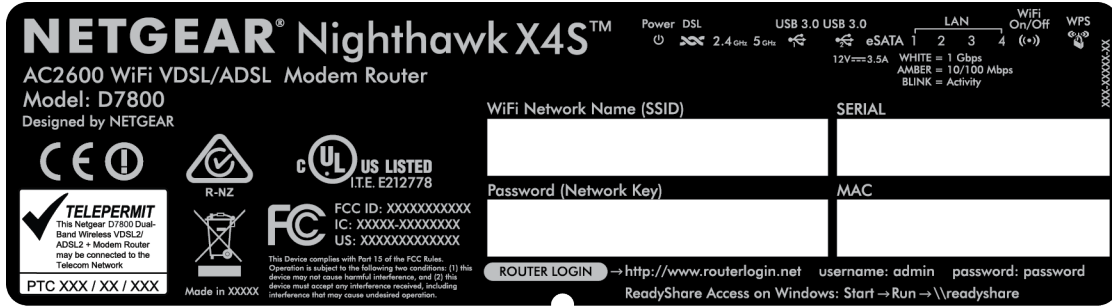

Figure 6. Modem router product label

Install and Access the Modem Router and Its Network

2

This chapter describes how you can install and access the modem router and its network.

The chapter contains the following sections:

- *Position Your Modem Router* on page 20
- *Connect to the Modem Router* on page 21
- *Set Up Your Modem Router for DSL Service* on page 23
- *Set Up the Modem Router for Cable or Fiber Service* on page 31
- *Log In to the Modem Router After Setup to View or Change Settings* on page 37
- *Change the Language* on page 38
- *Change the admin Password* on page 39
- *Set Up Password Recovery* on page 40
- *Let the Modem Router Automatically Update Its Firmware* on page 40
- *Access the Modem Router With the NETGEAR genie App* on page 41

Position Your Modem Router

The modem router lets you access your network anywhere within the operating range of your WiFi network. However, the operating distance or range of your WiFi connection can vary significantly depending on the physical placement of your modem router. For example, the thickness and number of walls the WiFi signal passes through can limit the range.

Additionally, other WiFi access points in and around your home might affect your modem router's signal. WiFi access points are routers, repeaters, WiFi range extenders, and any other device that emits a WiFi signal for network access.

Position your modem router according to the following guidelines:

- Place your modem router near the center of the area where your computers and other devices operate and within line of sight to your WiFi devices.
- Make sure that the modem router is within reach of an AC power outlet and near Ethernet cables for wired computers.
- Place the modem router in an elevated location, minimizing the number walls and ceilings between the modem router and your other devices.
- Place the modem router away from electrical devices such as these:
 - Ceiling fans
 - Home security systems
 - Microwaves
 - Computers
 - Base of a cordless phone
 - 2.4 GHz cordless phone
 - 5 GHz cordless phone
- Place the modem router away from large metal surfaces, large glass surfaces, insulated walls, and items such as these:
 - Solid metal door
 - Aluminum studs
 - Fish tanks
 - Mirrors
 - Brick
 - Concrete

If you are using adjacent access points, use different radio frequency channels to reduce interference.

Connect to the Modem Router

During and after installation, you can connect to the modem router's network through a wired or WiFi connection. If you set up your computer to use a static IP address, change the settings of your computer so that it uses Dynamic Host Configuration Protocol (DHCP).

Connect to the Modem Router Through an Ethernet Cable

You can connect your computer to the modem router using an Ethernet cable and join the modem router's local area network (LAN).

► **To connect your computer to the modem router with an Ethernet cable:**

1. Make sure that the modem router is receiving power (its Power LED is lit).
2. Connect an Ethernet cable to an Ethernet port on your computer.
3. Connect the other end of the Ethernet cable to one of the numbered Ethernet ports.
Your computer connects to the local area network (LAN). A message might display on your computer screen to notify you that an Ethernet cable is connected.

Join the WiFi Network of the Modem Router

Choose either the manual or the WPS method to add a WiFi device such as a WiFi-enabled computer, an iPhone, an iPad, another mobile device, or a gaming device to the WiFi network of the modem router.

Manual Method

On the WiFi device that you want to connect to the modem router, you can use the software application that manages your WiFi connections.

► **To connect a device manually to the WiFi network of the modem router:**

1. Make sure that the modem router is receiving power (its Power LED is lit).
2. On the WiFi device that you want to connect to your modem router, open the software application that manages your WiFi connections.
This software scans for all WiFi networks in your area.
3. Look for the modem router's network and select it.
If you did not change the name of the network during the setup process, look for the default WiFi network name (SSID) and select it. The default SSID is on the modem router label.



Nighthawk X4S AC2600 WiFi VDSL/ADSL Modem Router Model D7800

4. Enter the modem router WiFi password.
The default WiFi password (also referred to as the *network key* or *passphrase*) is also on the modem router label.
5. Click the **Connect** button.
The device connects to the WiFi network of the modem router.

Wi-Fi Protected Setup Method

Wi-Fi Protected Setup (WPS) is a standard for easily adding computers and other devices to a home network while maintaining security. To use WPS (Push 'N' Connect), make sure that all WiFi devices to be connected to the network are Wi-Fi certified and support WPS. During the connection process, the client gets the security settings from the modem router so that every device in the network supports the same security settings.

► To use WPS to connect a computer or mobile device to the WiFi network of the modem router:

1. Make sure that the modem router is receiving power (its Power LED is lit).
2. Check the WPS instructions for your computer or mobile device.
3. Press the **WPS** button of the modem router for three seconds.
4. Within two minutes, press the **WPS** button on your computer or mobile device, or follow the WPS instructions that came with the device.
The WPS process automatically sets up the device with the network password and connects the device to the WiFi network of the modem router.

For more information, see [Use WPS to Add a Device to the WiFi Network](#) on page 102.

Types of Logins

Separate types of logins serve different purposes. This section describes the differences so that you know which login to use when.

Types of logins:

- **ISP login.** The login that your Internet service provider (ISP) gave you logs you in to your Internet service. Your ISP gave you this login information in a letter or some other way. If you cannot find this login information, contact your ISP.
- **WiFi network key or password.** Your modem router is preset with a unique WiFi network name (SSID) and password for WiFi access. This information is on the modem router label. Use this information to connect a computer or mobile device to the WiFi network of the modem router.
- **Modem router login.** This logs you in to the modem router's web pages from a web browser as admin.

Automatic Internet Setup

You can use NETGEAR genie to set up the modem router automatically, or you can use the modem router's web pages to set up the modem router manually.

Nighthawk X4S AC2600 WiFi VDSL/ADSL Modem Router Model D7800

Automatic Internet setup with NETGEAR genie functions with both types of Internet service that the modem router supports:

- **DSL service.** If you install your modem router for DSL service (the modem router supports ADSL and VDSL service), you can set up your modem router with NETGEAR genie, which launches the first time that you set up the Internet connection for your modem router. NETGEAR genie runs on any device with a web browser.
For more information, see [Set Up Your Modem Router for DSL Service](#) on page 23.
- **Cable or fiber service.** If you install your modem router for cable or fiber service, you can set up your modem router with NETGEAR genie, which launches the first time that you set up the Internet connection for your modem router. NETGEAR genie runs on any device with a web browser.
For more information, see [Set Up the Modem Router for Cable or Fiber Service](#) on page 31.

Note After initial installation and setup, the NETGEAR Setup Wizard is always accessible to assist you with setting up an installation with DSL service or an installation with cable or fiber service. For more information, see [Use the Internet Setup Wizard After Initial Setup](#) on page 44.

Whether you install your modem router for DSL service or for cable or fiber service, you can always use the modem router's web pages to set up the modem router manually.

Before you start the setup process, get your ISP information and make sure that the settings that are described here are specified for the computers and devices in the network.

When your Internet service starts, your Internet service provider (ISP) typically gives you all the information that you need to connect to the Internet. For DSL service, you might need the following information to set up your modem router:

- The ISP configuration information for your DSL account
- ISP login name and password
- Fixed or static IP address settings (special deployment by ISP; this setting is rare)

If you cannot locate this information, ask your ISP to provide it. When your Internet connection is working, you no longer need to launch the ISP login program on your computer to access the Internet. When you start an Internet application, your modem router automatically logs you in.

Set Up Your Modem Router for DSL Service

You can install your modem router for DSL service or for cable or fiber (Ethernet WAN) service. If you use a DSL modem, follow the procedure that is described in [Cable the Modem Router for DSL Service and Access the Modem Router](#) on page 24. If you use a cable or fiber modem, follow the procedure that is described in [Set Up the Modem Router for Cable or Fiber Service](#) on page 31.

DSL Service

Make sure that your ADSL or VDSL service is active before you install the modem router. You need the following information to install your DSL modem and connect to the Internet:

- **DSL user name and password.** This information is included in the welcome letter that your DSL Internet service provider (ISP) sent you when you signed up for your service. Record your DSL Internet service account user name and password.
- **Your telephone number or DSL account number.** If you do not use voice service, you can use your DSL account number in place of a phone number.

If you do not know or cannot locate your DSL user name and password, call your DSL ISP. Be specific when speaking with your DSL ISP. For example, you could say, “I need my DSL service user name and password. Can you help me?”

Note If your provider says that they do not support NETGEAR services, tell them that you need only your DSL user name and password. You do not need support.

Cable the Modem Router for DSL Service and Access the Modem Router

The following figure shows the cabling of your modem router for DSL service.

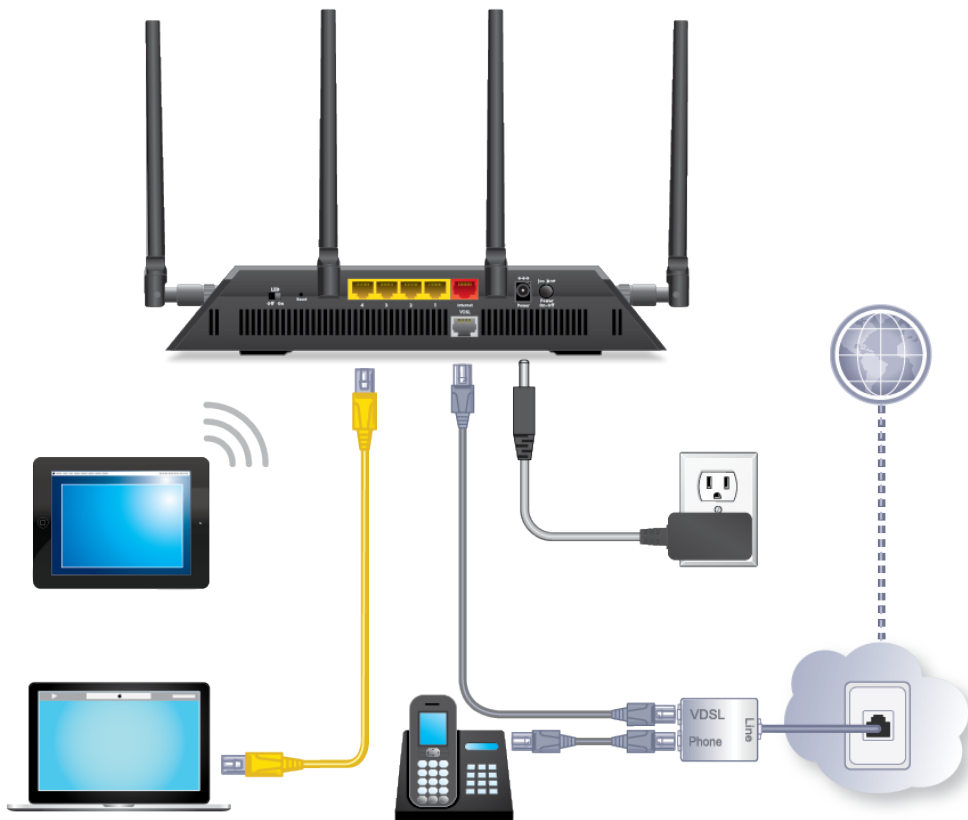





Figure 7. Modem router cabling for DSL service

► To connect your modem router to a DSL service:

1. Unplug your DSL modem's power, leaving the DSL modem connected to the wall jack for your Internet service.
2. If your DSL modem includes a battery backup, remove the battery.
3. Install an ADSL or DSL microfilter between the phone line and the phone. The product package contains either an ADSL or DSL microfilter.
4. Use a phone cable to connect the microfilter to the gray DSL port on the modem router. The product package contains a phone cable.
5. If your DSL modem includes a battery backup, reinsert the battery.
6. Plug in your DSL modem's power and turn on your DSL modem.
7. Connect the power adapter to the modem router and plug it into an electrical outlet. Wait for the Power LED  to light solid white, which takes about two minutes.
8. If the Power LED does not light, press the **Power On/Off** button. Wait for the WiFi LED  to light solid white.
9. If the WiFi LED does not light, press the **WiFi On/Off** button .

Nighthawk X4S AC2600 WiFi VDSL/ADSL Modem Router Model D7800

10. Connect a computer to the modem router by one of the following methods:

- **Ethernet cable.** Use an Ethernet cable to connect your computer to a yellow Ethernet LAN port on the modem router.
The product package contains a yellow Ethernet cable.
Your computer connects to the modem router's LAN.
- **WiFi.** Connect to the default WiFi network of the modem router:
 - a. On your computer or WiFi device, find and select the WiFi network.
The WiFi network name (SSID) is on the product label.
 - b. Join the WiFi network and enter the WiFi password.
The password (network key) is on the product label.
Your computer or WiFi device connects to the modem router's WiFi network.

Note If the computer is set to a static (fixed) IP address (this setting is uncommon), either change the computer to obtain an IP address automatically from the modem router through DHCP, or change the IP address of the computer to a static IP address in the 192.168.1.2–192.168.1.254 range.

11. Launch a web browser.

The modem router checks the Internet connection.

Checking the Internet connection; please wait ...

NETGEAR genie

Configuring the Internet Connection

You are not yet connected to the Internet.

Select Country

Country: USA

Select Internet Service Provider

Internet Service Provider: AT&T

Do you want NETGEAR Genie to help?

Yes

No, I want to configure the Internet connection myself.

I have saved the router settings in a file and I want to restore the router to those settings.

Next

If the Configuring the Internet Connection page displays, skip to Step 13. If it does not display, do the following:

Install and Access the Modem Router and Its Network

Nighthawk X4S AC2600 WiFi VDSL/ADSL Modem Router Model D7800

- a. In the address field of the web browser, enter **www.routerlogin.net**.
- b. When prompted, enter **admin** for the user name and **password** for the password.

If the Configuring the Internet Connection page displays, skip to Step 13. If it still does not display, see Step 12.

12. If the browser cannot display the web page, do the following:
 - a. Make sure that the computer is connected to one of the four Ethernet LAN ports or over WiFi to the modem router.
 - b. Make sure that the Power LED  of the modem router is lit solid white.
 - c. Make sure that your browser does not cache the previous page by closing and reopening the browser.
 - d. Clear the browser cache.
 - e. If the computer is set to a static (fixed) IP address (this setting is uncommon), either change the computer to obtain an IP address automatically from the modem router through DHCP, or change the IP address of the computer to a static IP address in the 192.168.1.2–192.168.1.254 range.
13. From the **Country** menu, select the country in which you use the modem router.
14. From the **Internet Service Provider** menu, select the Internet service provider (ISP) that you are using. If your ISP is not in the menu, select **Other**.
15. Select the **Yes** radio button.
16. Click the **Next** button.

Detecting the Internet Connection

This process can take a minute or two; please wait...



When the modem router is connected to the Internet, the Congratulations! page displays, and you successfully completed the setup process. If the Congratulations! page does not display, other pages

Nighthawk X4S AC2600 WiFi VDSL/ADSL Modem Router Model D7800

might display and you might need to provide more information, in which case you must continue with the next step. The pages that display depend on your type of ISP connection and configuration.

Congratulations!

You are successfully connected to the Internet.

This router is preset with the following unique wireless network name (SSID) and [network key \(password\)](#)

2.4GHz Wireless Network Name (SSID): NETGEAR23

Wireless [Network Key \(Password\)](#) : jaggedtrumpet276

5GHz Wireless Network Name (SSID): NETGEAR23-5G

Wireless [Network Key \(Password\)](#) : jaggedtrumpet276

Print this

Take me to the Internet

17. (Only if you are using a DSL connection and the following page displays) Specify a full scan to let the Setup Wizard find the PVC protocol.

The page that might display asks you if you need the Setup Wizard to do a full scan to find the PVC protocol. If this page does not display, continue with Step 18.

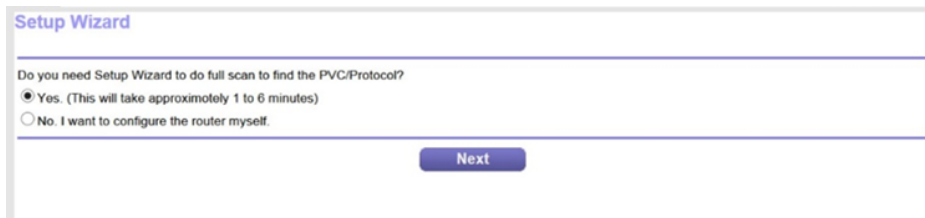

Setup Wizard

Do you need Setup Wizard to do full scan to find the PVC/Protocol?

Yes. (This will take approximately 1 to 6 minutes)

No. I want to configure the router myself.

Next

Do the following:

- a. Select the **Yes** radio button.
- b. Click the **Next** button.

The Setup Wizard performs a full scan, which might take up to six minutes.

Wizard is performing full scan of PVC/Protocol

This takes approximately 1 to 6 minutes.



18. (Only if the following page displays) Specify how to manage problems with the detection of the Internet connection.

Nighthawk X4S AC2600 WiFi VDSL/ADSL Modem Router Model D7800

The page that might display states that a problem occurred while the wizard was detecting the Internet connection. If this page does not display, continue with Step 19.

Problem Detecting the Internet Connection

This is most likely due to one of the following reasons:

1. The modem was not power cycled during the cabling step.

To solve this problem, power cycle the modem (turn it off and on). To power cycle a modem with battery backup, you might need to remove and reinsert its battery. After the power cycle, wait 2 minutes for the modem to completely start up.

2. The DSL/Ethernet cable is not fully inserted, or is inserted in the wrong place.

To solve this problem, make sure that the DSL/Ethernet cable is securely plugged in to the broadband modem port and the router Internet port.

- I just power cycled the modem and waited for 2 minutes.
- I corrected a problem with the DSL/Ethernet cable.
- None of the above.

Next

Take one of the following actions:

- If you did not yet power cycle the modem, do so now:
 - a. Unplug your modem's power, leaving the modem connected to the wall jack for your Internet service.
 - b. If your modem includes a battery backup, remove the battery.
 - c. Wait 10 seconds.
 - d. If your modem includes a battery backup, reinsert the battery.
 - e. Plug in your modem's power and turn on your modem.
 - f. Wait two minutes.
 - g. Select the **I just power cycled the modem and waited for 2 minutes** radio button.
 - h. Click the **Next** button.
- See if the DSL cable is not fully inserted or is inserted at the wrong place. If necessary, do the following:
 - a. Fully insert the DSL cable in the correct port on the modem and in the gray DSL port on the modem router.
 - b. Select the **I corrected a problem with the DSL/Ethernet cable** radio button.
 - c. Click the **Next** button.
- If you do not need to power cycle the modem or the DSL cable is already fully inserted in the correct ports, do the following:
 - a. Select the **None of the above** radio button.
 - b. Click the **Next** button.

19. (Only if the following page displays) Specify how to manage problems with the detection of the IP address for the Internet connection.

Nighthawk X4S AC2600 WiFi VDSL/ADSL Modem Router Model D7800

The page that might display states that a problem occurred while the wizard was detecting the Internet connection IP address. If this page does not display, continue with Step 20.

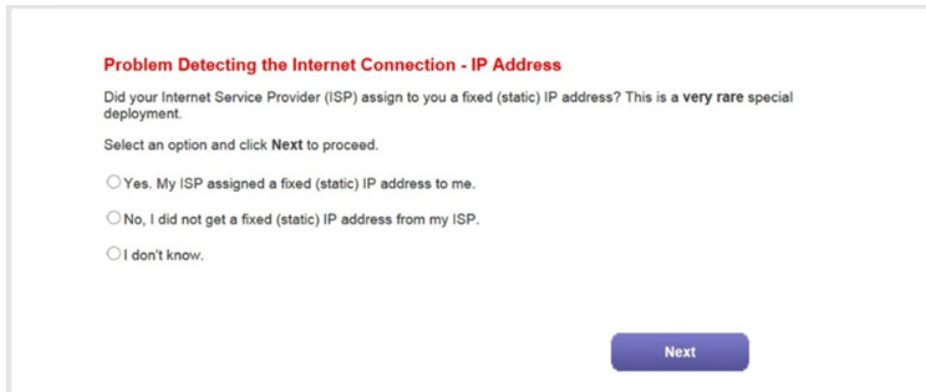

Problem Detecting the Internet Connection - IP Address

Did your Internet Service Provider (ISP) assign to you a fixed (static) IP address? This is a very rare special deployment.

Select an option and click **Next** to proceed.

Yes. My ISP assigned a fixed (static) IP address to me.

No, I did not get a fixed (static) IP address from my ISP.

I don't know.

Next

Take one of the following actions:

- If your ISP assigned you a fixed (static) IP address, do the following:
 - a. Select the **Yes** radio button.
 - b. Click the **Next** button.

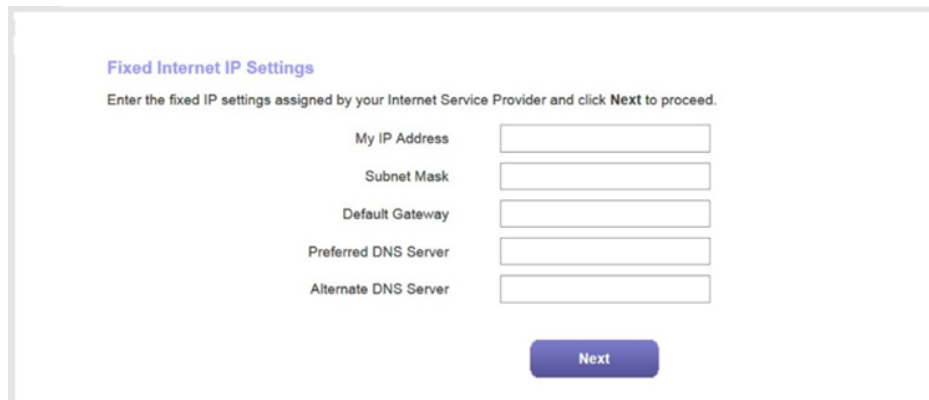

Fixed Internet IP Settings

Enter the fixed IP settings assigned by your Internet Service Provider and click **Next** to proceed.

My IP Address

Subnet Mask

Default Gateway

Preferred DNS Server

Alternate DNS Server

Next

- c. Enter the address information that your ISP gave you for your fixed IP address configuration.
 - d. Click the **Next** button.
- If your ISP did not assign you a fixed IP address or you do not know if your ISP assigned you a fixed IP address, do the following:

Nighthawk X4S AC2600 WiFi VDSL/ADSL Modem Router Model D7800

- a. Select either the **No** or the **I don't know** radio button.
- b. Click the **Next** button.

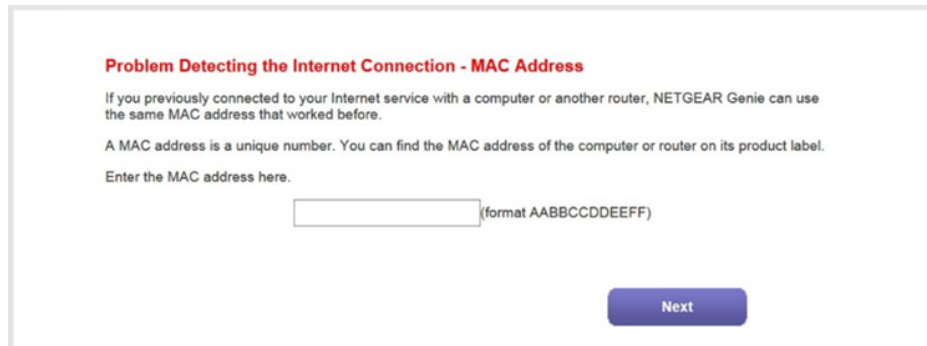

- c. Enter the MAC address of the computer or router with which you previously were able to connect to the Internet. You might find the MAC address on the product label of your device. Enter the MAC address in the AABCCDDEEFF format, not in the AA:BB:CC:DD:EE:FF format.
 - d. Click the **Next** button.
20. If the Congratulations! page still does not display and the modem router still does not connect to the Internet, do the following:
- a. Review all your settings and make sure that you selected the correct options and entered everything correctly.
 - b. Run the Setup Wizard one more time.
 - c. Contact your ISP to verify that you are using the correct configuration information.
 - d. Read *Troubleshoot the Internet Connection* on page 265.
 - e. If problems persist, register your NETGEAR product and contact NETGEAR technical support.

When the modem router connects to the Internet, you are prompted to download and install the free NETGEAR Desktop genie app and the free ReadySHARE Vault app.

Set Up the Modem Router for Cable or Fiber Service

You can install your modem router for cable or fiber (Ethernet WAN) service or for DSL service. If you use a cable or fiber modem, follow the procedure that is described in this section. If you use a DSL modem, follow the procedure that is described in *Cable the Modem Router for DSL Service and Access the Modem Router* on page 24.

The following figure shows the cabling of your modem router for cable or fiber service.

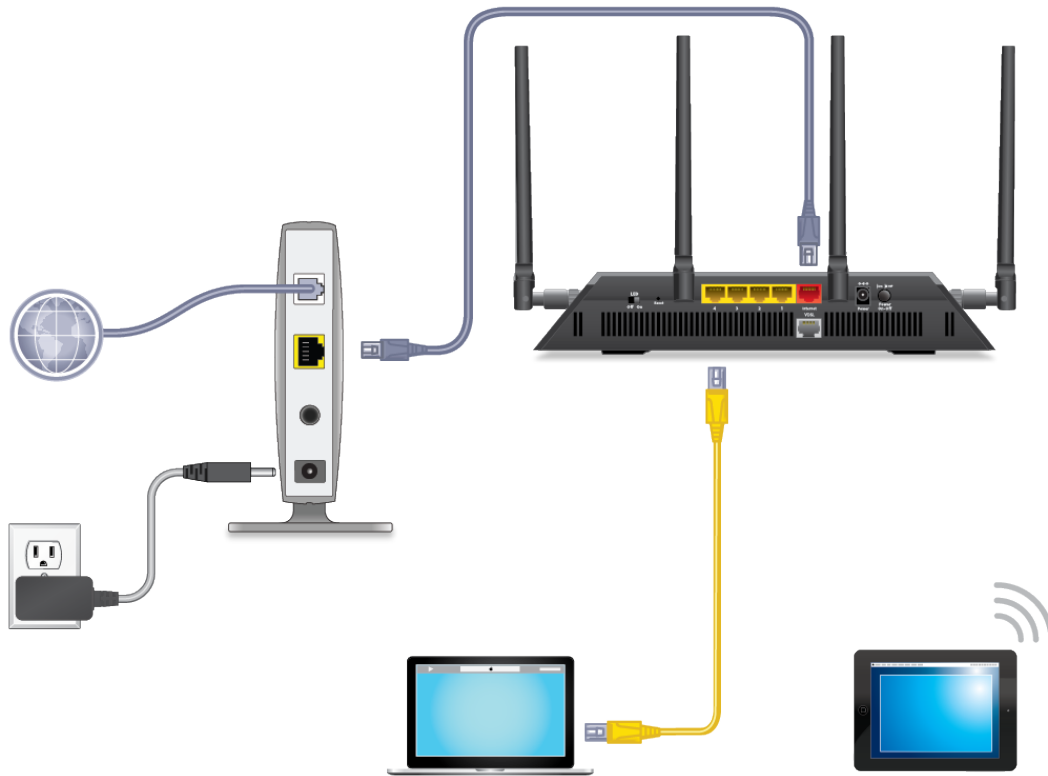





Figure 8. Modem router cabling for cable or fiber service

► **To connect your modem router to a cable or fiber service:**

1. Unplug your cable or fiber modem's power, leaving the modem connected to the wall jack for your Internet service.
2. If your cable or fiber modem includes a battery backup, remove the battery.
3. Use an Ethernet cable to connect the cable or fiber modem to the red Internet port on the modem router.
4. If your cable or fiber modem includes a battery backup, reinsert the battery.
5. Plug in and turn on your cable or fiber modem.
6. Connect the power adapter to the modem router and plug it into an electrical outlet.
Wait for the Power LED  to light solid white, which takes about two minutes.
7. If the Power LED does not light, press the **Power On/Off** button.
Wait for the WiFi LED  to light solid white.
8. If the WiFi LED does not light, press the **WiFi On/Off** button .
9. Connect a computer to the modem router by one of the following methods:
 - **Ethernet cable.** Use an Ethernet cable to connect your computer to a yellow Ethernet LAN port on the modem router.
The product package contains a yellow Ethernet cable.
Your computer connects to the modem router's LAN.
 - **WiFi.** Connect to the default WiFi network of the modem router:

Nighthawk X4S AC2600 WiFi VDSL/ADSL Modem Router Model D7800

- a. On your computer or WiFi device, find and select the WiFi network.
The WiFi network name (SSID) is on the product label.
- b. Join the WiFi network and enter the WiFi password.
The password (network key) is on the product label.
Your computer or WiFi device connects to the modem router's WiFi network.

Note If the computer is set to a static (fixed) IP address (this setting is uncommon), either change the computer to obtain an IP address automatically from the modem router through DHCP, or change the IP address of the computer to a static IP address in the 192.168.1.2–192.168.1.254 range.

10. Launch a web browser.
The modem router checks the Internet connection.

Checking the Internet connection; please wait ...

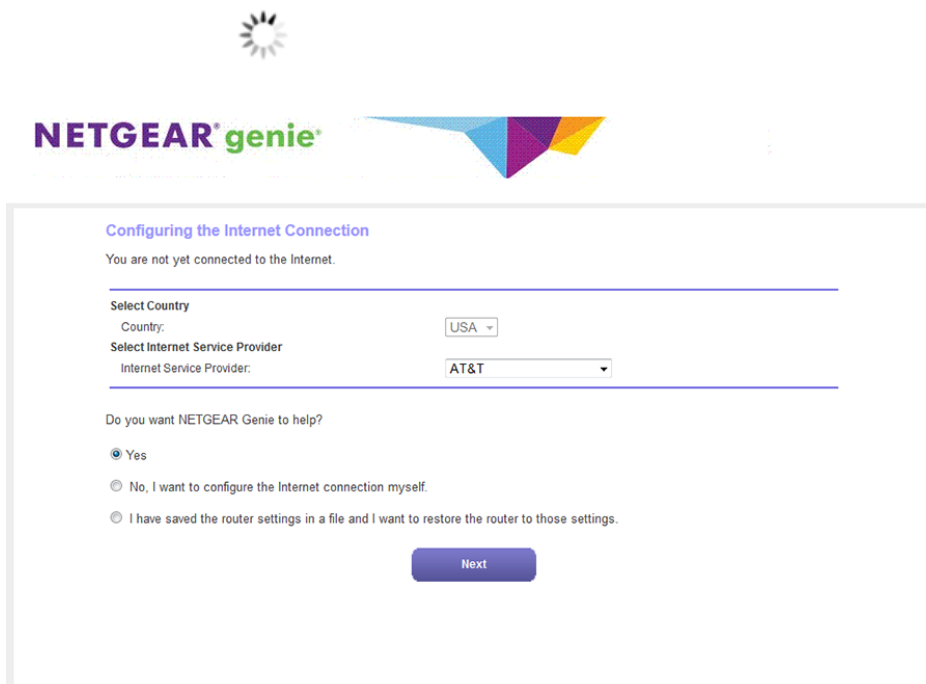

NETGEAR genie

Configuring the Internet Connection

You are not yet connected to the Internet.

Select Country
Country: USA

Select Internet Service Provider
Internet Service Provider: AT&T

Do you want NETGEAR Genie to help?

Yes

No, I want to configure the Internet connection myself.

I have saved the router settings in a file and I want to restore the router to those settings.

Next

If the Configuring the Internet Connection page displays, skip to Step 12. If it does not display, do the following:

- a. In the address field of the web browser, enter **www.routerlogin.net**.
- b. When prompted, enter **admin** for the user name and **password** for the password.

If the Configuring the Internet Connection page displays, skip to Step 12. If it still does not display, see Step 11.

Nighthawk X4S AC2600 WiFi VDSL/ADSL Modem Router Model D7800

11. If the browser cannot display the web page, do the following:
 - a. Make sure that the computer is connected to one of the four Ethernet LAN ports or over WiFi to the modem router.
 - b. Make sure that the Power LED  of the modem router is lit solid white.
 - c. Make sure that your browser does not cache the previous page by closing and reopening the browser.
 - d. Clear the browser cache.
 - e. If the computer is set to a static (fixed) IP address (this setting is uncommon), either change the computer to obtain an IP address automatically from the modem router through DHCP, or change the IP address of the computer to a static IP address in the 192.168.1.2–192.168.1.254 range.
12. From the **Country** menu, select the country in which you use the modem router.
13. From the **Internet Service Provider** menu, select the Internet service provider (ISP) that you are using. If your ISP is not in the menu, select **Other**.
14. Select the **Yes** radio button.
15. Click the **Next** button.

Detecting the Internet Connection

This process can take a minute or two; please wait...



When the modem router is connected to the Internet, the Congratulations! page displays, and you successfully completed the setup process. If the Congratulations! page does not display, other pages might display and you might need to provide more information, in which case you must continue with the next step. The pages that display depend on your type of ISP connection and configuration.

Congratulations!

You are successfully connected to the Internet.

This router is preset with the following unique wireless network name (SSID) and network key (password)

2.4GHz Wireless Network Name (SSID): NETGEAR23

Wireless Network Key (Password) : jaggedtrumpet276

5GHz Wireless Network Name (SSID): NETGEAR23-5G

Wireless Network Key (Password) : jaggedtrumpet276

Print this

Take me to the Internet

16. (Only if the following page displays) Specify how to manage problems with the detection of the Internet connection.

Nighthawk X4S AC2600 WiFi VDSL/ADSL Modem Router Model D7800

The page that might display states that a problem occurred while the wizard was detecting the Internet connection. If this page does not display, continue with Step 17.

Problem Detecting the Internet Connection

This is most likely due to one of the following reasons:

1. The modem was not power cycled during the cabling step.
To solve this problem, power cycle the modem (turn it off and on). To power cycle a modem with battery backup, you might need to remove and reinsert its battery. After the power cycle, wait 2 minutes for the modem to completely start up.
2. The DSL/Ethernet cable is not fully inserted, or is inserted in the wrong place.
To solve this problem, make sure that the DSL/Ethernet cable is securely plugged in to the broadband modem port and the router Internet port.

- I just power cycled the modem and waited for 2 minutes.
- I corrected a problem with the DSL/Ethernet cable.
- None of the above.

Next

Take one of the following actions:

- If you did not yet power cycle the modem, do so now:
 - a. Unplug your modem's power, leaving the modem connected to the wall jack for your Internet service.
 - b. If your modem includes a battery backup, remove the battery.
 - c. Wait 10 seconds.
 - d. If your modem includes a battery backup, reinsert the battery.
 - e. Plug in your modem's power and turn on your modem.
 - f. Wait two minutes.
 - g. Select the **I just power cycled the modem and waited for 2 minutes** radio button.
 - h. Click the **Next** button.
- See if the Ethernet cable is not fully inserted or is inserted at the wrong place. If necessary, do the following:
 - a. Fully insert the Ethernet cable in the correct port on the modem and in the red Internet port on the modem router.
 - b. Select the **I corrected a problem with the DSL/Ethernet cable** radio button.
 - c. Click the **Next** button.
- If you do not need to power cycle the modem or the Ethernet cable is already fully inserted in the correct ports, do the following:
 - a. Select the **None of the above** radio button.
 - b. Click the **Next** button.

17. (Only if the following page displays) Specify how to manage problems with the detection of the IP address for the Internet connection.

Nighthawk X4S AC2600 WiFi VDSL/ADSL Modem Router Model D7800

The page that might display states that a problem occurred while the wizard was detecting the Internet connection IP address. If this page does not display, continue with Step 18.

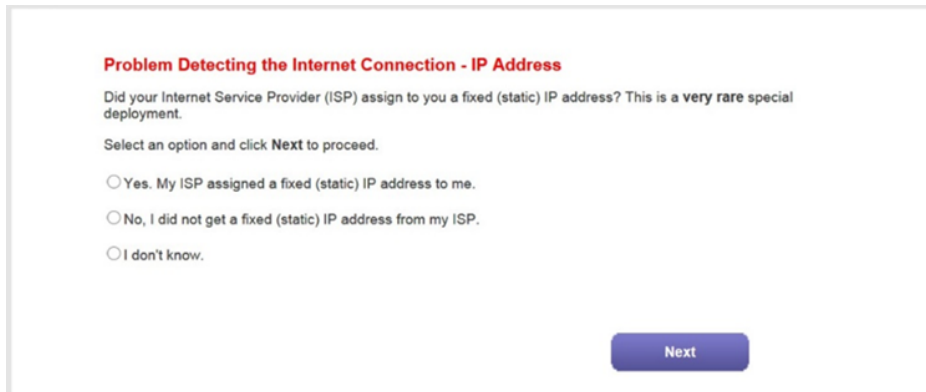

Problem Detecting the Internet Connection - IP Address

Did your Internet Service Provider (ISP) assign to you a fixed (static) IP address? This is a very rare special deployment.

Select an option and click **Next** to proceed.

Yes. My ISP assigned a fixed (static) IP address to me.

No, I did not get a fixed (static) IP address from my ISP.

I don't know.

Next

Take one of the following actions:

- If your ISP assigned you a fixed (static) IP address, do the following:
 - a. Select the **Yes** radio button.
 - b. Click the **Next** button.

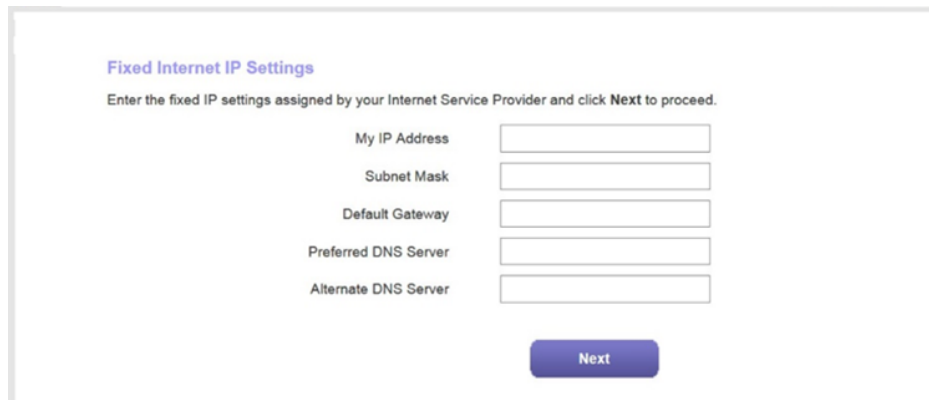

Fixed Internet IP Settings

Enter the fixed IP settings assigned by your Internet Service Provider and click **Next** to proceed.

My IP Address

Subnet Mask

Default Gateway

Preferred DNS Server

Alternate DNS Server

Next

- c. Enter the address information that your ISP gave you for your fixed IP address configuration.
 - d. Click the **Next** button.
- If your ISP did not assign you a fixed IP address or you do not know if your ISP assigned you a fixed IP address, do the following:

Nighthawk X4S AC2600 WiFi VDSL/ADSL Modem Router Model D7800

- a. Select either the **No** or the **I don't know** radio button.
- b. Click the **Next** button.

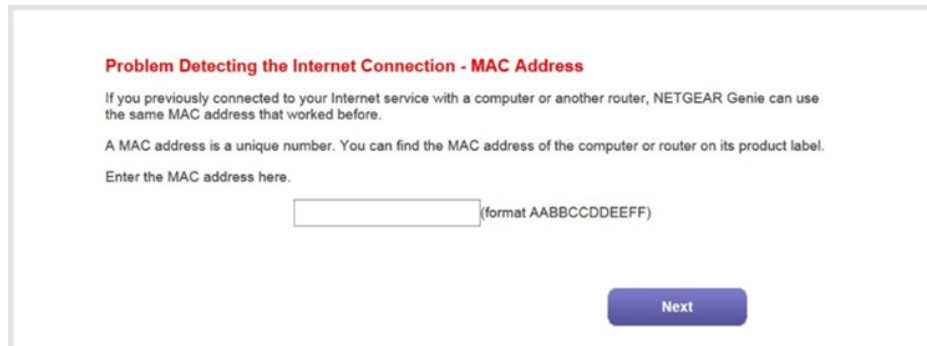

- c. Enter the MAC address of the computer or router with which you previously were able to connect to the Internet.
You might find the MAC address on the product label of your device. Enter the MAC address in the AABCCDDEEFF format, not in the AA:BB:CC:DD:EE:FF format.
 - d. Click the **Next** button.
18. If the Congratulations! page still does not display and the modem router still does not connect to the Internet, do the following:
- a. Review all your settings and make sure that you selected the correct options and entered everything correctly.
 - b. Run the Setup Wizard one more time.
 - c. Contact your ISP to verify that you are using the correct configuration information.
 - d. Read *Troubleshoot the Internet Connection* on page 265.
 - e. If problems persist, register your NETGEAR product and contact NETGEAR technical support.

When the modem router connects to the Internet, you are prompted to download and install the free NETGEAR Desktop genie app and the free ReadySHARE Vault app.

Log In to the Modem Router After Setup to View or Change Settings

After you set up the modem router for DSL, cable, or fiber service, you can view or change the settings for the modem router.

► To log in to the modem router:

1. Launch a web browser from a computer or WiFi device that is connected to the network.
2. Enter **<http://www.routerlogin.net>**.

Note You can also type **<http://www.routerlogin.com>** or **<http://192.168.1.1>**. The procedures in this manual use **<http://www.routerlogin.net>**.

Nighthawk X4S AC2600 WiFi VDSL/ADSL Modem Router Model D7800

The nature of the login window that opens depends on your web browser.

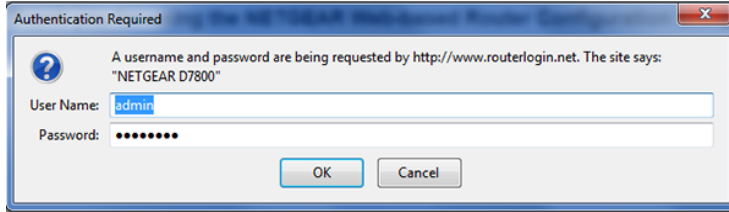

3. Enter the modem router user name and password.

The user name is **admin**. The default password is **password**. The user name and password are case-sensitive.

Click the **OK** button.



The BASIC Home page displays a dashboard that lets you see the status of your Internet connection and network at a glance. You can click any of the sections of the dashboard to view more detailed information. The left column displays the menus, and at the top is an **ADVANCED** tab that you can use to access more menus and pages.

Change the Language

By default, the language is set as Auto. You can change the language.

► To change the language:

1. Launch a web browser from a WiFi-enabled computer or mobile device that is connected to the network.
2. Enter **http://www.routerlogin.net**.

A login window opens.

3. Enter the modem router user name and password.
The user name is **admin**. The default password is **password**. The user name and password are case-sensitive.

The BASIC Home page displays.

4. In the upper right corner, select a language from the menu.
5. When prompted, click the **OK** button to confirm this change.
The page refreshes with the language that you selected.

Change the admin Password

We recommend that you change the default password that you use to log in to the modem router to a more secure password. This is the password that you use to log in to the modem router with the user name admin.

The ideal password contains no dictionary words from any language and contains uppercase and lowercase letters, numbers, and symbols. It can be up to 30 characters.

Note This admin password is not the password that you use for WiFi access. The label on your modem router shows your unique WiFi network name (SSID) and password for WiFi access.

► To change the password for the user name admin:

1. Launch a web browser from a computer or WiFi device that is connected to the network.
2. Enter **http://www.routerlogin.net**.
A login window opens.
3. Enter the modem router user name and password.
The user name is **admin**. The default password is **password**. The user name and password are case-sensitive.
The BASIC Home page displays.
4. Select **ADVANCED > Administration > Set Password**.

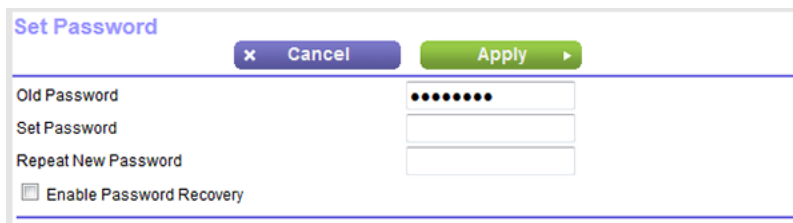

The screenshot shows a web form titled "Set Password". At the top right, there are two buttons: "Cancel" (with a close icon) and "Apply" (with a right arrow). Below the buttons are three input fields: "Old Password" (filled with dots), "Set Password", and "Repeat New Password". At the bottom left, there is a checkbox labeled "Enable Password Recovery".

5. Enter the old password.
6. Enter the new password twice.
7. Click the **Apply** button.

Your settings are saved.

Set Up Password Recovery

We recommend that you enable password recovery if you change the password for the modem router user name admin. Then you can recover the password if it is forgotten. This recovery process is supported in Internet Explorer, Firefox, and Chrome browsers, but not in the Safari browser.

► To set up password recovery:

1. Launch a web browser from a WiFi-enabled computer or mobile device that is connected to the network.
2. Enter **http://www.routerlogin.net**.
A login window opens.
3. Enter the modem router user name and password.
The user name is **admin**. The default password is **password**. The user name and password are case-sensitive.
The BASIC Home page displays.
4. Select **ADVANCED > Administration > Set Password**.
The Set Password page displays.
5. Select the **Enable Password Recovery** check box.
6. Select two security questions and provide answers to them.
7. Click the **Apply** button.
Your settings are saved.

Let the Modem Router Automatically Update Its Firmware

When you set up your modem router and are connected to the Internet, the modem router automatically checks for you to see if newer firmware is available. If it is, a message is displayed at the top of the page. For information about manually updating firmware, see [Update the Firmware of the Modem Router](#) on page 202.

► To let the modem router automatically update its firmware:

1. Launch a web browser from a WiFi-enabled computer or mobile device that is connected to the network.
2. Enter **http://www.routerlogin.net**.
A login window opens.
3. Enter the modem router user name and password.
The user name is **admin**. The default password is **password**. The user name and password are case-sensitive.
The BASIC Home page displays.
4. Wait for the modem router to determine if newer firmware is available.

Nighthawk X4S AC2600 WiFi VDSL/ADSL Modem Router Model D7800

This process might take a few minutes. If the modem router detects new firmware, the modem router displays a message at the top of the page.

5. Click the message.
6. To update the modem router with the latest firmware, click the **Yes** button.
After the update, the modem router restarts.



WARNING:

To avoid the risk of corrupting the firmware, do not interrupt the update. For example, do not close the browser, click a link, or load a new page. Do not turn off the modem router. Wait until the modem router finishes restarting and the Power LED turns solid white.

Access the Modem Router With the NETGEAR genie App

The genie app  is the easy dashboard for managing, monitoring, and repairing your home network from a smartphone, tablet, or WiFi-enabled computer. The genie app can help you with the following:

- Automatically repair common WiFi network problems.
- Easily manage modem router features such as Live Parental Controls, guest access, Internet traffic meter, speed test, and more.
- Share and stream music or videos.

▶ To use the genie app to access the modem router:

1. Visit the NETGEAR genie web page at netgear.com/genie.
2. Click the appropriate **Download** button.
3. Follow the onscreen instructions to install the app on your smartphone, tablet, or WiFi-enabled computer.
4. Launch the genie app.
The genie app dashboard displays.

Nighthawk X4S AC2600 WiFi VDSL/ADSL Modem Router Model D7800

The following figure shows the genie app dashboard for a Windows-based computer.

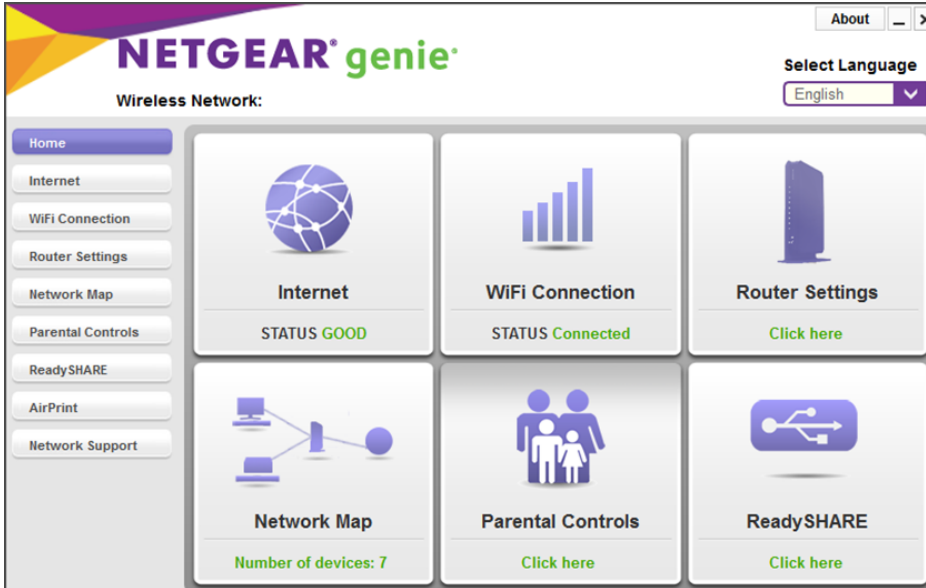

Manage the Internet Settings Manually

3

This chapter describes how you can manage the Internet settings of the modem router manually.

Usually, the quickest way to set up the modem router is to allow NETGEAR genie to detect the Internet connection when you first access the modem router with a web browser. These options are described in *Install and Access the Modem Router and Its Network* on page 19. You can also customize or specify your Internet settings manually.

The chapter contains the following sections:

- *Use the Internet Setup Wizard After Initial Setup* on page 44
- *Manually Set Up an ADSL Internet Connection* on page 49
- *Manually Set Up a VDSL Internet Connection* on page 58
- *Manually Set Up a Cable or Fiber Internet Connection* on page 66
- *Specify an IPv6 Internet Connection* on page 77
- *Manage the MTU Size* on page 90

Use the Internet Setup Wizard After Initial Setup

Whether you use DSL service or cable service, you can use the Setup Wizard to detect your Internet settings and automatically set up your modem router.

Note The Setup Wizard is the same as NETGEAR genie, which launches the first time you connect to your modem router.

► To use the Setup Wizard:

1. Launch a web browser from a computer or WiFi device that is connected to the network.
2. Enter **http://www.routerlogin.net**.
A login window opens.
3. Enter the modem router user name and password.
The user name is **admin**. The default password is **password**. The user name and password are case-sensitive.
The BASIC Home page displays.
4. Select **ADVANCED > Setup Wizard**.

Setup Wizard

Select Country
Country USA

Select Internet Service Provider
Internet Service Provider Other

Do you want NETGEAR genie to help?

Yes. I want NETGEAR genie to determine the appropriate settings for my environment and configure my router automatically.

No. I want to manually enter configuration settings using the NETGEAR genie wizard.

Saved router settings. I want to load saved router configuration settings.

Next

5. From the **Country** menu, select the country in which you use the modem router.
6. From the **Internet Service Provider** menu, select the Internet service provider (ISP) that you are using. If your ISP is not in the menu, select **Other**.
7. Select the **Yes** radio button.
If you select the **No** radio button, you are taken to the Internet Setup page after you click the **Next** button. For more information, see one of the following sections:
 - [Manually Set Up an ADSL Internet Connection](#) on page 49
 - [Manually Set Up a VDSL Internet Connection](#) on page 58
 - [Manually Set Up a Cable or Fiber Internet Connection](#) on page 66
8. Click the **Next** button.

Nighthawk X4S AC2600 WiFi VDSL/ADSL Modem Router Model D7800

The Setup Wizard searches your Internet connection for servers and protocols to determine your ISP configuration.

Detecting the Internet Connection

This process can take a minute or two; please wait...



When the modem router is connected to the Internet, the Congratulations! page displays, and you successfully completed the setup process.

If the Congratulations! page does not display, other pages might display and you might need to provide more information, in which case you must continue with the next step. The pages that display depend on your type of ISP connection and configuration.

Congratulations!

You are successfully connected to the Internet.

This router is preset with the following unique wireless network name (SSID) and network key (password)

2.4GHz Wireless Network Name (SSID): NETGEAR23

Wireless Network Key (Password) : jaggedtrumpet276

5GHz Wireless Network Name (SSID): NETGEAR23-5G

Wireless Network Key (Password) : jaggedtrumpet276

Print this

Take me to the Internet

9. (Only if you are using a DSL connection and the following page displays) Specify a full scan to let the Setup Wizard find the PVC protocol.

The page that might display asks you if you need the Setup Wizard to do a full scan to find the PVC protocol. If this page does not display, continue with Step 10.

Setup Wizard

Do you need Setup Wizard to do full scan to find the PVC/Protocol?

Yes. (This will take approximatoly 1 to 6 minutes)

No. I want to configure the router myself.

Next

Do the following:

- a. Select the **Yes** radio button.
- b. Click the **Next** button.

Nighthawk X4S AC2600 WiFi VDSL/ADSL Modem Router Model D7800

The Setup Wizard performs a full scan, which might take up to six minutes.

Wizard is performing full scan of PVC/Protocol

This takes approximately 1 to 6 minutes.



10. (Only if the following page displays) Specify how to manage problems with the detection of the Internet connection.

The page that might display states that a problem occurred while the wizard was detecting the Internet connection. If this page does not display, continue with Step 11.

Problem Detecting the Internet Connection

This is most likely due to one of the following reasons:

1. The modem was not power cycled during the cabling step.

To solve this problem, power cycle the modem (turn it off and on). To power cycle a modem with battery backup, you might need to remove and reinsert its battery. After the power cycle, wait 2 minutes for the modem to completely start up.

2. The DSL/Ethernet cable is not fully inserted, or is inserted in the wrong place.

To solve this problem, make sure that the DSL/Ethernet cable is securely plugged in to the broadband modem port and the router Internet port.

- I just power cycled the modem and waited for 2 minutes.
- I corrected a problem with the DSL/Ethernet cable.
- None of the above.

Next

Take one of the following actions:

- If you did not yet power cycle the modem, do so now:
 - a. Unplug your modem's power, leaving the modem connected to the wall jack for your Internet service.
 - b. If your modem includes a battery backup, remove the battery.
 - c. Wait 10 seconds.
 - d. If your modem includes a battery backup, reinsert the battery.
 - e. Plug in your modem's power and turn on your modem.
 - f. Wait two minutes.
 - g. Select the **I just power cycled the modem and waited for 2 minutes** radio button.
 - h. Click the **Next** button.
- See if the DSL or Ethernet cable is not fully inserted or is inserted at the wrong place. If necessary, do the following:

Nighthawk X4S AC2600 WiFi VDSL/ADSL Modem Router Model D7800

- a. Fully insert the DSL or Ethernet cable in the correct port on the modem and in the correct port on the modem router.
If you use a DSL cable, it must be connected to the gray DSL port. If you use an Ethernet cable, it must be connected to the red Internet port.
 - b. Select the **I corrected a problem with the DSL/Ethernet cable** radio button.
 - c. Click the **Next** button.
 - If you do not need to power cycle the modem or the DSL or Ethernet cable is already fully inserted in the correct ports, do the following:
 - a. Select the **None of the above** radio button.
 - b. Click the **Next** button.
11. (Only if the following page displays) Specify how to manage problems with the detection of the IP address for the Internet connection.
- The page that might display states that a problem occurred while the wizard was detecting the Internet connection IP address. If this page does not display, continue with Step 12.



Problem Detecting the Internet Connection - IP Address

Did your Internet Service Provider (ISP) assign to you a fixed (static) IP address? This is a very rare special deployment.

Select an option and click **Next** to proceed.

Yes, My ISP assigned a fixed (static) IP address to me.

No, I did not get a fixed (static) IP address from my ISP.

I don't know.

Next

Take one of the following actions:

- If your ISP assigned you a fixed (static) IP address, do the following:

Nighthawk X4S AC2600 WiFi VDSL/ADSL Modem Router Model D7800

- a. Select the **Yes** radio button.
- b. Click the **Next** button.

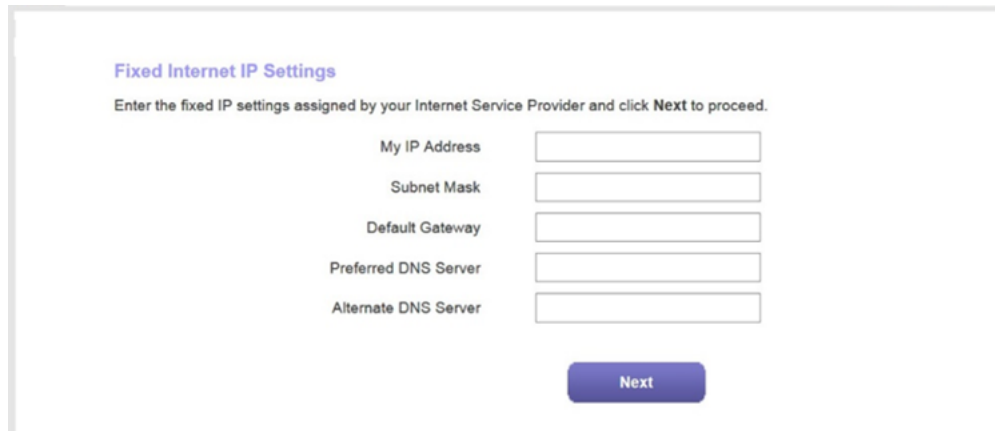

Fixed Internet IP Settings

Enter the fixed IP settings assigned by your Internet Service Provider and click **Next** to proceed.

My IP Address

Subnet Mask

Default Gateway

Preferred DNS Server

Alternate DNS Server

Next

- c. Enter the address information that your ISP gave you for your fixed IP address configuration.
 - d. Click the **Next** button.
- If your ISP did not assign you a fixed IP address or you do not know if your ISP assigned you a fixed IP address, do the following:
 - a. Select either the **No** or the **I don't know** radio button.
 - b. Click the **Next** button.

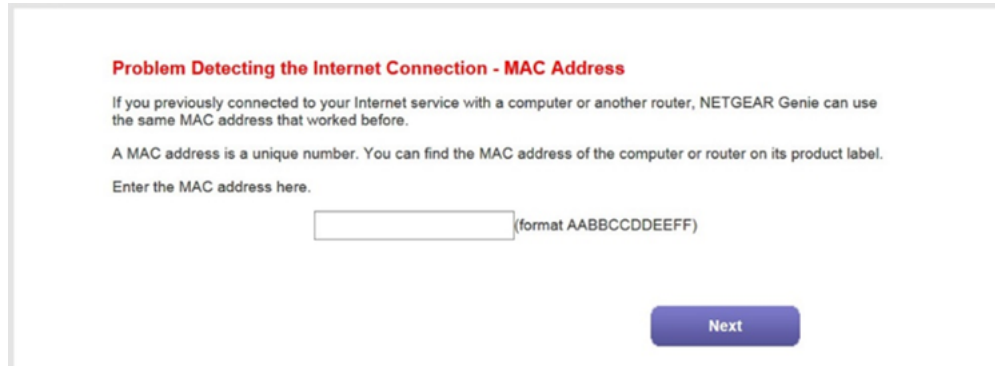

Problem Detecting the Internet Connection - MAC Address

If you previously connected to your Internet service with a computer or another router, NETGEAR Genie can use the same MAC address that worked before.

A MAC address is a unique number. You can find the MAC address of the computer or router on its product label.

Enter the MAC address here.

(format AABCCDDEEFF)

Next

- c. Enter the MAC address of the computer or router with which you previously were able to connect to the Internet.
You might find the MAC address on the product label of your device. Enter the MAC address in the AABCCDDEEFF format, not in the AA:BB:CC:DD:EE:FF format.
 - d. Click the **Next** button.
- 12.** If the Congratulations! page still does not display and the modem router still does not connect to the Internet, do the following:
- a. Review all your settings and make sure that you selected the correct options and entered everything correctly.
 - b. Run the Setup Wizard one more time.

- c. Contact your ISP to verify that you are using the correct configuration information.
- d. Read *Troubleshoot the Internet Connection* on page 265.
- e. If problems persist, register your NETGEAR product and contact NETGEAR technical support.

When the modem router connects to the Internet, you are prompted to download and install the free NETGEAR Desktop genie app and the free ReadySHARE Vault app.

Manually Set Up an ADSL Internet Connection

You can view or change the modem router's ADSL Internet connection settings manually. The following sections describe the options that are available to you to manually set up the ADSL Internet connection:

- *Specify an ADSL Connection Without a Login* on page 49
- *Specify an ADSL Connection With a Login and PPPoA or PPPoE Service* on page 54

Note Some ISPs require that you register on their website before you can obtain Internet service. Follow the directions that your ISP gave you.

Specify an ADSL Connection Without a Login

If you want to manually configure the ADSL connection settings, use the information that your ISP gave you to connect to your Internet service. If you cannot find this information, contact your ISP. Entering incorrect information might prevent the modem router from connecting to the Internet.

Note Some ISPs support two virtual interfaces: one Internet virtual interface and one IPTV virtual interface. Before you specify the settings for the IPTV interface, first use the following procedure to specify the settings for the Internet interface. Then repeat the procedure to specify the settings for the IPTV interface. While doing so, follow the directions that your ISP gave you.

► To view or specify the settings for an ADSL Internet connection that does not require a login:

1. Launch a web browser from a computer or WiFi device that is connected to the network.
2. Enter **http://www.routerlogin.net**.
A login window opens.
3. Enter the modem router user name and password.
The user name is **admin**. The default password is **password**. The user name and password are case-sensitive.
The BASIC Home page displays.
4. Select **Internet**.
The Internet Setup page displays.

Nighthawk X4S AC2600 WiFi VDSL/ADSL Modem Router Model D7800

5. From the **Select Country** menu, select the country in which you use the modem router.
The **Select Country** menu is not available in all countries and might be masked out.
6. From the **Select Internet Service Provider** menu, select the Internet service provider (ISP) that you are using.
If your ISP is not in the menu, select **Other**.
7. From the **Transfer Mode** menu, select **ADSL(ATM)**.
8. From the **DSL Mode** menu, select the ADSL mode that your ISP provided you:
 - **Auto**. The modem router detects the DSL mode automatically. (This is the default setting.)
 - **ADSL**. Legacy version of ADSL.
 - **ADSL2**. Legacy version of ADSL2.
 - **ADSL2+**. ADSL2+ provides the fastest downstream rates and can interoperate with ADSL2 and ADSL.
9. Make sure that the **Enable This Interface** check box is selected.

Note For some ISPs, you can select the IPTV virtual interface from the menu above the **Enable This Interface** check box. If you are specifying the settings for the IPTV virtual interface, select **IPTV** from the menu. However, first specify the settings for the Internet virtual interface (which is the default interface) before you specify the settings for the IPTV virtual interface.

10. Scroll down to the Does your Internet connection require a login? section and select the **No** radio button.

Nighthawk X4S AC2600 WiFi VDSL/ADSL Modem Router Model D7800

The following figure shows the settings that display when you configure an ADSL connection without a login.

The screenshot shows the 'Internet Setup' configuration page. At the top, there are buttons for 'Test', 'Cancel', and 'Apply'. The settings are as follows:

- Select Country:** USA
- Select Internet Service Provider:** Other
- Transfer Mode:** ADSL(ATM)
- DSL Mode:** Auto
- Interface:** Internet
- Enable This Interface**
- Multiplexing Method:** LLC-BASED
- VPI:** 0
- VCI:** 32
- Use VLANID**
- Priority(0-7):** 0
- Does your Internet connection require a login?**
 - Yes
 - No
- Account Name (If Required):** D7800
- Domain Name (If Required):** (empty)
- Internet IP Address:**
 - Get Dynamically from ISP
 - Use Static IP Address
 - IP Address: 0.0.0.0
 - IP Subnet Mask: 0.0.0.0
 - Gateway IP Address: 0.0.0.0
 - Use IP Over ATM (IPoA)
 - IP Address: 0.0.0.0
 - IP Subnet Mask: 0.0.0.0
 - Gateway IP Address: 0.0.0.0
- Domain Name Server (DNS) Address:**
 - Get Automatically from ISP
 - Use These DNS Servers
 - Primary DNS:
 - Secondary DNS:
 - Third DNS:
- Router MAC Address:**
 - Use Default Address
 - Use Computer MAC Address
 - Use This MAC Address: a0:63:91:7a:14:99
- DHCP Options:**
 - Vendor Class Identifier String (option 60):
 - Client Identifier String (option 61):

11. Enter the ADSL settings as described in the following table.

Nighthawk X4S AC2600 WiFi VDSL/ADSL Modem Router Model D7800

Field	Description
Multiplexing Method	Select LLC-BASED or VC-BASED , as indicated by your ISP. The multiplexing method can either be virtual circuit (VC) based or logical link control (LLC) based.
VPI	Enter a number between 0 and 255 for the virtual circuit number for the virtual path identifier (VPI), as indicated by your ISP. If your ISP did not provide you with a VPI setting, leave the default setting (8). The VPI might be required not only for a VC-based connection but also for an LLC-based connection.
VCI	Enter a number between 32 and 65535 for the virtual circuit number for the virtual channel identifier (VCI), as indicated by your ISP. If your ISP did not provide you with a VCI setting, leave the default setting (35). The VCI might be required not only for a VC-based connection but also for an LLC-based connection.
Use VLANID	Select the Use VLANID check box and enter the VLAN ID, as indicated by your ISP. A VLAN ID might be required if you subscribe to both Internet service and a service such as IPTV. If your ISP did not provide you with a VLAN ID, leave the Use VLANID check box cleared, which is the default setting.
Priority (0 ~ 7)	If your ISP provided you with a VLAN ID and a priority value, enter the priority value, which is a number from 0 to 7. You can enter a priority value only in combination with a VLAN ID. If your ISP did not provide you with a priority value, leave the default setting (0).
Bridge Mode (IPTV interface only)	If you are specifying the settings for the virtual IPTV interface and your ISP informed you that you must use bridge mode, select the Bridge Mode check box. For more information about bridge mode, see Enable Bridge Mode for IPTV Devices on page 180.
Account Name	Enter the account name, as indicated by your ISP. This name might also be called the host name. If your ISP did not provide you with an account name or host name, leave the default setting.
Domain Name	Enter the domain name, as indicated by your ISP. If your ISP did not provide you with a domain name, leave this field blank.
Internet IP Address	
Get Dynamically from ISP	Your ISP uses DHCP to assign your IP address. Your ISP automatically assigns these addresses.
Use Static IP Address	Enter the IP address, IP subnet mask, and gateway IP address that your ISP assigned you for static IP address service. The gateway is the ISP router to which your modem router connects.
Use IP over ATM (IPoA)	Enter the IP address, IP subnet mask, and gateway IP address that your ISP assigned you for IPoA service. The gateway is the ISP router to which your modem router connects.

Manage the Internet Settings Manually

(Continued)

Field	Description
Domain Name Server (DNS) Address	
The DNS server is used to look up site addresses based on their domain names.	
Get Automatically from ISP	Your ISP uses DHCP to assign your DNS servers. Your ISP automatically assigns this address.
Use These DNS Servers	If you know that your ISP does not automatically transmit DNS addresses to the modem router during login, select this option and enter the IP address of your ISP primary DNS server. If secondary and tertiary DNS server addresses are available, enter them also.
Router MAC Address	
The Ethernet MAC address that the modem router uses on the Internet port. Some ISPs register the MAC address of the network interface card in your computer when your account is first opened. They accept traffic only from the MAC address of that computer. This feature allows your modem router to use your computer's MAC address (also called cloning).	
Use Default Address	Use the default MAC address.
Use Computer MAC Address	The modem router captures and uses the MAC address of the computer that you are now using. You must use the one computer that is registered by the ISP.
Use This MAC Address	Enter the MAC address that you want to use. By default, the field displays the MAC address of the Internet port.
DHCP Options	
Vendor Class Identifier String (option 60)	Enter the vendor class identifier (VCI) string, as indicated by your ISP. If your ISP did not provide you with a VCI string, leave this field blank.
Client Identifier String (option 61)	Enter the client identifier (client ID) string, as indicated by your ISP. If your ISP did not provide you with a client ID string, leave this field blank.

12. Click the **Apply** button.
Your settings are saved.

13. Click the **Test** button to test your Internet connection.
If the NETGEAR website does not display within one minute, see [Troubleshoot the Internet Connection](#) on page 265.

Specify an ADSL Connection With a Login and PPPoA or PPPoE Service

If you want to manually configure the ADSL connection settings, use the information that your ISP gave you to log in and connect to your Internet service. If you cannot find this information, contact your ISP. Entering incorrect information might prevent the modem router from connecting to the Internet.

► **To view or specify the settings for an ADSL Internet connection that requires a login and uses a PPPoE or PPPoA service:**

1. Launch a web browser from a computer or WiFi device that is connected to the network.
2. Enter **http://www.routerlogin.net**.
A login window opens.
3. Enter the modem router user name and password.
The user name is **admin**. The default password is **password**. The user name and password are case-sensitive.
The BASIC Home page displays.
4. Select **Internet**.
The Internet Setup page displays.
5. From the **Select Country** menu, select the country in which you use the modem router.
The **Select Country** menu is not available in all countries and might be masked out.
6. From the **Select Internet Service Provider** menu, select the Internet service provider (ISP) that you are using.
If your ISP is not in the menu, select **Other**.
7. From the **Transfer Mode** menu, select **ADSL(ATM)**.
8. From the **DSL Mode** menu, select the ADSL mode that your ISP provided you:
 - **Auto**. The modem router detects the DSL mode automatically. (This is the default setting.)
 - **ADSL**. Legacy version of ADSL.
 - **ADSL2**. Legacy version of ADSL2.
 - **ADSL2+**. ADSL2+ provides the fastest downstream rates and can interoperate with ADSL2 and ADSL.
9. Make sure that the **Enable This Interface** check box is selected.
10. Scroll down to the Does your Internet connection require a login? section and select the **Yes** radio button.

Nighthawk X4S AC2600 WiFi VDSL/ADSL Modem Router Model D7800

The following figure shows the settings that display when you configure an ADSL connection with a login and PPPoE service.

The screenshot shows the 'Internet Setup' configuration page. At the top, there are three buttons: 'Test', 'Cancel', and 'Apply'. The page is divided into several sections:

- Select Country:** USA
- Select Internet Service Provider:** Other
- Transfer Mode:** ADSL(ATM)
- DSL Mode:** Auto
- Interface:** Internet
- Enable This Interface:**
- Multiplexing Method:** LLC-BASED
- VPI:** 0
- VCI:** 32
- Use VLANID:**
- Priority(0-7):** 0
- Does your Internet connection require a login?:** Yes, No
- Internet Service Provider:** PPPoE
- Login:** guest
- Password:** (empty field)
- Service Name (If Required):** (empty field)
- Connection Mode:** Always On
- Idle Timeout(In Minutes):** 5
- Internet IP Address:** Get Dynamically from ISP, Use Static IP Address. IP Address: 0.0.0.0
- Domain Name Server (DNS) Address:** Get Automatically from ISP, Use These DNS Servers. Primary DNS: (empty), Secondary DNS: (empty)
- Router MAC Address:** Use Default Address, Use Computer MAC Address, Use This MAC Address. Value: a0:63:91:7a:14:99

11. Enter the ADSL settings as described in the following table.

Nighthawk X4S AC2600 WiFi VDSL/ADSL Modem Router Model D7800

Field	Description
Multiplexing Method	Select LLC-BASED or VC-BASED , as indicated by your ISP. The multiplexing method can either be virtual circuit (VC) based or logical link control (LLC) based.
VPI	Enter a number between 0 and 255 for the virtual circuit number for the virtual path identifier (VPI), as indicated by your ISP. If your ISP did not provide you with a VPI setting, leave the default setting (8). The VPI might be required not only for a VC-based connection but also for an LLC-based connection.
VCI	Enter a number between 32 and 65535 for the virtual circuit number for the virtual channel identifier (VCI), as indicated by your ISP. If your ISP did not provide you with a VCI setting, leave the default setting (35). The VCI might be required not only for a VC-based connection but also for an LLC-based connection.
Use VLANID	Select the Use VLANID check box and enter the VLAN ID, as indicated by your ISP. A VLAN ID might be required if you subscribe to both Internet service and a service such as IPTV. If your ISP did not provide you with a VLAN ID, leave the Use VLANID check box cleared, which is the default setting.
Priority (0 ~ 7)	If your ISP provided you with a VLAN ID and a priority value, enter the priority value, which is a number from 0 to 7. You can enter a priority value only in combination with a VLAN ID. If your ISP did not provide you with a priority value, leave the default setting (0).
Internet Service Provider	Select the encapsulation, as indicated by your ISP: <ul style="list-style-type: none"> • PPPoA. Your Internet connection uses PPP over ATM. • PPPoE. Your Internet connection uses PPP over Ethernet.
Login	Enter the login name that you use to log in to your Internet service, as indicated by your ISP. This login name is often an email address.
Password	Enter the password that you use to log in to your Internet service, as indicated by your ISP.
Service Name (If Required)	Enter the service name that you use to log in to your Internet service, as indicated by your ISP. Often, a service name is not required.

Nighthawk X4S AC2600 WiFi VDSL/ADSL Modem Router Model D7800

(Continued)

Field	Description
Connection Mode	<p>Select how the Internet connection functions:</p> <ul style="list-style-type: none"> • Always On. Once the Internet connection is established, it remains active. This is the default setting. • Dial on Demand. When someone attempts to connect to the Internet, the Internet connection is established. When the idle time-out period expires, the Internet connection is terminated. • Manually Connect. You must connect to the Internet manually (see View, Establish, or Terminate the PPPoE or PPPoA Internet Connection on page 216).
Idle Timeout (In Minutes)	<p>If you select Dial on Demand from the Connection Mode menu, enter the idle time-out period in minutes.</p> <p>The idle time-out specifies how long the modem router keeps the Internet connection active when no one on the network is using the Internet connection. The default is 5 minutes. To disable the idle time-out, enter 0. (When you disable the idle time-out, the connection is not terminated automatically.)</p>
Internet IP Address	
Get Dynamically from ISP	Your ISP uses DHCP to assign your IP address. Your ISP automatically assigns these addresses.
Use Static IP Address	Enter the IP address, IP subnet mask, and gateway IP address that your ISP assigned you for static IP address service. The gateway is the ISP router to which your modem router connects.
Domain Name Server (DNS) Address	
The DNS server is used to look up site addresses based on their domain names.	
Get Automatically from ISP	Your ISP uses DHCP to assign your DNS servers. Your ISP automatically assigns this address.
Use These DNS Servers	If you know that your ISP does not automatically transmit DNS addresses to the modem router during login, select this option and enter the IP address of your ISP primary DNS server. If a secondary DNS server address is available, enter it also.
Router MAC Address	
<p>The Ethernet MAC address that the modem router uses on the Internet port. Some ISPs register the MAC address of the network interface card in your computer when your account is first opened. They accept traffic only from the MAC address of that computer.</p> <p>This feature allows your modem router to use your computer's MAC address (also called cloning).</p>	
Use Default Address	Use the default MAC address.

(Continued)

Field	Description
Use Computer MAC Address	The modem router captures and uses the MAC address of the computer that you are now using. You must use the one computer that is registered by the ISP.
Use This MAC Address	Enter the MAC address that you want to use. By default, the field displays the MAC address of the Internet port.

12. Click the **Apply** button.

Your settings are saved.

13. Click the **Test** button to test your Internet connection.

If the NETGEAR website does not display within one minute, see *Troubleshoot the Internet Connection* on page 265.

Manually Set Up a VDSL Internet Connection

You can view or change the modem router's VDSL Internet connection settings manually. The following sections describe the options that are available to you to manually set up the VDSL Internet connection:

- *Specify a VDSL Connection Without a Login* on page 58
- *Specify a VDSL Connection With a Login and PPPoE Service* on page 62

Note Some ISPs require that you register on their website before you can obtain Internet service. Follow the directions that your ISP gave you.

Specify a VDSL Connection Without a Login

If you want to manually configure the VDSL connection settings, use the information that your ISP gave you to connect to your Internet service. If you cannot find this information, contact your ISP. Entering incorrect information might prevent the modem router from connecting to the Internet.

Note Some ISPs support two virtual interfaces: one Internet virtual interface and one IPTV virtual interface. Before you specify the settings for the IPTV interface, first use the following procedure to specify the settings for the Internet interface. Then repeat the procedure to specify the settings for the IPTV interface. While doing so, follow the directions that your ISP gave you.

► **To view or specify the settings for a VDSL Internet connection that does not require a login:**

1. Launch a web browser from a computer or WiFi device that is connected to the network.
2. Enter **http://www.routerlogin.net**.

Nighthawk X4S AC2600 WiFi VDSL/ADSL Modem Router Model D7800

A login window opens.

3. Enter the modem router user name and password.
The user name is **admin**. The default password is **password**. The user name and password are case-sensitive.
The BASIC Home page displays.
4. Select **Internet**.
The Internet Setup page displays.
5. From the **Select Country** menu, select the country in which you use the modem router.
The **Select Country** menu is not available in all countries and might be masked out.
6. From the **Select Internet Service Provider** menu, select the Internet service provider (ISP) that you are using.
If your ISP is not in the menu, select **Other**.
7. From the **Transfer Mode** menu, select **VDSL(PTM)**.
When you select **VDSL(PTM)** from the **Transfer Mode** menu, the only option in the **DSL Mode** menu is **VDSL2**.
8. Make sure that the **Enable This Interface** check box is selected.

Note For some ISPs, you can select the IPTV virtual interface from the menu above the **Enable This Interface** check box. If you are specifying the settings for the IPTV virtual interface, select **IPTV** from the menu. However, first specify the settings for the Internet virtual interface (which is the default interface) before you specify the settings for the IPTV virtual interface.

9. Scroll down to the Does your Internet connection require a login? section and select the **No** radio button.

Nighthawk X4S AC2600 WiFi VDSL/ADSL Modem Router Model D7800

The following figure shows the settings that display when you configure a VDSL connection without a login.

The screenshot shows the 'Internet Setup' configuration page. At the top, there are buttons for 'Test', 'Cancel', and 'Apply'. The settings are as follows:

- Select Country:** USA
- Select Internet Service Provider:** Other
- Transfer Mode:** VDSL(PTM)
- DSL Mode:** VDSL2
- Internet:** Internet (dropdown)
- Enable This Interface:**
- Multiplexing Method:** LLC-BASED
- VPI:** 8
- VCI:** 35
- Use VLANID:**
- Priority(0-7):** 0
- Does your Internet connection require a login?:** No
- Account Name (If Required):** D7800
- Domain Name (If Required):** (empty)
- Internet IP Address:** Get Dynamically from ISP
- IP Address:** 0.0.0.0
- IP Subnet Mask:** 0.0.0.0
- Gateway IP Address:** 0.0.0.0
- Use IP Over ATM (IPoA):**
- IP Address:** 0.0.0.0
- IP Subnet Mask:** 0.0.0.0
- Gateway IP Address:** 0.0.0.0
- Domain Name Server (DNS) Address:** Get Automatically from ISP
- Use These DNS Servers:**
- Primary DNS:** (empty)
- Secondary DNS:** (empty)
- Third DNS:** (empty)
- Router MAC Address:** Use Default Address
- Use Computer MAC Address:**
- Use This MAC Address:** a0:63:91:7a:14:99
- DHCP Options:**
- Vendor Class Identifier String (option 60):** (empty)
- Client Identifier String (option 61):** (empty)

10. Enter the VDSL settings as described in the following table.

Nighthawk X4S AC2600 WiFi VDSL/ADSL Modem Router Model D7800

Field	Description
Multiplexing Method	These settings are disabled because they do not apply to a VDSL connection.
VPI	
VCI	
Use VLANID	Select the Use VLANID check box and enter the VLAN ID, as indicated by your ISP. A VLAN ID might be required if you subscribe to both Internet service and a service such as IPTV. If your ISP did not provide you with a VLAN ID, leave the Use VLANID check box cleared, which is the default setting.
Priority (0 ~ 7)	If your ISP provided you with a VLAN ID and a priority value, enter the priority value, which is a number from 0 to 7. You can enter a priority value only in combination with a VLAN ID. If your ISP did not provide you with a priority value, leave the default setting (0).
Bridge Mode (IPTV interface only)	If you are specifying the settings for the virtual IPTV interface and your ISP informed you that you must use bridge mode, select the Bridge Mode check box. For more information about bridge mode, see Enable Bridge Mode for IPTV Devices on page 180.
Account Name	Enter the account name, as indicated by your ISP. This name might also be called the host name. If your ISP did not provide you with an account name or host name, leave the default setting.
Domain Name	Enter the domain name, as indicated by your ISP. If your ISP did not provide you with a domain name, leave this field blank.
Internet IP Address	
Get Dynamically from ISP	Your ISP uses DHCP to assign your IP address. Your ISP automatically assigns these addresses.
Use Static IP Address	Enter the IP address, IP subnet mask, and gateway IP address that your ISP assigned you for static IP address service. The gateway is the ISP router to which your modem router connects.
Use IP over ATM (IPoA)	Enter the IP address, IP subnet mask, and gateway IP address that your ISP assigned you for IPoA service. The gateway is the ISP router to which your modem router connects.
Domain Name Server (DNS) Address	
The DNS server is used to look up site addresses based on their domain names.	
Get Automatically from ISP	Your ISP uses DHCP to assign your DNS servers. Your ISP automatically assigns this address.
Use These DNS Servers	If you know that your ISP does not automatically transmit DNS addresses to the modem router during login, select this option and enter the IP address of your ISP primary DNS server. If secondary and tertiary DNS server addresses are available, enter them also.

Manage the Internet Settings Manually

(Continued)

Field	Description
Router MAC Address	
The Ethernet MAC address that the modem router uses on the Internet port. Some ISPs register the MAC address of the network interface card in your computer when your account is first opened. They accept traffic only from the MAC address of that computer. This feature allows your modem router to use your computer's MAC address (also called cloning).	
Use Default Address	Use the default MAC address.
Use Computer MAC Address	The modem router captures and uses the MAC address of the computer that you are now using. You must use the one computer that is registered by the ISP.
Use This MAC Address	Enter the MAC address that you want to use. By default, the field displays the MAC address of the Internet port.
DHCP Options	
Vendor Class Identifier String (option 60)	Enter the vendor class identifier (VCI) string, as indicated by your ISP. If your ISP did not provide you with a VCI string, leave this field blank.
Client Identifier String (option 61)	Enter the client identifier (client ID) string, as indicated by your ISP. If your ISP did not provide you with a client ID string, leave this field blank.

11. Click the **Apply** button.

Your settings are saved.

12. Click the **Test** button to test your Internet connection.

If the NETGEAR website does not display within one minute, see [Troubleshoot the Internet Connection](#) on page 265.

Specify a VDSL Connection With a Login and PPPoE Service

If you want to manually configure the VDSL connection settings, use the information that your ISP gave you to log in and connect to your Internet service. If you cannot find this information, contact your ISP. Entering incorrect information might prevent the modem router from connecting to the Internet.

- ▶ **To view or specify the settings for a VDSL Internet connection that requires a login and uses a PPPoE service:**

1. Launch a web browser from a computer or WiFi device that is connected to the network.
2. Enter **http://www.routerlogin.net**.
A login window opens.
3. Enter the modem router user name and password.

Nighthawk X4S AC2600 WiFi VDSL/ADSL Modem Router Model D7800

The user name is **admin**. The default password is **password**. The user name and password are case-sensitive.

The BASIC Home page displays.

4. Select **Internet**.

The Internet Setup page displays.

5. From the **Select Country** menu, select the country in which you use the modem router.

The **Select Country** menu is not available in all countries and might be masked out.

6. From the **Select Internet Service Provider** menu, select the Internet service provider (ISP) that you are using.

If your ISP is not in the menu, select **Other**.

7. From the **Transfer Mode** menu, select **VDSL(PTM)**.

When you select **VDSL(PTM)** from the **Transfer Mode** menu, the only option in the **DSL Mode** menu is **VDSL2**.

8. Make sure that the **Enable This Interface** check box is selected.

9. Scroll down to the Does your Internet connection require a login? section and select the **Yes** radio button.

Nighthawk X4S AC2600 WiFi VDSL/ADSL Modem Router Model D7800

The following figure shows the settings that display when you configure a VDSL connection with a login and PPPoE service.

The screenshot displays the 'Internet Setup' configuration page. At the top, there are buttons for 'Test', 'Cancel', and 'Apply'. The settings are organized into several sections:

- Select Country:** USA
- Select Internet Service Provider:** Other
- Transfer Mode:** VDSL(PTM)
- DSL Mode:** VDSL2
- Interface:** Internet
- Enable This Interface:**
- Multiplexing Method:** LLC-BASED
- VPI:** 8
- VCI:** 35
- Use VLANID:**
- Priority(0-7):** 0
- Does your Internet connection require a login?:** Yes, No
- Internet Service Provider:** PPPoE
- Login:** guest
- Password:** (empty field)
- Service Name (If Required):** (empty field)
- Connection Mode:** Always On
- Idle Timeout(In Minutes):** 5
- Internet IP Address:** Get Dynamically from ISP, Use Static IP Address. IP Address: 0.0.0.0
- Domain Name Server (DNS) Address:** Get Automatically from ISP, Use These DNS Servers. Primary DNS: Secondary DNS:
- Router MAC Address:** Use Default Address, Use Computer MAC Address, Use This MAC Address. Value: a0:63:91:7a:14:99

10. Enter the VDSL settings as described in the following table.

Nighthawk X4S AC2600 WiFi VDSL/ADSL Modem Router Model D7800

Field	Description
Multiplexing Method	These settings are disabled because they do not apply to a VDSL connection.
VPI	
VCI	
Use VLANID	<p>Select the Use VLANID check box and enter the VLAN ID, as indicated by your ISP.</p> <p>A VLAN ID might be required if you subscribe to both Internet service and a service such as IPTV. If your ISP did not provide you with a VLAN ID, leave the Use VLANID check box cleared, which is the default setting.</p>
Priority (0 ~ 7)	<p>If your ISP provided you with a VLAN ID and a priority value, enter the priority value, which is a number from 0 to 7.</p> <p>You can enter a priority value only in combination with a VLAN ID. If your ISP did not provide you with a priority value, leave the default setting (0).</p>
Internet Service Provider	<p>By default, the menu selection is PPPoE for a PPP over Ethernet VDSL connection.</p> <p>The VDSL connection does not support PPP over ATM (PPPoA).</p>
Login	<p>Enter the login name that you use to log in to your Internet service, as indicated by your ISP.</p> <p>This login name is often an email address.</p>
Password	Enter the password that you use to log in to your Internet service, as indicated by your ISP.
Service Name (If Required)	<p>Enter the service name that you use to log in to your Internet service, as indicated by your ISP.</p> <p>Often, a service name is not required.</p>
Connection Mode	<p>Select how the Internet connection functions:</p> <ul style="list-style-type: none"> • Always On. Once the Internet connection is established, it remains active. This is the default setting. • Dial on Demand. When someone attempts to connect to the Internet, the Internet connection is established. When the idle time-out period expires, the Internet connection is terminated. • Manually Connect. You must connect to the Internet manually (see View, Establish, or Terminate the PPPoE or PPPoA Internet Connection on page 216).
Idle Timeout (In Minutes)	<p>If you select Dial on Demand from the Connection Mode menu, enter the idle time-out period in minutes.</p> <p>The idle time-out specifies how long the modem router keeps the Internet connection active when no one on the network is using the Internet connection. The default is 5 minutes. To disable the idle time-out, enter 0. (When you disable the idle time-out, the connection is not terminated automatically).</p>

Manage the Internet Settings Manually

(Continued)

Field	Description
Internet IP Address	
Get Dynamically from ISP	Your ISP uses DHCP to assign your IP address. Your ISP automatically assigns these addresses.
Use Static IP Address	Enter the IP address, IP subnet mask, and gateway IP address that your ISP assigned you for static IP address service. The gateway is the ISP router to which your modem router connects.
Domain Name Server (DNS) Address	
The DNS server is used to look up site addresses based on their domain names.	
Get Automatically from ISP	Your ISP uses DHCP to assign your DNS servers. Your ISP automatically assigns this address.
Use These DNS Servers	If you know that your ISP does not automatically transmit DNS addresses to the modem router during login, select this option and enter the IP address of your ISP primary DNS server. If a secondary DNS server address is available, enter it also.
Router MAC Address	
The Ethernet MAC address that the modem router uses on the Internet port. Some ISPs register the MAC address of the network interface card in your computer when your account is first opened. They accept traffic only from the MAC address of that computer. This feature allows your modem router to use your computer's MAC address (also called cloning).	
Use Default Address	Use the default MAC address.
Use Computer MAC Address	The modem router captures and uses the MAC address of the computer that you are now using. You must use the one computer that is registered by the ISP.
Use This MAC Address	Enter the MAC address that you want to use. By default, the field displays the MAC address of the Internet port.

11. Click the **Apply** button.
Your settings are saved.

12. Click the **Test** button to test your Internet connection.
If the NETGEAR website does not display within one minute, see [Troubleshoot the Internet Connection](#) on page 265.

Manually Set Up a Cable or Fiber Internet Connection

You can view or change the modem router's cable or fiber Internet connection settings manually. The following sections describe the options that are available to you to manually set up the cable or fiber Internet connection:

Manage the Internet Settings Manually

- *Specify a Cable or Fiber Connection Without a Login* on page 67
- *Specify a Cable or Fiber Connection With a Login and PPPoE Service* on page 70
- *Specify a Cable or Fiber Connection With a Login and PPTP or L2TP Service* on page 74

Note Some ISPs require that you register on their website before you can obtain Internet service. Follow the directions that your ISP gave you.

Specify a Cable or Fiber Connection Without a Login

If you want to manually configure the cable or fiber connection settings, use the information that your ISP gave you to connect to your Internet service. If you cannot find this information, contact your ISP. Entering incorrect information might prevent the modem router from connecting to the Internet.

► To view or specify the settings for a cable or fiber Internet connection that does not require a login:

1. Launch a web browser from a computer or WiFi device that is connected to the network.
2. Enter **http://www.routerlogin.net**.
A login window opens.
3. Enter the modem router user name and password.
The user name is **admin**. The default password is **password**. The user name and password are case-sensitive.
The BASIC Home page displays.
4. Select **ADVANCED > Setup > WAN Setup**.
The WAN Setup page displays.
5. From the **WAN Preference** menu, select **Must use Ethernet WAN**.
By default, the menu selection is **Must use DSL WAN**.
6. Click the **Apply** button.
Your settings are saved and the modem router restarts.

Note If you use a WiFi device to connect to the modem router, you might need to log in again.

7. Select **BASIC > Internet**.
The Internet Setup page displays.
8. From the **Select Country** menu, select the country in which you use the modem router.
The **Select Country** menu is not available in all countries and might be masked out.
9. From the **Select Internet Service Provider** menu, select the Internet service provider (ISP) that you are using.
If your ISP is not in the menu, select **Other**.

Nighthawk X4S AC2600 WiFi VDSL/ADSL Modem Router Model D7800

10. Make sure that the **Enable This Interface** check box is selected.
11. Scroll down to the Does your Internet connection require a login? section and select the **No** radio button. The following figure shows the settings that display when you configure a cable or fiber connection without a login.

The screenshot displays the 'Internet Setup' configuration page. At the top, there are 'Test', 'Cancel', and 'Apply' buttons. The 'Select Country' dropdown is set to 'USA' and 'Select Internet Service Provider' is set to 'Other'. Below these, there is a section for 'Internet' with a dropdown menu and a checked 'Enable This Interface' checkbox. Further down, there is an unchecked 'Use VLANID' checkbox and a 'Priority(0-7)' field set to '0'. The 'Does your Internet connection require a login?' section has the 'No' radio button selected. The 'Account Name (If Required)' field contains 'D7800' and the 'Domain Name (If Required)' field is empty. The 'Internet IP Address' section has 'Get Dynamically from ISP' selected, with fields for IP Address, IP Subnet Mask, and Gateway IP Address, all set to '0'. The 'Use IP Over ATM (IPoA)' section has similar fields, also set to '0'. The 'Domain Name Server (DNS) Address' section has 'Get Automatically from ISP' selected, with fields for Primary, Secondary, and Third DNS, all empty. The 'Router MAC Address' section has 'Use Default Address' selected, with 'Use This MAC Address' set to 'a0:63:91:7a:14:99'. Finally, the 'DHCP Options' section has fields for 'Vendor Class Identifier String (option 60)' and 'Client Identifier String (option 61)', both empty.

12. Enter the cable or fiber settings as described in the following table.

Nighthawk X4S AC2600 WiFi VDSL/ADSL Modem Router Model D7800

Field	Description
Use VLANID	<p>Select the Use VLANID check box and enter the VLAN ID, as indicated by your ISP.</p> <p>A VLAN ID might be required if you subscribe to both Internet service and a service such as IPTV. If your ISP did not provide you with a VLAN ID, leave the Use VLANID check box cleared, which is the default setting.</p>
Priority (0 ~ 7)	<p>If your ISP provided you with a VLAN ID and a priority value, enter the priority value, which is a number from 0 to 7.</p> <p>You can enter a priority value only in combination with a VLAN ID. If your ISP did not provide you with a priority value, leave the default setting (0).</p>
Account Name	<p>Enter the account name, as indicated by your ISP. This name might also be called the host name.</p> <p>If your ISP did not provide you with an account name or host name, leave the default setting.</p>
Domain Name	<p>Enter the domain name, as indicated by your ISP.</p> <p>If your ISP did not provide you with a domain name, leave this field blank.</p>
Internet IP Address	
Get Dynamically from ISP	Your ISP uses DHCP to assign your IP address. Your ISP automatically assigns these addresses.
Use Static IP Address	Enter the IP address, IP subnet mask, and gateway IP address that your ISP assigned you for static IP address service. The gateway is the ISP router to which your modem router connects.
Use IP over ATM (IPoA)	Enter the IP address, IP subnet mask, and gateway IP address that your ISP assigned you for IPoA service. The gateway is the ISP router to which your modem router connects.
Domain Name Server (DNS) Address	
The DNS server is used to look up site addresses based on their domain names.	
Get Automatically from ISP	Your ISP uses DHCP to assign your DNS servers. Your ISP automatically assigns this address.
Use These DNS Servers	If you know that your ISP does not automatically transmit DNS addresses to the modem router during login, select this option and enter the IP address of your ISP primary DNS server. If secondary and tertiary DNS server addresses are available, enter them also.
Router MAC Address	
<p>The Ethernet MAC address that the modem router uses on the Internet port. Some ISPs register the MAC address of the network interface card in your computer when your account is first opened. They accept traffic only from the MAC address of that computer.</p> <p>This feature allows your modem router to use your computer's MAC address (also called cloning).</p>	
Use Default Address	Use the default MAC address.

(Continued)

Field	Description
Use Computer MAC Address	The modem router captures and uses the MAC address of the computer that you are now using. You must use the one computer that is registered by the ISP.
Use This MAC Address	Enter the MAC address that you want to use. By default, the field displays the MAC address of the Internet port.
DHCP Options	
Vendor Class Identifier String (option 60)	Enter the vendor class identifier (VCI) string, as indicated by your ISP. If your ISP did not provide you with a VCI string, leave this field blank.
Client Identifier String (option 61)	Enter the client identifier (client ID) string, as indicated by your ISP. If your ISP did not provide you with a client ID string, leave this field blank.

13. Click the **Apply** button.

Your settings are saved.

14. Click the **Test** button to test your Internet connection.

If the NETGEAR website does not display within one minute, see [Troubleshoot the Internet Connection](#) on page 265.

Specify a Cable or Fiber Connection With a Login and PPPoE Service

If you want to manually configure the cable or fiber connection settings, use the information that your ISP gave you to connect to your Internet service. If you cannot find this information, contact your ISP. Entering incorrect information might prevent the modem router from connecting to the Internet.

- ▶ **To view or specify the settings for a cable or fiber Internet connection that requires a login and uses a PPPoE service:**

1. Launch a web browser from a computer or WiFi device that is connected to the network.
2. Enter **http://www.routerlogin.net**.
A login window opens.
3. Enter the modem router user name and password.
The user name is **admin**. The default password is **password**. The user name and password are case-sensitive.
The BASIC Home page displays.
4. Select **ADVANCED > Setup > WAN Setup**.
The WAN Setup page displays.

Nighthawk X4S AC2600 WiFi VDSL/ADSL Modem Router Model D7800

5. From the **WAN Preference** menu, select **Must use Ethernet WAN**.

By default, the menu selection is **Must use DSL WAN**.

6. Click the **Apply** button.

Your settings are saved and the modem router restarts.

Note If you use a WiFi device to connect to the modem router, you might need to log in again.

7. Select **BASIC > Internet**.

The Internet Setup page displays.

8. From the **Select Country** menu, select the country in which you use the modem router.

The **Select Country** menu is not available in all countries and might be masked out.

9. From the **Select Internet Service Provider** menu, select the Internet service provider (ISP) that you are using.

If your ISP is not in the menu, select **Other**.

10. Make sure that the **Enable This Interface** check box is selected.

11. Scroll down to the Does your Internet connection require a login? section and select the **Yes** radio button.

Nighthawk X4S AC2600 WiFi VDSL/ADSL Modem Router Model D7800

The following figure shows the settings that display when you configure a cable or fiber connection with a login and PPPoE service.

The screenshot shows the 'Internet Setup' configuration page. At the top, there are buttons for 'Test', 'Cancel', and 'Apply'. The settings are as follows:

- Select Country:** USA
- Select Internet Service Provider:** Other
- Internet:** Internet
- Enable This Interface:**
- Use VLANID:** (with a text input field)
- Priority(0~7):** 0
- Does your Internet connection require a login?:** Yes, No
- Internet Service Provider:** PPPoE
- Login:** guest
- Password:** (empty text input)
- Service Name (If Required):** (empty text input)
- Connection Mode:** Always On
- Idle Timeout(In Minutes):** 5
- Internet IP Address:** Get Dynamically from ISP, Use Static IP Address (with IP Address input fields: 0, 0, 0, 0)
- Domain Name Server (DNS) Address:** Get Automatically from ISP, Use These DNS Servers (with Primary and Secondary DNS input fields)
- Router MAC Address:** Use Default Address, Use Computer MAC Address, Use This MAC Address (with text input field: a0:63:91:7a:14:99)

12. Enter the cable or fiber settings as described in the following table.

Field	Description
Use VLANID	Select the Use VLANID check box and enter the VLAN ID, as indicated by your ISP. A VLAN ID might be required if you subscribe to both Internet service and a service such as IPTV. If your ISP did not provide you with a VLAN ID, leave the Use VLANID check box cleared, which is the default setting.
Priority (0 ~ 7)	If your ISP provided you with a VLAN ID and a priority value, enter the priority value, which is a number from 0 to 7. You can enter a priority value only in combination with a VLAN ID. If your ISP did not provide you with a priority value, leave the default setting (0).
Internet Service Provider	From the menu, select PPPoE for a PPP over Ethernet connection.

Nighthawk X4S AC2600 WiFi VDSL/ADSL Modem Router Model D7800

(Continued)

Field	Description
Login	Enter the login name that you use to log in to your Internet service, as indicated by your ISP. This login name is often an email address.
Password	Enter the password that you use to log in to your Internet service, as indicated by your ISP.
Service Name (If Required)	Enter the service name that you use to log in to your Internet service, as indicated by your ISP. Often, a service name is not required.
Connection Mode	Select how the Internet connection functions: <ul style="list-style-type: none"> • Always On. Once the Internet connection is established, it remains active. This is the default setting. • Dial on Demand. When someone attempts to connect to the Internet, the Internet connection is established. When the idle time-out period expires, the Internet connection is terminated. • Manually Connect. You must connect to the Internet manually (see View, Establish, or Terminate the PPPoE or PPPoA Internet Connection on page 216).
Idle Timeout (In Minutes)	If you select Dial on Demand from the Connection Mode menu, enter the idle time-out period in minutes. The idle time-out specifies how long the modem router keeps the Internet connection active when no one on the network is using the Internet connection. The default is 5 minutes. To disable the idle time-out, enter 0 . (When you disable the idle time-out, the connection is not terminated automatically.)
Internet IP Address	
Get Dynamically from ISP	Your ISP uses DHCP to assign your IP address. Your ISP automatically assigns these addresses.
Use Static IP Address	Enter the IP address, IP subnet mask, and gateway IP address that your ISP assigned you for static IP address service. The gateway is the ISP router to which your modem router connects.
Domain Name Server (DNS) Address	
The DNS server is used to look up site addresses based on their domain names.	
Get Automatically from ISP	Your ISP uses DHCP to assign your DNS servers. Your ISP automatically assigns this address.
Use These DNS Servers	If you know that your ISP does not automatically transmit DNS addresses to the modem router during login, select this option and enter the IP address of your ISP primary DNS server. If a secondary DNS server address is available, enter it also.

Manage the Internet Settings Manually

(Continued)

Field	Description
Router MAC Address	
The Ethernet MAC address that the modem router uses on the Internet port. Some ISPs register the MAC address of the network interface card in your computer when your account is first opened. They accept traffic only from the MAC address of that computer. This feature allows your modem router to use your computer's MAC address (also called cloning).	
Use Default Address	Use the default MAC address.
Use Computer MAC Address	The modem router captures and uses the MAC address of the computer that you are now using. You must use the one computer that is registered by the ISP.
Use This MAC Address	Enter the MAC address that you want to use. By default, the field displays the MAC address of the Internet port.

13. Click the **Apply** button.

Your settings are saved.

14. Click the **Test** button to test your Internet connection.

If the NETGEAR website does not display within one minute, see [Troubleshoot the Internet Connection](#) on page 265.

Specify a Cable or Fiber Connection With a Login and PPTP or L2TP Service

If you want to manually configure the cable or fiber connection settings, use the information that your ISP gave you to connect to your Internet service. If you cannot find this information, contact your ISP. Entering incorrect information might prevent the modem router from connecting to the Internet.

- ▶ **To view or specify the settings for a cable or fiber Internet connection that requires a login and uses a PPTP or L2TP service:**

1. Launch a web browser from a computer or WiFi device that is connected to the network.
2. Enter **http://www.routerlogin.net**.
A login window opens.
3. Enter the modem router user name and password.
The user name is **admin**. The default password is **password**. The user name and password are case-sensitive.
The BASIC Home page displays.
4. Select **ADVANCED > Setup > WAN Setup**.
The WAN Setup page displays.

Nighthawk X4S AC2600 WiFi VDSL/ADSL Modem Router Model D7800

- From the **WAN Preference** menu, select **Must use Ethernet WAN**.

By default, the menu selection is **Must use DSL WAN**.

- Click the **Apply** button.

Your settings are saved and the modem router restarts.

Note If you use a WiFi device to connect to the modem router, you might need to log in again.

- Select **BASIC > Internet**.

The Internet Setup page displays.

- From the **Select Country** menu, select the country in which you use the modem router.

The **Select Country** menu is not available in all countries and might be masked out.

- From the **Select Internet Service Provider** menu, select the Internet service provider (ISP) that you are using.

If your ISP is not in the menu, select **Other**.

- Make sure that the **Enable This Interface** check box is selected.

- Scroll down to the Does your Internet connection require a login? section and select the **Yes** radio button.

The following figure shows the settings that display when you configure a cable or fiber connection with a login and PPTP service.

The screenshot shows the 'Internet Setup' configuration page. At the top, there are three buttons: 'Test', 'Cancel', and 'Apply'. Below the buttons, the page is divided into several sections:

- Does your Internet connection require a login?**: Two radio buttons, 'Yes' (selected) and 'No'.
- Internet Service Provider**: A dropdown menu set to 'PPTP'.
- Login**: A text input field.
- Password**: A text input field.
- Connection Mode**: A dropdown menu set to 'Always On'.
- Idle Timeout(In Minutes)**: A text input field set to '5'.
- My IP Address**: Four text input fields for IP address components.
- IP Subnet Mask**: Four text input fields for subnet mask components.
- Server Address**: A text input field.
- Gateway IP Address**: Four text input fields for gateway IP address components.
- Connection ID/Name**: A text input field.
- Domain Name Server (DNS) Address**: Two radio buttons, 'Get Automatically from ISP' (selected) and 'Use These DNS Servers'. Below are two text input fields for 'Primary DNS' and 'Secondary DNS'.
- Router MAC Address**: Three radio buttons, 'Use Default Address' (selected), 'Use Computer MAC Address', and 'Use This MAC Address'. A text input field next to the third option contains the value 'a0:63:91:7a:14:99'.

Nighthawk X4S AC2600 WiFi VDSL/ADSL Modem Router Model D7800

12. Enter the cable or fiber settings as described in the following table.

Field	Description
Internet Service Provider	<p>Select the encapsulation, as indicated by your ISP:</p> <ul style="list-style-type: none"> • PPTP. Your Internet connection uses Point-to-Point Tunneling Protocol. • L2TP. Your Internet connection uses Layer Two Tunneling Protocol.
Login	<p>Enter the login name that you use to log in to your Internet service, as indicated by your ISP.</p> <p>This login name is often an email address.</p>
Password	<p>Enter the password that you use to log in to your Internet service, as indicated by your ISP.</p>
Connection Mode	<p>Select how the Internet connection functions:</p> <ul style="list-style-type: none"> • Always On. Once the Internet connection is established, it remains active. This is the default setting. • Dial on Demand. When someone attempts to connect to the Internet, the Internet connection is established. When the idle time-out period expires, the Internet connection is terminated. • Manually Connect. You must connect to the Internet manually (see View, Establish, or Terminate the PPTP or L2TP Internet Connection on page 217).
Idle Timeout (In Minutes)	<p>If you select Dial on Demand from the Connection Mode menu, enter the idle time-out period in minutes.</p> <p>The idle time-out specifies how long the modem router keeps the Internet connection active when no one on the network is using the Internet connection. The default is 5 minutes. To disable the idle time-out, enter 0. (When you disable the idle time-out, the connection is not terminated automatically.)</p>
My IP Address	<p>Enter the IP address that is assigned by your ISP to make the connection with the ISP server.</p>
IP Subnet Mask	<p>Enter the IP subnet mask that is assigned by your ISP to make the connection with the ISP server.</p>
Server Address	<p>Enter the IP address of the ISP server that your ISP gave you.</p>
Gateway IP Address	<p>Enter the IP address of the ISP gateway that your ISP gave you.</p> <p>If your ISP did not give you a gateway IP address, leave this field blank.</p>
Connection ID/Name	<p>Enter the IP connection ID or name that your ISP gave you.</p> <p>If your ISP did not give you a connection ID or name, leave this field blank. (It is not common that you must enter a connection ID or name.)</p> <hr/> <p>Note This field displays for PPTP service only.</p> <hr/>

Manage the Internet Settings Manually

(Continued)

Field	Description
Internet IP Address	
Get Dynamically from ISP	Your ISP uses DHCP to assign your IP address. Your ISP automatically assigns these addresses.
Use Static IP Address	Enter the IP address, IP subnet mask, and gateway IP address that your ISP assigned you for static IP address service. The gateway is the ISP router to which your modem router connects.
Domain Name Server (DNS) Address	
The DNS server is used to look up site addresses based on their domain names.	
Get Automatically from ISP	Your ISP uses DHCP to assign your DNS servers. Your ISP automatically assigns this address.
Use These DNS Servers	If you know that your ISP does not automatically transmit DNS addresses to the modem router during login, select this option and enter the IP address of your ISP primary DNS server. If a secondary DNS server address is available, enter it also.
Router MAC Address	
The Ethernet MAC address that the modem router uses on the Internet port. Some ISPs register the MAC address of the network interface card in your computer when your account is first opened. They accept traffic only from the MAC address of that computer. This feature allows your modem router to use your computer's MAC address (also called cloning).	
Use Default Address	Use the default MAC address.
Use Computer MAC Address	The modem router captures and uses the MAC address of the computer that you are now using. You must use the one computer that is registered by the ISP.
Use This MAC Address	Enter the MAC address that you want to use. By default, the field displays the MAC address of the Internet port.

13. Click the **Apply** button.
Your settings are saved.

14. Click the **Test** button to test your Internet connection.
If the NETGEAR website does not display within one minute, see [Troubleshoot the Internet Connection](#) on page 265.

Specify an IPv6 Internet Connection

If you want to use an IPv6 Internet connection, you must specify the settings manually. NETGEAR genie and the Setup Wizard do not detect an IPv6 Internet connection automatically.

IPv6 Internet Connections and IPv6 Addresses

The modem router can support an IPv6 Internet connection through the following connection types:

- **Auto Detect.** For more information, see *Set Up an IPv6 Connection Through Auto Detect* on page 78.
- **6to4 tunnel.** For more information, see *Set Up an IPv6 6to4 Tunnel Connection* on page 80.
- **Pass-through.** For more information, see *Set Up an IPv6 Pass-Through Connection* on page 82.
- **Fixed.** For more information, see *Set Up an IPv6 Fixed Connection* on page 82.
- **DHCP.** For more information, see *Set Up an IPv6 DHCP Connection* on page 84.
- **PPP over Ethernet.** For more information, see *Set Up an IPv6 PPPoE Connection* on page 86.
- **Auto Config.** For more information, see *Set Up an IPv6 Connection Through Auto Config* on page 88.

Which connection type you must use depends on your IPv6 ISP. Follow the directions that your IPv6 ISP gave you.

- If your ISP did not provide details, use the 6to4 tunnel connection type (see *Set Up an IPv6 6to4 Tunnel Connection* on page 80).
- If you are not sure what type of IPv6 connection the modem router uses, use the Auto Detect connection type, which lets the modem router detect the IPv6 type that is in use (see *Set Up an IPv6 Connection Through Auto Detect* on page 78).
- If your Internet connection does not use PPPoE, DHCP, a fixed IP address, or pass-through but is IPv6, use the Auto Config connection type, which lets the modem router autoconfigure its IPv6 connection (see *Set Up an IPv6 Connection Through Auto Config* on page 88).

When you enable IPv6 and select any connection type other than IPv6 pass-through, the modem router starts the stateful packet inspection (SPI) firewall function on the WAN interface. The modem router creates connection records and checks every inbound IPv6 packet. If the inbound packet is not destined to the modem router itself and the modem router does not expect to receive such a packet, or the packet is not in the connection record, the modem router blocks this packet. This function works in two modes: In secured mode, the modem router inspects both TCP and UDP packets. In open mode, the modem router inspects UDP packets only.

IPv6 addresses are denoted by eight groups of hexadecimal quartets that are separated by colons. You can reduce any four-digit group of zeros within an IPv6 address to a single zero or omit it. The following errors invalidate an IPv6 address:

- More than eight groups of hexadecimal quartets
- More than four hexadecimal characters in a quartet
- More than two colons in a row

Set Up an IPv6 Connection Through Auto Detect

If you are not sure what type of IPv6 connection the modem router uses, use the Auto Detect connection type, which lets the modem router detect the IPv6 type that is in use.

► To set up an IPv6 Internet connection through auto detection:

1. Launch a web browser from a computer or WiFi device that is connected to the network.
2. Enter **http://www.routerlogin.net**.
A login window opens.
3. Enter the modem router user name and password.
The user name is **admin**. The default password is **password**. The user name and password are case-sensitive.
The BASIC Home page displays.
4. Select **ADVANCED > Advanced Setup > IPv6**.
The IPv6 page displays.
5. From the **Internet Connection Type** menu, select **Auto Detect**.

The screenshot shows the IPv6 configuration page. At the top, there are three buttons: "Status Refresh", "Cancel", and "Apply". Below the title bar, there are several sections: "Internet Connection Type" with a dropdown menu set to "Auto Detect"; "Connection Type" with a dropdown menu set to "DHCP/Auto Config"; "Router's IPv6 Address On WAN" with the text "Not Available"; "LAN Setup" with "Router's IPv6 Address On LAN" set to "Not Available"; "IP Address Assignment" with radio buttons for "Use DHCP Server" and "Auto Config" (selected); "Use This Interface ID" with a checkbox and four input fields containing "0"; and "IPv6 Filtering" with radio buttons for "Secured" (selected) and "Open".

The modem router automatically detects the information in the following fields:

- **Connection Type.** This field indicates the connection type that is detected.
 - **Router's IPv6 Address On WAN.** This field shows the IPv6 address that is acquired for the modem router's WAN (or Internet) interface. The number after the slash (/) is the length of the prefix, which is also indicated by the underline () under the IPv6 address. If no address is acquired, the field displays Not Available.
 - **Router's IPv6 Address On LAN.** This field shows the IPv6 address that is acquired for the modem router's LAN interface. The number after the slash (/) is the length of the prefix, which is also indicated by the underline () under the IPv6 address. If no address is acquired, the field displays Not Available.
6. Select an IP Address Assignment radio button:

Nighthawk X4S AC2600 WiFi VDSL/ADSL Modem Router Model D7800

- **Use DHCP Server.** The modem router assigns IPv6 addresses to the devices on your home network (the LAN) through a DHCP server. This method passes more information to LAN devices, but some IPv6 systems might not support the DHCPv6 client function.
 - **Auto Config.** This is the default setting.
7. To specify the interface ID for the IPv6 address of the modem router's LAN interface, select the **Use This Interface ID** check box, and enter the interface ID.
If you do not specify an ID here, the modem router generates one automatically from its MAC address.
8. Select the IPv6 filtering mode:
- **Secured.** In secured mode, which is the default mode, the modem router inspects both TCP and UDP packets.
 - **Open.** In open mode, the modem router inspects UDP packets only.
9. Click the **Apply** button.
Your settings are saved.

Set Up an IPv6 6to4 Tunnel Connection

With an IPv6 connection, your modem router creates a 6to4 tunnel to a remote relay router. Make sure that the IPv4 Internet connection is working before you apply the 6to4 tunnel settings for the IPv6 connection.

Note Follow the directions that your IPv6 ISP gave you.

► To set up an IPv6 Internet connection by using a 6to4 tunnel:

1. Launch a web browser from a computer or WiFi device that is connected to the network.
2. Enter **http://www.routerlogin.net**.
A login window opens.
3. Enter the modem router user name and password.
The user name is **admin**. The default password is **password**. The user name and password are case-sensitive.
The BASIC Home page displays.
4. Select **ADVANCED > Advanced Setup > IPv6**.
The IPv6 page displays.

5. From the **Internet Connection Type** menu, select **6to4 Tunnel**.

The modem router automatically detects the information in the Router's IPv6 Address On LAN field. This field shows the IPv6 address that is acquired for the modem router's LAN interface. The number after the slash (/) is the length of the prefix, which is also indicated by the underline () under the IPv6 address.

6. Select a Remote 6to4 Relay Router radio button:
 - **Auto.** Your modem router uses any remote relay modem router that is available on the Internet. This is the default setting.
 - **Static IP Address.** Enter the static IPv4 (*not* IPv6) address of the remote relay modem router. Your IPv6 ISP usually provides this address.
7. Select an IP Address Assignment radio button:
 - **Use DHCP Server.** The modem router assigns IPv6 addresses to the devices on your home network (the LAN) through a DHCP server. This method passes more information to LAN devices, but some IPv6 systems might not support the DHCPv6 client function. This is the default setting.
 - **Auto Config.** The modem router automatically configures its IPv6 address based on the IPv6 protocol.
8. To specify the interface ID for the IPv6 address of the modem router's LAN interface, select the **Use This Interface ID** check box, and enter the interface ID.
If you do not specify an ID here, the modem router generates one automatically from its MAC address.
9. Select the IPv6 filtering mode:
 - **Secured.** In secured mode, which is the default mode, the modem router inspects both TCP and UDP packets.
 - **Open.** In open mode, the modem router inspects UDP packets only.
10. Click the **Apply** button.
Your settings are saved.

Set Up an IPv6 Pass-Through Connection

In IPv6 pass-through mode, the modem router works as a Layer 2 Ethernet switch with two ports (LAN and WAN Ethernet ports) for IPv6 packets. The modem router does not process any IPv6 header packets.

Note Follow the directions that your IPv6 ISP gave you.

► To set up an IPv6 pass-through Internet connection:

1. Launch a web browser from a computer or WiFi device that is connected to the network.
2. Enter **http://www.routerlogin.net**.
A login window opens.
3. Enter the modem router user name and password.
The user name is **admin**. The default password is **password**. The user name and password are case-sensitive.
The BASIC Home page displays.
4. Select **ADVANCED > Advanced Setup > IPv6**.
The IPv6 page displays.
5. From the **Internet Connection Type** menu, select **Pass Through**.
The page adjusts, but no additional fields display.
6. Click the **Apply** button.
Your settings are saved.

Set Up an IPv6 Fixed Connection

A fixed IPv6 connection is based on a static or fixed IPv6 address that your IPv6 ISP gave you.

Note Follow the directions that your IPv6 ISP gave you.

► To set up a fixed IPv6 Internet connection:

1. Launch a web browser from a computer or WiFi device that is connected to the network.
2. Enter **http://www.routerlogin.net**.
A login window opens.
3. Enter the modem router user name and password.
The user name is **admin**. The default password is **password**. The user name and password are case-sensitive.
The BASIC Home page displays.
4. Select **ADVANCED > Advanced Setup > IPv6**.
The IPv6 page displays.

- From the **Internet Connection Type** menu, select **Fixed**.

- Configure the fixed IPv6 addresses for the WAN connection:

- **IPv6 Address/Prefix Length.** The IPv6 address and prefix length of the modem router WAN interface that your ISP provided to you.
- **Default IPv6 Gateway.** The IPv6 address of the default IPv6 gateway for the modem router's WAN interface that your ISP provided to you.
- **Primary DNS Server.** The primary DNS server that resolves IPv6 domain name records for the modem router that your ISP provided to you.
- **Secondary DNS Server.** The secondary DNS server that resolves IPv6 domain name records for the modem router that your ISP provided to you.

Note If you do not specify the DNS servers, the modem router uses the DNS servers that are configured for the IPv4 Internet connection on the Internet Setup page (see [Manually Set Up an ADSL Internet Connection](#) on page 49, [Manually Set Up a VDSL Internet Connection](#) on page 58, or [Manually Set Up a Cable or Fiber Internet Connection](#) on page 66).

- Select an IP Address Assignment radio button:

- **Use DHCP Server.** The modem router assigns IPv6 addresses to the devices on your home network (the LAN) through a DHCP server. This method passes more information to LAN devices, but some IPv6 systems might not support the DHCPv6 client function. This is the default setting.
- **Auto Config.** The modem router automatically configures its IPv6 address based on the IPv6 protocol.

- In the **IPv6 Address/Prefix Length** fields, specify the static IPv6 address and prefix length of the modem router's LAN interface.

If you do not specify an address here, the modem router generates one automatically from its MAC address.

9. Select the IPv6 filtering mode:
 - **Secured.** In secured mode, which is the default mode, the modem router inspects both TCP and UDP packets.
 - **Open.** In open mode, the modem router inspects UDP packets only.
10. Click the **Apply** button.
Your settings are saved.

Set Up an IPv6 DHCP Connection

An IPv6 DHCP connection is based on a dynamic IPv6 address that a DHCPv6 server assigns to the modem router.

Note Follow the directions that your IPv6 ISP gave you.

► To set up an IPv6 Internet connection with a DHCP server:

1. Launch a web browser from a computer or WiFi device that is connected to the network.
2. Enter **http://www.routerlogin.net**.
A login window opens.
3. Enter the modem router user name and password.
The user name is **admin**. The default password is **password**. The user name and password are case-sensitive.
The BASIC Home page displays.
4. Select **ADVANCED > Advanced Setup > IPv6**.
The IPv6 page displays.

- From the **Internet Connection Type** menu, select **DHCP**.

The modem router automatically detects the information in the following fields:

- Router's IPv6 Address On WAN.** This field shows the IPv6 address that is acquired for the modem router's WAN (or Internet) interface. The number after the slash (/) is the length of the prefix, which is also indicated by the underline (_) under the IPv6 address. If no address is acquired, the field displays Not Available.
 - Router's IPv6 Address On LAN.** This field shows the IPv6 address that is acquired for the modem router's LAN interface. The number after the slash (/) is the length of the prefix, which is also indicated by the underline (_) under the IPv6 address. If no address is acquired, the field displays Not Available.
- If your IPv6 ISP gave you a specific host name, in the **User Class (If Required)** field, enter the host name.
 If your IPv6 ISP did not give you a specific host name, you can leave this field blank.
 - To specify a domain name, in the **Domain Name (If Required)** field, enter a domain name.
 If your ISP gave you a specific domain name, enter it in this field. (For example, Earthlink Cable might require a host name of *home*, and Comcast sometimes supplies a domain name.)
 If your ISP did not give you a specific domain name, you can either leave this field blank or enter the domain name of your IPv6 ISP. (Do not enter the domain name for the IPv4 ISP here.) For example, if your ISP's mail server is mail.xxx.yyy.zzz, enter xxx.yyy.zzz as the domain name.
 - Select an IP Address Assignment radio button:
 - Use DHCP Server.** The modem router assigns IPv6 addresses to the devices on your home network (the LAN) through a DHCP server. This method passes more information to LAN devices, but some IPv6 systems might not support the DHCPv6 client function. This is the default setting.
 - Auto Config.** The modem router automatically configures its IPv6 address based on the IPv6 protocol.
 - To specify the interface ID for the IPv6 address of the modem router's LAN interface, select the **Use This Interface ID** check box, and enter the interface ID.
 If you do not specify an ID here, the modem router generates one automatically from its MAC address.

10. Select the IPv6 filtering mode:
 - **Secured.** In secured mode, which is the default mode, the modem router inspects both TCP and UDP packets.
 - **Open.** In open mode, the modem router inspects UDP packets only.
11. Click the **Apply** button.
Your settings are saved.

Set Up an IPv6 PPPoE Connection

An IPv6 PPPoE connection is based on a dynamic IPv6 address that a PPPoE service assigns to the modem router.

Note Follow the directions that your IPv6 ISP gave you.

► To set up an IPv6 PPPoE Internet connection:

1. Launch a web browser from a computer or WiFi device that is connected to the network.
2. Enter **http://www.routerlogin.net**.
A login window opens.
3. Enter the modem router user name and password.
The user name is **admin**. The default password is **password**. The user name and password are case-sensitive.
The BASIC Home page displays.
4. Select **ADVANCED > Advanced Setup > IPv6**.
The IPv6 page displays.

- From the **Internet Connection Type** menu, select **PPPoE**.

The modem router automatically detects the information in the following fields:

- **Router's IPv6 Address On WAN.** This field shows the IPv6 address that is acquired for the modem router's WAN (or Internet) interface. The number after the slash (/) is the length of the prefix, which is also indicated by the underline () under the IPv6 address. If no address is acquired, the field displays Not Available.
- **Router's IPv6 Address On LAN.** This field shows the IPv6 address that is acquired for the modem router's LAN interface. The number after the slash (/) is the length of the prefix, which is also indicated by the underline () under the IPv6 address. If no address is acquired, the field displays Not Available.

- In the **Login** field, enter the login information for the ISP connection.

This is usually the name that you use in your email address. For example, if your main mail account is JerAB@ISP.com, you would enter JerAB in this field. Some ISPs (such as Earthlink) require that you use your full email address when you log in. If your ISP requires your full email address, enter it in this field.

- In the **Password** field, enter the password for the ISP connection.

- In the **Service Name (If Required)** field, enter a service name.

If your ISP did not provide a service name, leave this field blank.

Note The default setting of the **Connection Mode** menu is **Always On** to provide a steady IPv6 connection. The modem router never terminates the connection. If the connection is terminated, for example, when the modem is turned off, the modem router attempts to reestablish the connection immediately after the PPPoE connection becomes available again.

9. Select an IP Address Assignment radio button:
 - **Use DHCP Server.** The modem router assigns IPv6 addresses to the devices on your home network (the LAN) through a DHCP server. This method passes more information to LAN devices, but some IPv6 systems might not support the DHCPv6 client function. This is the default setting.
 - **Auto Config.** The modem router automatically configures its IPv6 address based on the IPv6 protocol.
10. To specify the interface ID for the IPv6 address of the modem router's LAN interface, select the **Use This Interface ID** check box, and enter the interface ID.

If you do not specify an ID here, the modem router generates one automatically from its MAC address.
11. Select the IPv6 filtering mode:
 - **Secured.** In secured mode, which is the default mode, the modem router inspects both TCP and UDP packets
 - **Open.** In open mode, the modem router inspects UDP packets only.
12. Click the **Apply** button.

Your settings are saved.

Set Up an IPv6 Connection Through Auto Config

If your Internet connection does not use PPPoE, DHCP, a fixed IP address, or pass-through but is IPv6, use the Auto Config connection type, which lets the modem router autoconfigure its IPv6 connection.

► To set up an IPv6 Internet connection through autoconfiguration:

1. Launch a web browser from a computer or WiFi device that is connected to the network.
2. Enter **http://www.routerlogin.net**.

A login window opens.
3. Enter the modem router user name and password.

The user name is **admin**. The default password is **password**. The user name and password are case-sensitive.

The BASIC Home page displays.
4. Select **ADVANCED > Advanced Setup > IPv6**.

The IPv6 page displays.

- From the **Internet Connection Type** menu, select **Auto Config**.

The modem router automatically detects the information in the following fields:

- **Router's IPv6 Address On WAN.** This field shows the IPv6 address that is acquired for the modem router's WAN (or Internet) interface. The number after the slash (/) is the length of the prefix, which is also indicated by the underline () under the IPv6 address. If no address is acquired, the field displays Not Available.
 - **Router's IPv6 Address On LAN.** This field shows the IPv6 address that is acquired for the modem router's LAN interface. The number after the slash (/) is the length of the prefix, which is also indicated by the underline () under the IPv6 address. If no address is acquired, the field displays Not Available.
- If your ISP gave you a specific user class, in the **DHCP User Class (If Required)** field, enter the user class.
If your ISP did not give you a specific user class, leave this field blank.
 - To specify a domain name, in the **DHCP Domain Name (If Required)** field, enter a domain name.
If your ISP gave you a specific domain name, enter it in this field. (For example, Earthlink Cable might require a host name of *home*, and Comcast sometimes supplies a domain name.)
If your ISP did not give you a specific domain name, you can either leave this field blank or enter the domain name of your IPv6 ISP. (Do not enter the domain name for the IPv4 ISP here.) For example, if your ISP's mail server is mail.xxx.yyy.zzz, enter xxx.yyy.zzz as the domain name.
 - Select an IP Address Assignment radio button:
 - **Use DHCP Server.** The modem router assigns IPv6 addresses to the devices on your home network (the LAN) through a DHCP server. This method passes more information to LAN devices, but some IPv6 systems might not support the DHCPv6 client function.
 - **Auto Config.** This is the default setting.
 - To specify the interface ID for the IPv6 address of the modem router's LAN interface, select the **Use This Interface ID** check box, and enter the interface ID.
If you do not specify an ID here, the modem router generates one automatically from its MAC address.

10. Select the IPv6 filtering mode:

- **Secured.** In secured mode, which is the default mode, the modem router inspects both TCP and UDP packets.
- **Open.** In open mode, the modem router inspects UDP packets only.

11. Click the **Apply** button.

Your settings are saved.

Manage the MTU Size

The maximum transmission unit (MTU) is the largest data packet a network device transmits.

MTU Concepts

When one network device communicates across the Internet with another, the data packets travel through many devices along the way. If a device in the data path uses a lower maximum transmission unit (MTU) setting than the other devices, the data packets must be split or “fragmented” to accommodate the device with the smallest MTU.

The best MTU setting for NETGEAR equipment is often the default value. In some situations, changing the value fixes one problem but causes another.

Leave the MTU unchanged unless one of these situations occurs:

- You experience problems connecting to your ISP or other Internet service, and the technical support of either the ISP or NETGEAR recommends changing the MTU setting. These web-based applications might require an MTU change:
 - A secure website that does not open or displays only part of a web page
 - Yahoo email
- You use VPN and experience severe performance problems.
- You used a program to optimize MTU for performance reasons and now you are experiencing connectivity or performance problems.

If you suspect an MTU problem, a common solution is to change the MTU to 1400. If you are willing to experiment, you can gradually reduce the MTU from the maximum value of 1500 until the problem goes away. The following table describes common MTU sizes and applications.

Table 3. Common MTU sizes

MTU	Application
1500	The largest Ethernet packet size. This setting is typical for connections that do not use PPPoE or VPN and is the default value for NETGEAR modem routers, adapters, and switches.
1492	Used in PPPoE environments.

Table 3. Common MTU sizes (Continued)

MTU	Application
1472	Maximum size to use for pinging. (Larger packets are fragmented.)
1468	Used in some DHCP environments.
1458	Used in PPPoA environments.
1436	Used in PPTP environments or with VPN.

Change the MTU Size



WARNING:

An incorrect MTU setting can cause Internet communication problems. For example, you might not be able to access certain websites, frames within websites, secure login pages, or FTP or POP servers. Change the MTU only if you are sure that it is necessary for your ISP connection.

► To change the MTU size:

1. Launch a web browser from a computer or mobile device that is connected to the network.
2. Enter **http://www.routerlogin.net**.
A login window opens.
3. Enter the modem router user name and password.
The user name is **admin**. The default password is **password**. The user name and password are case-sensitive.
The BASIC Home page displays.
4. Select **ADVANCED > Setup > WAN Setup**.
The WAN Setup page displays.
5. In the **MTU Size** field, enter a value from 616 to 1500.
The normal MTU (maximum transmit unit) value for most Ethernet networks is 1500 bytes, 1492 bytes for PPPoE connections, or 1436 for PPTP connections.
6. Click the **Apply** button.
Your settings are saved.

Manage the Basic WiFi Network Settings 4

This chapter describes how you can manage the basic WiFi network settings of the modem router. For information about the advanced WiFi settings, see *Manage the Advanced WiFi Features* on page 228.

The chapter includes the following sections:

- *Manage the Basic WiFi Settings and WiFi Security of the Main Network* on page 93
- *Use WPS to Add a Device to the WiFi Network* on page 102
- *Manage the Basic WiFi Settings and WiFi Security of the Guest Network* on page 105
- *Control the WiFi Radios* on page 108

For information about setting up an access control list (ACL) and managing WiFi access for enhanced security, see *Manage Network Access Control Lists* on page 115.

Manage the Basic WiFi Settings and WiFi Security of the Main Network

The modem router comes with preset security. This means that the WiFi network name (SSID), network key (password), and security option (encryption protocol) are preset in the factory. The preset SSID and password are uniquely generated for every device to protect and maximize your WiFi security. You can find the preset SSID and password on the product label (see *Bottom Panel Product Label* on page 17).

IMPORTANT:

We recommend that you do *not* change your preset security settings. If you do decide to change your preset security settings, make a note of the new settings and store the note in a safe place where you can easily find it.

View or Change the Basic WiFi Settings

You can view or change the basic WiFi settings and WiFi security. The modem router simultaneously supports the 2.4 GHz band for 802.11b/g/n devices and the 5 GHz band for 802.11a/n/ac devices.

Tip If you do decide to change the WiFi settings of the modem router's main network, use a wired connection to avoid being disconnected when the new WiFi settings take effect.

► **To view or change the basic WiFi settings:**

1. Launch a web browser from a computer or WiFi device that is connected to the network.
2. Enter **http://www.routerlogin.net**.
A login window opens.
3. Enter the modem router user name and password.
The user name is **admin**. The default password is **password**. The user name and password are case-sensitive.
The BASIC Home page displays.

4. Select **Wireless**.

Wireless Settings

Region Selection
 Region:

Wireless Network(2.4GHz b/g/n)
 Enable SSID Broadcast
 Name (SSID):
 Channel:
 Mode:

Security Options
 None
 WPA2-PSK [AES]
 WPA-PSK [TKIP] + WPA2-PSK [AES]
 WPAWPA2 Enterprise

Security Options (WPA2-PSK)
 Password (Network Key) : (8-63 characters or 64 hex digits)

Wireless Network (5GHz 802.11a/n/ac)
 Enable SSID Broadcast
 Enable Video Network
 Name (SSID):
 Channel:
 Mode:

Security Options
 None
 WPA2-PSK [AES]
 WPA-PSK [TKIP] + WPA2-PSK [AES]
 WPAWPA2 Enterprise

Security Options (WPA2-PSK)
 Password (Network Key) : (8-63 characters or 64 hex digits)

5. View or change the basic WiFi settings and security settings.
 The following table describes the fields on the Wireless Settings page.

Field	Description
Region Selection	
Region	From the menu, select the region in which the modem router operates. Note It might not be legal to operate the modem router in a region other than the regions listed in the menu. If your country or region is not listed, check with your local government agency.
Wireless Network (2.4GHz b/g/n)	

Nighthawk X4S AC2600 WiFi VDSL/ADSL Modem Router Model D7800

(Continued)

Field	Description
Enable SSID Broadcast	By default, the modem router broadcasts its SSID so that WiFi stations can detect the WiFi name (SSID) in their scanned network lists. To turn off the SSID broadcast, clear the Enable SSID Broadcast check box. Turning off the SSID broadcast provides additional WiFi security, but users must know the SSID to be able to join the WiFi network of the modem router.
Name (SSID)	<p>The SSID is the WiFi network name. If you did not change the SSID, the default SSID displays. The default SSID is also printed on the product label (see <i>Bottom Panel Product Label</i> on page 17).</p> <hr/> <p>Note We recommend that you do not change the default SSID. If you must change the SSID, enter a 32-character (maximum), case-sensitive name in this field.</p> <hr/>
Channel	<p>From the Channel menu, select Auto for automatic channel selection or select an individual channel. The default selection is Auto.</p> <hr/> <p>Note In some regions, not all channels are available. Do not change the channel unless you experience interference (shown by lost connections or slow data transfers). If this situation occurs, experiment with different channels to see which is the best.</p> <hr/> <p>Note If you use multiple WiFi access points (APs), reduce interference by selecting different channels for adjacent APs. We recommend a channel spacing of four channels between adjacent APs (for example, use Channels 1 and 5, or 6 and 10).</p> <hr/>
Mode	<p>From the Mode menu, select one of the following modes:</p> <ul style="list-style-type: none"> • Up to 54 Mbps. Legacy mode. This mode allows 802.11n, 802.11g, and 802.11b devices to join the network but limits 802.11n devices to functioning at up to 54 Mbps. • Up to 289 Mbps. Neighbor-friendly mode for reduced interference with neighboring WiFi networks. This mode allows 802.11n, 802.11g, and 802.11b devices to join the network but limits 802.11n devices to functioning at up to 289 Mbps. • Up to 800 Mbps. Performance mode. This mode allows 802.11n, 802.11g, and 802.11b devices to join the network and allows 802.11n devices to function at up to 600 Mbps. This mode is the default mode. <hr/> <p>Note The 800 Mbps performance mode requires 256 QAM support on the WiFi client.</p> <hr/> <p>Note WPA-PSK security supports speeds of up to 54 Mbps. Even if your devices are capable of a higher speed, WPA-PSK security limits their speed to 54 Mbps.</p> <hr/>

Manage the Basic WiFi Network Settings

(Continued)

Field	Description
<p>Security Options</p> <p>This information applies to the 2.4 GHz WiFi network.</p>	
<p>Note We recommend that you do <i>not</i> change your preset security settings (WPA2-PSK [AES]).</p>	
<p>If you must change the WiFi security, select one of the following WiFi security options for the modem router's WiFi network:</p> <ul style="list-style-type: none"> • None. An open WiFi network that does not provide any security. Any WiFi device can join the network. We recommend that you do <i>not</i> use an open WiFi network. • WEP. Wired Equivalent Privacy (WEP) security is a legacy authentication and data encryption mode that is superseded by WPA-PSK and WPA2-PSK. The WEP option displays only if you select Up to 54 Mbps from the Mode menu. For information about configuring WEP, see <i>Configure WEP Legacy WiFi Security</i> on page 100. • WPA2-PSK [AES]. This option is the default setting. This type of security enables WiFi devices that support WPA2 to join the modem router's 2.4 GHz WiFi network. If you did not change the passphrase, the default passphrase displays. The default passphrase is printed on the product label (see <i>Bottom Panel Product Label</i> on page 17). WPA2 provides a secure connection but some older WiFi devices do not detect WPA2 and support only WPA. If your network includes such older devices, select WPA-PSK [TKIP] + WPA2-PSK [AES] security. We recommend that you do not change the default passphrase. If you must change the passphrase, in the Passphrase field, enter a phrase of 8 to 63 characters. To join the modem router's WiFi network, a user must enter this passphrase. • WPA-PSK [TKIP] + WPA2-PSK [AES]. This type of security enables WiFi devices that support either WPA or WPA2 to join the modem router's 2.4 GHz WiFi network. However, WPA-PSK [TKIP] is less secure than WPA2-PSK [AES] and limits the speed of WiFi devices to 54 Mbps. To use this type of security, in the Passphrase field, enter a phrase of 8 to 63 characters. To join the modem router's WiFi network, a user must enter this passphrase. • WPA/WPA2 Enterprise. This type of security requires that your WiFi network can access a RADIUS server. For information about configuring WPA/WPA2 Enterprise, see <i>Configure WPA/WPA2 Enterprise WiFi Security</i> on page 99. 	
<p>Wireless Network (5GHz 802.11a/n/ac)</p>	
<p>Enable SSID Broadcast</p>	<p>By default, the modem router broadcasts its SSID so that WiFi stations can detect the WiFi name (SSID) in their scanned network lists. To turn off the SSID broadcast, clear the Enable SSID Broadcast check box. Turning off the SSID broadcast provides additional WiFi security, but users must know the SSID to be able to join the WiFi network of the modem router.</p>
<p>Enable Video Network</p>	<p>If you want to stream high-definition video, select this check box. When this option is selected, the modem router uses video reliability algorithms to reduce jitter and packet loss during video presentations. If you do not stream videos, leave this check box cleared.</p>

(Continued)

Field	Description
Name (SSID)	<p>The SSID is the WiFi network name. If you did not change the SSID, the default SSID displays. The default SSID is also printed on the product label (see <i>Bottom Panel Product Label</i> on page 17).</p> <hr/> <p>Note We recommend that you do not change the default SSID. If you must change the SSID, enter a 32-character (maximum), case-sensitive name in this field.</p> <hr/>
Channel	<p>From the Channel menu, select an individual channel. The default channel depends on your selection from the Region menu.</p> <hr/> <p>Note In some regions, not all channels are available. Do not change the channel unless you experience interference (shown by lost connections or slow data transfers). If this situation occurs, experiment with different channels to see which is the best.</p> <hr/> <p>Note If you use multiple WiFi access points (APs), reduce interference by selecting different channels for adjacent APs. We recommend a channel spacing of four channels between adjacent APs.</p> <hr/>
Mode	<p>From the Mode menu, select one of the following modes:</p> <ul style="list-style-type: none"> • Up to 347 Mbps. Legacy mode. This mode allows 802.11ac, 802.11n, and 802.11a devices to join the network but limits 802.11ac and 802.11n devices to functioning at up to 347 Mbps. • Up to 800 Mbps. Neighbor-friendly mode for reduced interference with neighboring WiFi networks. This mode allows 802.11ac, 802.11n, and 802.11a devices to join the network but limits 802.11ac devices to functioning at up to 800 Mbps. • Up to 1733 Mbps. Performance mode. This mode allows 802.11ac, 802.11n, and 802.11a devices to join the network and allows 802.11ac devices to function at up to 1733 Mbps. This mode is the default mode.

(Continued)

Field	Description
Security Options	
This information applies to the 5 GHz WiFi network.	
<hr/> <p>Note We recommend that you do <i>not</i> change your preset security settings (WPA2-PSK [AES]).</p> <hr/>	
<p>If you must change the WiFi security, select one of the following WiFi security options for the modem router's WiFi network:</p> <ul style="list-style-type: none"> • None. An open WiFi network that does not provide any security. Any WiFi device can join the network. We recommend that you do <i>not</i> use an open WiFi network. • WPA2-PSK [AES]. This option is the default setting. This type of security enables WiFi devices that support WPA2 to join the modem router's 5 GHz WiFi network. If you did not change the passphrase, the default passphrase displays. The default passphrase is printed on the product label (see Bottom Panel Product Label on page 17). WPA2 provides a secure connection but some older WiFi devices do not detect WPA2 and support only WPA. If your network includes such older devices, select WPA-PSK [TKIP] + WPA2-PSK [AES] security. We recommend that you do not change the default passphrase. If you must change the passphrase, in the Passphrase field, enter a phrase of 8 to 63 characters. To join the modem router's WiFi network, a user must enter this passphrase. • WPA-PSK [TKIP] + WPA2-PSK [AES]. This type of security enables WiFi devices that support either WPA or WPA2 to join the modem router's 5 GHz WiFi network. However, WPA-PSK [TKIP] is less secure than WPA2-PSK [AES] and limits the speed of WiFi devices to 54 Mbps. To use this type of security, in the Passphrase field, enter a phrase of 8 to 63 characters. To join the modem router's WiFi network, a user must enter this passphrase. • WPA/WPA2 Enterprise. This type of security requires that your WiFi network can access a RADIUS server. For information about configuring WPA/WPA2 Enterprise, see Configure WPA/WPA2 Enterprise WiFi Security on page 99. 	

6. Click the **Apply button.**

Your settings are saved.

If you connected over WiFi to the network and you changed the SSID, you are disconnected from the network.

7. Make sure that you can reconnect over WiFi to the network with its new settings.

If you cannot connect over WiFi, check the following:

- If your computer or WiFi device is already connected to another WiFi network in your area, disconnect it from that WiFi network and connect it to the WiFi network that the modem router provides. Some WiFi devices automatically connect to the first open network without WiFi security that they discover.
- If your computer or WiFi device is trying to connect to your network with its old settings (before you changed the settings), update the WiFi network selection in your computer or WiFi device to match the current settings for your network.
- Does your WiFi device display as an attached device? (See [View Devices Currently on the Network](#) on page 218.) If it does, it is connected to the network.

- Are you using the correct network name (SSID) and password?

Configure WPA/WPA2 Enterprise WiFi Security

Remote Authentication Dial In User Service (RADIUS) is an enterprise-level method for centralized Authentication, Authorization, and Accounting (AAA) management. To provide WPA/WPA2 enterprise WiFi security, the WiFi network that the modem router provides must be able to access a RADIUS server.

Tip If you want to change the WiFi settings of the modem router's main network, use a wired connection to avoid being disconnected when the new WiFi settings take effect.

► To configure WPA/WPA2 enterprise security:

1. Launch a web browser from a computer or WiFi device that is connected to the network.
2. Enter **http://www.routerlogin.net**.
A login window opens.
3. Enter the modem router user name and password.
The user name is **admin**. The default password is **password**. The user name and password are case-sensitive.
The BASIC Home page displays.
4. Select **Wireless**.
The Wireless Settings page displays.

Note If you are configuring a guest network, select **Guest Network** instead. The Guest Network Settings page displays.

5. In the Security Options section below either the Wireless Network (2.4GHz b/g/n) section or the Wireless Network (5GHz 802.11a/n/ac) section, select the **WPA/WPA2 Enterprise** radio button.

Security Options

None
 WEP
 WPA2-PSK [AES]
 WPA-PSK [TKIP] + WPA2-PSK [AES]
 WPA/WPA2 Enterprise

Security Options (WPA/WPA2 Enterprise)

WPA Mode:

RADIUS server IP Address:

RADIUS server Port:

RADIUS server Shared Secret:

6. In the Security Options (WPA/WPA2 Enterprise) section, enter the settings as described in the following table.

Manage the Basic WiFi Network Settings

Nighthawk X4S AC2600 WiFi VDSL/ADSL Modem Router Model D7800

Field	Description
WPA Mode	From the WPA Mode menu, select the enterprise mode: <ul style="list-style-type: none">• WPA [TKIP] +WPA2 [AES]. This type of security enables WiFi devices that support either WPA or WPA2 to join the modem router's WiFi network.• WPA2 [AES]. WPA2 provides a secure connection but some older WiFi devices do not detect WPA2 and support only WPA. If your network includes such older devices, select WPA [TKIP] + WPA2 [AES] security. If your network includes older devices only, select WPA [TKIP] security.• WPA [TKIP]. WPA provides a secure connection. If your network includes older devices only, select this type of security.
Group Key Update Interval	Enter the interval in seconds after which the RADIUS group key is updated. The default interval is 3600 seconds.
RADIUS server IP Address	Enter the IPv4 address of the RADIUS server to which the WiFi network can connect.
RADIUS server Port	Enter the number of the port on the modem router that is used to access the RADIUS server for authentication. The default port number is 1812.
RADIUS server Shared Secret	Enter the shared secret (RADIUS password) that is used between the modem router and the RADIUS server during authentication of a WiFi user.

7. Click the **Apply** button.

Your settings are saved.

8. Make sure that you can reconnect over WiFi to the network with its new security settings.

If you cannot connect over WiFi, check the following:

- If your computer or WiFi device is already connected to another WiFi network in your area, disconnect it from that WiFi network and connect it to the WiFi network that the modem router provides. Some WiFi devices automatically connect to the first open network without WiFi security that they discover.
- If your computer or WiFi device is trying to connect to your network with its old settings (before you changed the settings), update the WiFi network selection in your computer or WiFi device to match the current settings for your network.
- Does your WiFi device display as an attached device? (See [View Devices Currently on the Network](#) on page 218.) If it does, it is connected to the network.
- Are you using the correct network name (SSID) and password?

Configure WEP Legacy WiFi Security

Wired Equivalent Privacy (WEP) security is a legacy authentication and data encryption mode that is superseded by WPA-PSK and WPA2-PSK. WEP limits the WiFi transmission speed to 54 Mbps (the modem router is capable of speeds of up 800 Mbps).

Tip If you want to change the WiFi settings of the modem router's main network, use a wired connection to avoid being disconnected when the new WiFi settings take effect.

► To configure WEP security:

1. Launch a web browser from a computer or WiFi device that is connected to the network.
2. Enter **http://www.routerlogin.net**.
A login window opens.
3. Enter the modem router user name and password.
The user name is **admin**. The default password is **password**. The user name and password are case-sensitive.
The BASIC Home page displays.
4. Select **Wireless**.
The Wireless Settings page displays.
5. From the **Mode** menu, select **Up to 54 Mbps**.
The page adjusts to display the **WEP** radio button.
6. In the Security Options section, select the **WEP** radio button.

The screenshot shows the 'Security Options' section of the router's web interface. It features a list of radio buttons for selecting a security protocol: 'None', 'WEP' (which is selected), 'WPA2-PSK [AES]', 'WPA-PSK [TKIP] + WPA2-PSK [AES]', and 'WPAWPA2 Enterprise'. Below this is the 'Security Encryption (WEP)' section, which includes two dropdown menus: 'Authentication Type' set to 'Automatic' and 'Encryption Strength' set to '64-bit'. At the bottom is the 'Security Encryption (WEP) Key' section, which contains four radio buttons labeled 'Key 1', 'Key 2', 'Key 3', and 'Key 4', each followed by an empty text input field. 'Key 1' is selected.

7. From the **Authentication Type** menu, select one of the following types:
 - **Automatic**. Clients can use either Open System or Shared Key authentication.
 - **Shared Key**. Clients can use only Shared Key authentication.
8. From the **Encryption Strength** menu, select the encryption key size:
 - **64-bit**. Standard WEP encryption, using 40/64-bit encryption.
 - **128-bit**. Standard WEP encryption, using 104/128-bit encryption. This selection provides higher encryption security.
9. Specify the active key by selecting the **Key 1**, **Key 2**, **Key 3**, or **Key 4** radio button.
Only one key can be the active key. To join the modem router's WiFi network, a user must enter the key value for the key that you specified as the active key.

10. Enter a value for the key:

- For 64-bit WEP, enter 10 hexadecimal digits (any combination of 0–9, A–F). The key values are not case-sensitive.
- For 128-bit WEP, enter 26 hexadecimal digits (any combination of 0–9, A–F). The key values are not case-sensitive.

To join the modem router's WiFi network, a user must enter the key value for the key that you specified as the active key.

11. Click the **Apply** button.

Your settings are saved.

12. Make sure that you can reconnect over WiFi to the network with its new security settings.

If you cannot connect over WiFi, check the following:

- If your computer or WiFi device is already connected to another WiFi network in your area, disconnect it from that WiFi network and connect it to the WiFi network that the modem router provides. Some WiFi devices automatically connect to the first open network without WiFi security that they discover.
- If your computer or WiFi device is trying to connect to your network with its old settings (before you changed the settings), update the WiFi network selection in your computer or WiFi device to match the current settings for your network.
- Does your WiFi device display as an attached device? (See [View Devices Currently on the Network](#) on page 218.) If it does, it is connected to the network.
- Are you using the correct WiFi network name (SSID) and password?

Use WPS to Add a Device to the WiFi Network

WPS (Wi-Fi Protected Setup) lets you connect a WiFi-enabled computer or mobile device to the modem router's network without entering the WiFi network passphrase or key. Instead, you use a **WPS** button or enter a PIN to connect.

If you use the push button method, the computer or device that you are trying to connect must provide either a physical button or a software button. If you use the PIN method, you must know the PIN of the computer or device that you are trying to connect.

WPS supports WPA and WPA2 WiFi security. If your modem router network is open (no WiFi security is set, which is not the default setting for the modem router), connecting with WPS automatically sets WPA + WPA2 WiFi security on the modem router network and generates a random passphrase. You can view this passphrase (see [View or Change the Basic WiFi Settings](#) on page 93).

Use WPS With the Push Button Method

For you to use the push button method to connect a WiFi device to the modem router's WiFi network, the WiFi device that you are trying to connect must provide either a physical button or a software button. You can use the physical button and software button to let a WiFi device join only the main WiFi network, not the guest WiFi network.

► **To let a WiFi device join the modem router's main WiFi network using WPS with the push button method:**

1. Launch a web browser from a computer or mobile device that is connected to the network.
2. Enter **http://www.routerlogin.net**.
A login window opens.
3. Enter the modem router user name and password.
The user name is **admin**. The default password is **password**. The user name and password are case-sensitive.
The BASIC Home page displays.
4. Select **ADVANCED > WPS Wizard**.
The page displays a description of the WPS method.
5. Click the **Next** button.

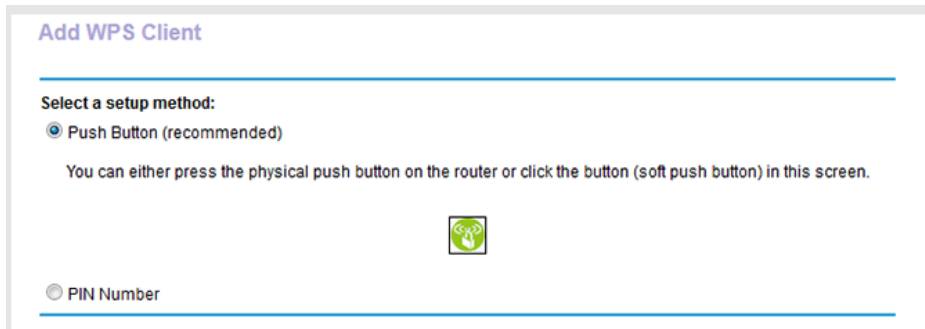

By default, the **Push Button (recommended)** radio button is selected.

6. Either click the  button onscreen or press the **WPS** button on the right side panel of the modem router. For two minutes, the modem router attempts to find the WiFi device (that is, the client) that you want to join the modem router's main WiFi network.
During this time, the WiFi LED on the top panel of the modem router blinks white.
7. Within two minutes, go to the WiFi device and press its **WPS** button to join the modem router's main WiFi network without entering a password.
After the modem router establishes a WPS connection, the WiFi LED lights solid white and the Add WPS Client page displays a confirmation message.
8. To verify that the WiFi device is connected to the modem router's main WiFi network, select **BASIC > Attached Devices**.
The WiFi device displays onscreen.

Use WPS With the PIN Method

To use the PIN method to connect a WiFi device to the modem router's WiFi network, you must know the PIN of the WiFi device that you are trying to connect.

► To let a WiFi device join the modem router's WiFi network using WPS with the PIN method:

1. Launch a web browser from a computer or mobile device that is connected to the network.
2. Enter **http://www.routerlogin.net**.
A login window opens.
3. Enter the modem router user name and password.
The user name is **admin**. The default password is **password**. The user name and password are case-sensitive.
The BASIC Home page displays.
4. Select **ADVANCED > WPS Wizard**.
The page displays a description of the WPS method.
5. Click the **Next** button.
The Add WPS Client page adjusts.
The **Push Button (recommended)** radio button is selected by default.
6. Select the **PIN Number** radio button.

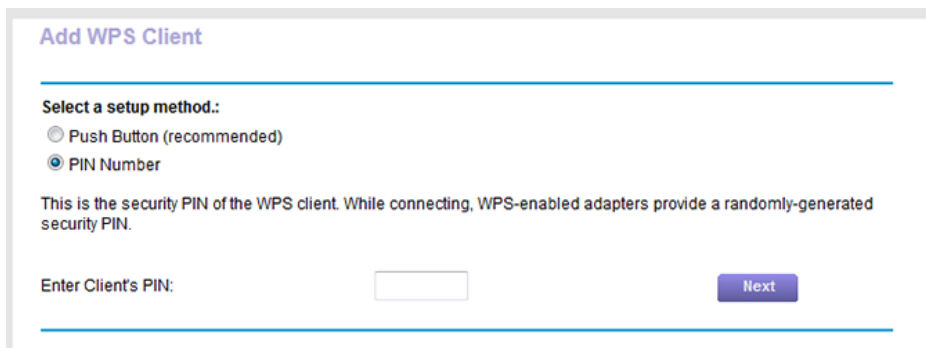

Add WPS Client

Select a setup method.:

Push Button (recommended)

PIN Number

This is the security PIN of the WPS client. While connecting, WPS-enabled adapters provide a randomly-generated security PIN.

Enter Client's PIN: **Next**

7. In the **Enter Clients' PIN** field, enter the PIN number of the WiFi device.
8. Click the **Next** button.
For four minutes, the modem router attempts to find the WiFi device (that is, the client) that you want to join the modem router's main WiFi network.
During this time, the WiFi LED on the top panel of the modem router blinks white.
9. Within four minutes, go to the WiFi device and use its WPS software to join the network without entering a password.
After the modem router establishes a WPS connection, the WiFi LED lights solid white and the Add WPS Client page displays a confirmation message.
10. To verify that the WiFi device is connected to the modem router's main WiFi network, select **BASIC > Attached Devices**.
The WiFi device displays onscreen.

Manage the Basic WiFi Settings and WiFi Security of the Guest Network

A guest network allows visitors to use the Internet without using your WiFi security key. By default, the guest WiFi network is disabled. You can enable and configure the guest WiFi network for each WiFi band. The modem router simultaneously supports the 2.4 GHz band for 802.11n, 802.11g, and 802.11b devices and the 5 GHz band for 802.11ac, 802.11n, and 802.11a devices.

The WiFi mode of the guest WiFi network depends on the WiFi mode of the main WiFi network. For example, if you configure the WiFi mode for the main WiFi network as Up to 54 Mbps in the 2.4 GHz band, the guest WiFi network also functions in the Up to 54 Mbps mode in the 2.4 GHz band. For information about configuring the WiFi mode, see [View or Change the Basic WiFi Settings](#) on page 93.

The modem router provides two default guest networks with the following names (SSIDs):

- **2.4 GHz band.** NETGEAR-Guest
- **5 GHz band.** NETGEAR-5G-Guest

By default, these networks are configured as open networks without security but are disabled. You can enable one or both networks. You can also change the SSIDs for these networks.

► To set up a guest network:

1. Launch a web browser from a computer or WiFi device that is connected to the network.
2. Enter **http://www.routerlogin.net**.
A login window opens.
3. Enter the modem router user name and password.
The user name is **admin**. The default password is **password**. The user name and password are case-sensitive.
The BASIC Home page displays.

4. Select **Guest Network**.

Guest Network Settings

Wireless Settings(2.4GHz b/g/n)

Enable Guest Network

Enable SSID Broadcast

Allow guests to see each other and access my local network

Guest Wireless Network Name (SSID):

Security Options

None

WPA2-PSK [AES]

WPA-PSK [TKIP] + WPA2-PSK [AES]

WPAWPA2 Enterprise

Wireless Settings (5GHz 802.11a/n/ac)

Enable Guest Network

Enable SSID Broadcast

Allow guests to see each other and access my local network

Guest Wireless Network Name (SSID):

Security Options

None

WPA2-PSK [AES]

WPA-PSK [TKIP] + WPA2-PSK [AES]

WPAWPA2 Enterprise

5. Enable the guest network and configure its WiFi settings as described in the following table.

Field	Description
Wireless Network (2.4GHz b/g/n)	
Enable Guest Network	By default, the guest WiFi network is disabled. To enable the guest WiFi network for the 2.4 GHz WiFi band, select the Enable Guest Network check box.
Enable SSID Broadcast	By default, the modem router broadcasts its SSID of the 2.4 GHz WiFi band so that WiFi stations can detect the WiFi name (SSID) in their scanned network lists. To turn off the SSID broadcast for the 2.4 GHz WiFi band for the guest WiFi network, clear the Enable SSID Broadcast check box.
Allow guests to see each other and access my local network	By default, WiFi clients that are connected to the 2.4 GHz WiFi band of the guest WiFi network cannot access WiFi devices or Ethernet devices that are connected to the main WiFi network. To allow access to the main WiFi network, select the Allow guests to see each other and access my local network check box.
Guest Wireless Network Name (SSID)	The SSID is the 2.4 GHz WiFi band name. If you did not change the SSID, the default SSID displays, which is NETGEAR-Guest. To change the SSID in the 2.4 GHz WiFi band for the guest WiFi network, enter a 32-character (maximum), case-sensitive name in this field.
Security Options	

Nighthawk X4S AC2600 WiFi VDSL/ADSL Modem Router Model D7800

(Continued)

Field	Description
<p>If you want to change the WiFi security, select one of the following WiFi security options for the 2.4 GHz band of the guest WiFi network:</p> <ul style="list-style-type: none"> • None. An open WiFi network that does not provide any security. Any WiFi device can join the 2.4 GHz band of the guest WiFi network. This is the default setting for the guest WiFi network. • WEP. Wired Equivalent Privacy (WEP) security is a legacy authentication and data encryption mode that is superseded by WPA-PSK and WPA2-PSK. The WEP option displays only if you configure the WiFi mode for the main WiFi network as Up to 54 Mbps in the 2.4 GHz band (see View or Change the Basic WiFi Settings on page 93). For information about configuring WEP, see Configure WEP Legacy WiFi Security on page 100. • WPA2-PSK [AES]. WPA2 provides a secure and fast connection but some older WiFi devices do not detect WPA2 and support only WPA. Select WPA2-PSK [AES] security to allow 802.11n devices to connect to the 2.4 GHz band of the guest WiFi network at the fastest speed. If your network includes older devices that do not support WPA2, select WPA-PSK [TKIP] + WPA2-PSK [AES] security. To use WPA2 security, in the Passphrase field, enter a phrase of 8 to 63 characters. To join the 2.4 GHz band of the guest WiFi network, a user must enter this passphrase. • WPA-PSK [TKIP] + WPA2-PSK [AES]. This type of security enables WiFi devices that support either WPA or WPA2 to join the 2.4 GHz band of the guest WiFi network. However, WPA-PSK [TKIP] is less secure than WPA2-PSK [AES] and limits the speed of WiFi devices to 54 Mbps. To use WPA + WPA2 security, in the Passphrase field, enter a phrase of 8 to 63 characters. To join the 2.4 GHz band of the guest WiFi network, a user must enter this passphrase. • WPA/WPA2 Enterprise. This type of security requires that your WiFi network can access a RADIUS server. For information about configuring WPA/WPA2 Enterprise, see Configure WPA/WPA2 Enterprise WiFi Security on page 99. 	
Passphrase	The passphrase that provides users access to the guest WiFi network in the 2.4 GHz band. The passphrase is also referred to as the <i>password</i> or <i>key</i> .
Wireless Network (5GHz 802.11a/n/ac)	
Enable Guest Network	By default, the guest WiFi network is disabled. To enable the guest WiFi network for the 5 GHz WiFi band, select the Enable Guest Network check box.
Enable SSID Broadcast	By default, the modem router broadcasts its SSID of the 5 GHz WiFi band so that WiFi stations can detect the WiFi name (SSID) in their scanned network lists. To turn off the SSID broadcast for the 5 GHz WiFi band for the guest WiFi network, clear the Enable SSID Broadcast check box.
Allow guests to see each other and access my local network	By default, WiFi clients that are connected to the 5 GHz WiFi band of the guest WiFi network cannot access WiFi devices or Ethernet devices that are connected to the main WiFi network. To allow access to the main WiFi network, select the Allow guests to see each other and access my local network check box.
Guest Wireless Network Name (SSID)	The SSID is the 5 GHz WiFi band name. If you did not change the SSID, the default SSID displays, which is NETGEAR-5G-Guest. To change the SSID in the 5 GHz WiFi band for the guest WiFi network, enter a 32-character (maximum), case-sensitive name in this field.
Security Options	

(Continued)

Field	Description
<p>If you want to change the WiFi security, select one of the following WiFi security options for the 5 GHz band of the guest WiFi network:</p> <ul style="list-style-type: none"> • None. An open WiFi network that does not provide any security. Any WiFi device can join the 5 GHz band of the guest WiFi network. This is the default setting for the guest WiFi network. • WPA2-PSK [AES]. WPA2 provides a secure and fast connection but some older WiFi devices do not detect WPA2 and support only WPA. Select WPA2-PSK [AES] security to allow 802.11ac and 802.11n devices to connect to the 5 GHz band of the guest WiFi network at the fastest speed. If your network includes older devices that do not support WPA2, select WPA-PSK [TKIP] + WPA2-PSK [AES] security. To use WPA2 security, in the Passphrase field, enter a phrase of 8 to 63 characters. To join the 5 GHz band of the guest WiFi network, a user must enter this passphrase. • WPA-PSK [TKIP] + WPA2-PSK [AES]. This type of security enables WiFi devices that support either WPA or WPA2 to join the 5 GHz band of the guest WiFi network. However, WPA-PSK [TKIP] is less secure than WPA2-PSK [AES] and limits the speed of WiFi devices to 54 Mbps. To use WPA + WPA2 security, in the Passphrase field, enter a phrase of 8 to 63 characters. To join the 5 GHz band of the guest WiFi network, a user must enter this passphrase. • WPA/WPA2 Enterprise. This type of security requires that your WiFi network can access a RADIUS server. For information about configuring WPA/WPA2 Enterprise, see Configure WPA/WPA2 Enterprise WiFi Security on page 99. 	
Passphrase	The passphrase that provides users access to the guest WiFi network in the 5 GHz band. The passphrase is also referred to as the <i>password</i> or <i>key</i> .

6. Click the **Apply** button.

Your settings are saved.

7. Make sure that you can reconnect over WiFi to the guest network.

If you cannot connect over WiFi, check the following:

- If your computer or WiFi device is already connected to another WiFi network in your area, disconnect it from that WiFi network and connect it to the WiFi network that the modem router provides. Some WiFi devices automatically connect to the first open network without WiFi security that they discover.
- Does your WiFi device display as an attached device? (See [View Devices Currently on the Network](#) on page 218.) If it does, it is connected to the network.
- Are you using the correct network name (SSID) and password?

Control the WiFi Radios

The modem router provides internal WiFi radios that broadcast signals in the 2.4 GHz and 5 GHz ranges. By default, they are on so that you can connect over WiFi to the modem router. When the WiFi radios are off, you can still use an Ethernet cable for a LAN connection to the modem router.

You can turn the WiFi radios on and off with the **WiFi On/Off** button on the modem router, or you can log in to the modem router and enable or disable the WiFi radios through the modem router web pages. If you are close to the modem router, it might be easier to press the **WiFi On/Off** button. If you are away from the modem router or already logged in, it might be easier to enable or disable the radios through the modem

router web pages. You can also turn the WiFi radios off and on based on a schedule. (See [Set Up a WiFi Schedule](#) on page 229.)

Use the WiFi On/Off Button

► To turn the WiFi radios off and on with the WiFi On/Off button:

- Press the **WiFi On/Off** button on the top panel of the modem router for two seconds. If you turned off the WiFi radios, the 2.4 GHz WiFi LED, 5 GHz WiFi LED, WiFi LED, and WPS LED turn off. If you turned on the WiFi radios, these LEDs lights solid white.

Tip If you want to disable the WiFi radio or radios of the modem router, use a wired connection to avoid being disconnected when WiFi radio or radios turn off.

Enable or Disable the WiFi Radios

If you used the **WiFi On/Off** button to turn off the WiFi radios, you cannot log in to the modem router to turn them back on. You must press the **WiFi On/Off** button again for two seconds to turn the WiFi radios back on.

► To enable or disable the WiFi radios:

1. Launch a web browser from a computer or WiFi device that is connected to the network.
2. Enter **http://www.routerlogin.net**.
A login window opens.
3. Enter the modem router user name and password.
The user name is **admin**. The default password is **password**. The user name and password are case-sensitive.
The BASIC Home page displays.

4. Select **ADVANCED > Advanced Setup > Wireless Settings**.

Advanced Wireless Settings

Advanced Wireless Settings (2.4GHz b/g/n)

Enable Wireless Router Radio

Enable 20/40 MHz Coexistence

CTS/RTS Threshold (1-2347)

Preamble Mode

Transmit Power Control

Turn off wireless signal by schedule

The wireless signal is scheduled to turn off during the following time period:

Period	Start	End	Recurrence Pattern
--------	-------	-----	--------------------

Advanced Wireless Settings (5GHz 802.11a/n/ac)

Enable Wireless Router Radio

CTS/RTS Threshold (1-2347)

Preamble Mode

Transmit Power Control

Turn off wireless signal by schedule

The wireless signal is scheduled to turn off during the following time period:

Period	Start	End	Recurrence Pattern
--------	-------	-----	--------------------

5. Do one of the following in the Advanced Wireless Settings (2.4GHz b/g/n) section, Advanced Wireless Settings (5GHz 802.11a/n/ac) section, or both sections:
 - **Turn off the radio.** Clear the **Enable Wireless Router Radio** check box.
The 2.4 GHz WiFi LED, 5 GHz WiFi LED, WiFi LED, and WPS LED turn off.
 - **Turn on the radio.** Select the **Enable Wireless Router Radio** check box.
The 2.4 GHz WiFi LED, 5 GHz WiFi LED, WiFi LED, and WPS LED lights solid white.
6. Click the **Apply** button.
Your settings are saved.

The modem router comes with a built-in firewall that helps protect your home network from unwanted intrusions from the Internet.

This chapter includes the following sections:

- [Set Up Parental Controls](#) on page 112
- [Allow or Block Access to Your Network](#) on page 113
- [Use Keywords to Block Internet Sites](#) on page 118
- [Manage Simple Outbound Firewall Rules for Services and Applications](#) on page 122
- [Set Up a Schedule for Keyword Blocking and Outbound Firewall Rules](#) on page 127
- [Set Up Security Event Email Notifications](#) on page 129

For information about more advanced ways to configure Internet security, see [Manage Port Forwarding and Port Triggering](#) on page 248.

Set Up Parental Controls

The first time that you select **Parental Controls** from the BASIC Home page, your browser goes to the *Parental Controls* website. You can learn more about parental controls or download the application.

After you set up and enable parental controls, you can change the web filtering level for each device on the network through the network map page on the genie app.

► To set up parental controls:

1. Launch a web browser from a computer or mobile device that is connected to the network.
2. Enter **http://www.routerlogin.net**.
A login window opens.
3. Enter the modem router user name and password.
The user name is **admin**. The default password is **password**. The user name and password are case-sensitive.
The BASIC Home page displays.
4. Select **Parental Controls**.
The *Parental Controls* website opens.
5. Click the button for the app or version that you want to download and use.
6. Follow the onscreen instructions to download and install the genie app.
7. Open the genie app and select **Parental Controls**.
After installation, Live Parental Controls automatically starts.

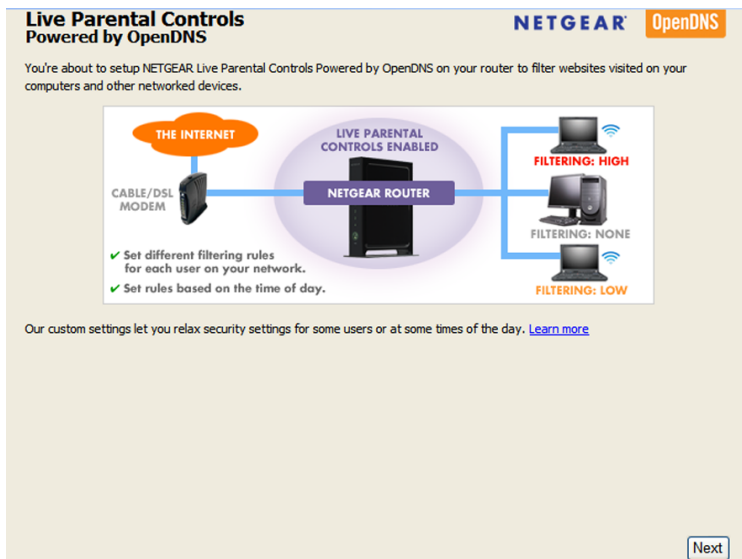

8. Click the **Next** button, read the note, and click the **Next** button again.

Nighthawk X4S AC2600 WiFi VDSL/ADSL Modem Router Model D7800

Because Live Parental Controls uses free OpenDNS accounts, you are prompted to log in or create a free account.

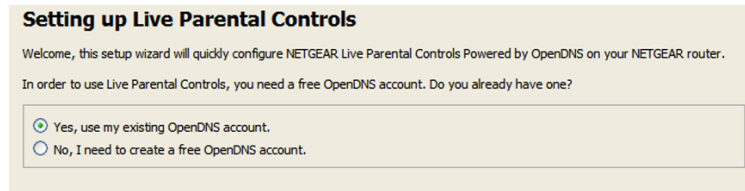

Setting up Live Parental Controls

Welcome, this setup wizard will quickly configure NETGEAR Live Parental Controls Powered by OpenDNS on your NETGEAR router.

In order to use Live Parental Controls, you need a free OpenDNS account. Do you already have one?

Yes, use my existing OpenDNS account.

No, I need to create a free OpenDNS account.

9. Select a radio button as follows:

- If you already own an OpenDNS account, leave the **Yes** radio button selected.
- If you do not own an OpenDNS account, select the **No** radio button. If you are creating an account, the Create a free OpenDNS account page displays. Do the following:
 - a.** Complete the fields.
 - b.** Click the **Next** button.

After you log on or create your account, the filtering level page displays.

10. Select the radio button for the filtering level that you want and click the **Next** button.

The Setup is complete page displays.

11. Click the **Take me to the status screen** button.

The Status page displays. Parental controls are now set up for the modem router.

12. To enable parental controls, click the **Enable Live Parental Controls** button.

After you set up and enable parental controls, you can change the web filtering level for each device on the network through the network map page of the genie app.

Allow or Block Access to Your Network

You can use access control to block or allow access of devices to your network. You define access by selecting or specifying the MAC addresses of the wired and WiFi devices that either can access your entire network or are blocked from accessing your entire network.

Enable and Manage Network Access Control

When you enable access control, you must select whether new devices are allowed to access the network or are blocked from accessing the network. By default, currently connected devices are allowed to access the network, but you can also block these devices from accessing the network.

▶ **To set up network access control:**

- 1.** Launch a web browser from a computer or mobile device that is connected to the network.
- 2.** Enter **http://www.routerlogin.net**.
A login window opens.

Nighthawk X4S AC2600 WiFi VDSL/ADSL Modem Router Model D7800

3. Enter the modem router user name and password.
The user name is **admin**. The default password is **password**. The user name and password are case-sensitive.

The BASIC Home page displays.

4. Select **ADVANCED > Security > Access Control**.

Access Control

You can use Access Control to allow or block computers or electronic devices from accessing your network.

Turn on Access Control

Access Rule: This is a general rule. You can also allow or block individual devices.

Allow all new devices to connect

Block all new devices from connecting

Status	Device Name	IP Address	MAC Address	Connection Type
<input type="checkbox"/> Allowed	BUSINESSLAPTOP	192.168.1.2	60:66:66:DA:66:7C	Wireless(NETGEAR84)
<input type="checkbox"/> Allowed	ANDROID	192.168.1.3	C0:D1:D1:B0:F0:D1	Wireless(NETGEAR84-5G)

▶ View list of allowed devices not currently connected to the network

▶ View list of blocked devices not currently connected to the network

The previous figure shows two WiFi devices connected.

5. Select the **Turn on Access Control** check box.
You must select this check box before you can specify an access rule and use the **Allow** and **Block** buttons. When the **Turn on Access Control** check box is cleared, all devices are allowed to connect, even if a device is in the list of blocked devices.
6. Click the **Apply** button.
Your settings are saved.
7. Select an access rule for new devices:
 - **Allow all new devices to connect.** With this setting, if you add a new device, it can access your network. You do not need to enter its MAC address on this page. We recommend that you leave this radio button selected.
 - **Block all new devices from connecting.** With this setting, if you add a new device, before it can access your network, you must enter its MAC address for an Ethernet connection and its MAC address for a WiFi connection in the allowed list. For more information, see [Manage Network Access Control Lists](#) on page 115.

The access rule does not affect previously blocked or allowed devices. It applies only to devices joining your network in the future after you apply these settings.

8. To manage access for currently connected computers and devices, do the following:
 - If you blocked all new devices from connecting, to allow the computer or device that you are currently using to continue to access the network, select the check box next to your computer or device in the table, and click the **Allow** button.

Nighthawk X4S AC2600 WiFi VDSL/ADSL Modem Router Model D7800

- To either continue to allow or to block other computers and devices that are currently connected, select the check box next to the computer or device in the table, and click either the **Allow** button or the **Block** button.

Access Control Cancel Apply

You can use Access Control to allow or block computers or electronic devices from accessing your network.

Turn on Access Control

Access Rule: This is a general rule. You can also allow or block individual devices.

Allow all new devices to connect

Block all new devices from connecting

Allow Block Edit Refresh

Status	Device Name	IP Address	MAC Address	Connection Type
<input checked="" type="checkbox"/> Blocked	ANDROID	192.168.1.3	C0:D1:D1:B0:F0:D1	Wireless(NETGEAR84-5G)
<input type="checkbox"/> Allowed	BUSINESSLAPTOP	192.168.1.2	60:66:66:DA:66:7C	Wireless(NETGEAR84)

▶ View list of allowed devices not currently connected to the network

▶ View list of blocked devices not currently connected to the network

- Click the **Apply** button.
Your settings are saved.

Manage Network Access Control Lists

You can use access control to block or allow access to your network. An access control list (ACL) functions with the MAC addresses of wired and WiFi devices that can either access your entire network or are blocked from accessing your entire network.

The modem router can detect the MAC addresses of devices that are connected to the network and list the MAC addresses of devices that were connected to the network.

Each network device owns a MAC address, which is a unique 12-character physical address, containing the hexadecimal characters 0–9, a–f, or A–F (uppercase or lowercase) only, and separated by colons (for example, 00:09:AB:CD:EF:01). Typically, the MAC address is on the label of the WiFi card or network interface device. If you cannot see the label, you can display the MAC address using the network configuration utilities of the computer. You might also find the MAC addresses through the web pages of the modem router (see [View Devices Currently on the Network](#) on page 218).

Add Devices to or Remove Them From the Blocked List

If you set up an access list that allows all new devices to access your network but you want to block some devices from accessing your network, you must specify the devices that you want to block.

▶ To add or remove devices that are blocked:

- Launch a web browser from a computer or mobile device that is connected to the network.
- Enter **http://www.routerlogin.net**.
A login window opens.
- Enter the modem router user name and password.

Nighthawk X4S AC2600 WiFi VDSL/ADSL Modem Router Model D7800

The user name is **admin**. The default password is **password**. The user name and password are case-sensitive.

The BASIC Home page displays.

4. Select **ADVANCED > Security > Access Control**.
The Access Control page displays.
5. Click the **View list of blocked devices not currently connected to the network** link.

Access Control

You can use Access Control to allow or block computers or electronic devices from accessing your network.

Turn on Access Control

Access Rule: This is a general rule. You can also allow or block individual devices.

Allow all new devices to connect
 Block all new devices from connecting

Status	Device Name	IP Address	MAC Address	Connection Type
<input type="checkbox"/> Allowed	BUSINESSLAPTOP	192.168.1.2	60:66:66:DA:66:7C	Wireless(NETGEAR84)

▶ View list of allowed devices not currently connected to the network
▼ View list of blocked devices not currently connected to the network

Device Name	MAC Address	Connection Type
<input type="checkbox"/> ANDROID	C0:D1:D1:B0:F0:D1	Wireless

A table displays the detected device name, MAC address, and connection type of the devices that are not connected and are blocked from accessing the network.

6. To add a device to the blocked list, do the following:
 - a. Click the **Add** button.
The Add Blocked Device page displays.
 - b. Enter the MAC address and device name for the device that you want to block.
 - c. On the Add Blocked Device page, click the **Apply** button.
The device is added to the blocked list on the Access Control page.
7. To remove a device from blocked list, do the following:
 - a. Select the check box for the device.
 - b. Click the **Delete** button.
The device is removed from the blocked list.
8. Click the **Apply** button.
Your settings are saved.

Add Devices to or Remove Them From the Allowed List

If you set up an access list that blocks all new devices from accessing your network, you must specify which devices are allowed to access your network.

► **To add or remove devices that are allowed:**

1. Launch a web browser from a computer or mobile device that is connected to the network.
2. Enter **http://www.routerlogin.net**.
A login window opens.
3. Enter the modem router user name and password.
The user name is **admin**. The default password is **password**. The user name and password are case-sensitive.
The BASIC Home page displays.
4. Select **ADVANCED > Security > Access Control**.
The Access Control page displays.
5. Click the **View list of allowed devices not currently connected to the network** link.

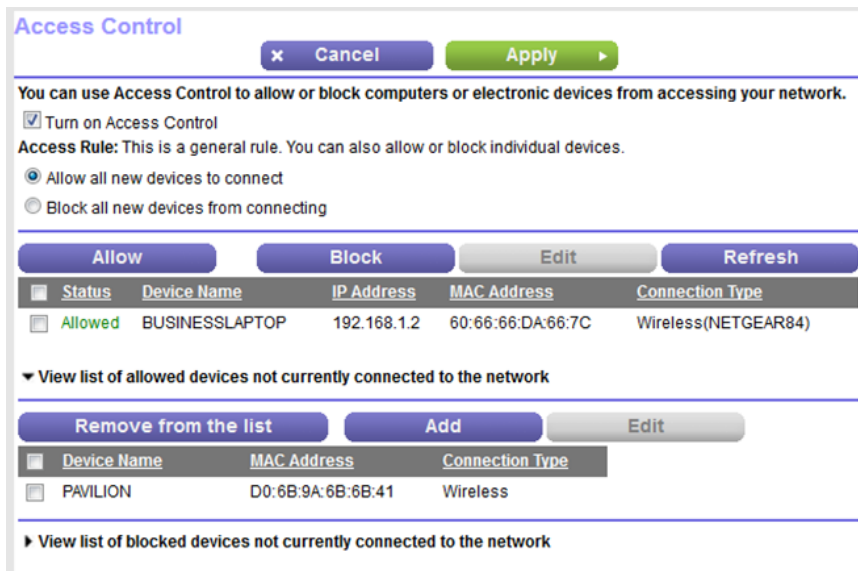

A table displays the detected device name, MAC address, and connection type of the devices that are not connected but allowed to access the network.

6. To add a device to the allowed list, do the following:
 - a. Click the **Add** button.
The Add Allowed Device page displays.
 - b. Enter the MAC address and device name for the device that you want to allow.
 - c. On the Add Allowed Device page, click the **Apply** button.
The device is added to the allowed list on the Access Control page.

7. To remove a device from allowed list, do the following:
 - a. Select the check box for the device.
 - b. Click the **Delete** button.
The device is removed from the allowed list.
8. Click the **Apply** button.
Your settings are saved.

Use Keywords to Block Internet Sites

You can block keywords and domains (websites) to prevent certain types of HTTP traffic from accessing your network. By default, keyword blocking is disabled and no domains are blocked.

Set Up Blocking

You can set up blocking of specific keywords and domains to occur continuously or according to a schedule.

▶ To set up keyword and domain blocking:

1. Launch a web browser from a computer or mobile device that is connected to the network.
2. Enter **http://www.routerlogin.net**.
A login window opens.
3. Enter the modem router user name and password.
The user name is **admin**. The default password is **password**. The user name and password are case-sensitive.
The BASIC Home page displays.

4. Select **ADVANCED > Security > Block Sites**.

The screenshot shows the 'Block Sites' configuration page. At the top, there are 'Cancel' and 'Apply' buttons. Below that is a link to a Netgear support page. The 'Keyword Blocking' section has three radio buttons: 'Never' (selected), 'Per Schedule', and 'Always'. Below this is a text input field for 'Type keyword or domain name here.' with an 'Add Keyword' button. A list box below shows 'Block sites containing these keywords or domain names:' with 'Delete Keyword' and 'Clear List' buttons. At the bottom, there is a checkbox for 'Allow trusted IP address to visit blocked sites' and a 'Trusted IP Address' field with four input boxes containing '192', '168', '1', and an empty box.

5. Specify a keyword blocking option:

- **Per Schedule.** Use keyword blocking according to a schedule that you set. For more information, see *Set Up a Schedule for Keyword Blocking and Outbound Firewall Rules* on page 127.
- **Always.** Use keyword blocking continuously.

6. In the **Type keyword or domain name here** field, enter a keyword or domain.

Here are some sample entries:

- Specify XXX to block `http://www.badstuff.com/xxx.html`.
- Specify `.com` if you want to allow only sites with domain suffixes such as `.edu` or `.gov`.
- Enter a period (`.`) to block all Internet browsing access.

7. Click the **Add Keyword** button.

The keyword or domain is added to the **Block sites containing these keywords or domain names** field (which is also referred to as the blocked list).

8. To add more keywords or domains, repeat Step 6 and Step 7.

The keyword list supports up to 32 entries.

9. Click the **Apply** button.

Your settings are saved.

Remove a Keyword or Domain From the Blocked List

If you no longer need a keyword or domain on the blocked list, you can remove the keyword or domain.

► To remove a keyword or domain from the blocked list:

1. Launch a web browser from a computer or mobile device that is connected to the network.
2. Enter **http://www.routerlogin.net**.
A login window opens.
3. Enter the modem router user name and password.
The user name is **admin**. The default password is **password**. The user name and password are case-sensitive.
The BASIC Home page displays.
4. Select **ADVANCED > Security > Block Sites**.
The Block Sites page displays.
5. In the **Block sites containing these keywords or domain names** field, select the keyword or domain.
6. Click the **Delete Keyword** button.
The keyword or domain is removed from the blocked list.
7. Click the **Apply** button.
Your settings are saved.

Remove All Keywords and Domains From the Blocked List

You can simultaneously remove all keywords and domains from the blocked list.

► To remove all keywords and domains from the blocked list:

1. Launch a web browser from a computer or mobile device that is connected to the network.
2. Enter **http://www.routerlogin.net**.
A login window opens.
3. Enter the modem router user name and password.
The user name is **admin**. The default password is **password**. The user name and password are case-sensitive.
The BASIC Home page displays.
4. Select **ADVANCED > Security > Block Sites**.
The Block Sites page displays.
5. Click the **Clear List** button.
All keywords and domains are removed from the blocked list.
6. Click the **Apply** button.
Your settings are saved.

Specify a Trusted Computer

You can exempt one trusted device from blocking and logging. The device that you exempt must be assigned a fixed (static) IP address.

► To specify a trusted device:

1. Launch a web browser from a computer or mobile device that is connected to the network.
2. Enter **http://www.routerlogin.net**.
A login window opens.
3. Enter the modem router user name and password.
The user name is **admin**. The default password is **password**. The user name and password are case-sensitive.
The BASIC Home page displays.
4. Select **ADVANCED > Security > Block Sites**.

5. Scroll down and select the **Allow trusted IP address to visit blocked sites** check box.
6. In the **Trusted IP Address** field, enter the IP address of the trusted device.
The first three octets of the IP address are automatically populated and depend on the IP address that is assigned to the modem router on the LAN Setup page.
7. Click the **Apply** button.
Your settings are saved.

Manage Simple Outbound Firewall Rules for Services and Applications

A firewall protects one network (the trusted network, such as your LAN) from another (the untrusted network, such as the Internet), while allowing communication between the two.

The modem router provides one default outbound firewall rule: It allows all access to the Internet (that is, the WAN). You can add simple rules to prevent access to specific services and applications on the Internet. In addition, you can specify if a rule applies to one user, a range of users, or all users on your LAN.

The modem router lists many default services and applications that you can use in outbound rules. You can also add an outbound firewall rule for a custom service or application.

For information about blocking specific keywords, URLs, or sites, see *Use Keywords to Block Internet Sites* on page 118. This type of blocking is another aspect of the outbound firewall. For information about inbound firewall rules, see *Manage Port Forwarding and Port Triggering* on page 248.

Note Service blocking means the same thing as applying outbound firewall rules.

Add an Outbound Firewall Rule

You can add an outbound firewall rule to prevent access to a specific service or application on the Internet.

► To add an outbound firewall rule:

1. Launch a web browser from a computer or mobile device that is connected to the network.
2. Enter **http://www.routerlogin.net**.
A login window opens.
3. Enter the modem router user name and password.
The user name is **admin**. The default password is **password**. The user name and password are case-sensitive.
The BASIC Home page displays.
4. Select **ADVANCED > Security > Block Services**.

5. In the Services Blocking section, specify how the modem router applies outbound rules:

Nighthawk X4S AC2600 WiFi VDSL/ADSL Modem Router Model D7800

- **Per Schedule.** Use keyword blocking according to a schedule that you set.
For more information, see [Set Up a Schedule for Keyword Blocking and Outbound Firewall Rules](#) on page 127.
- **Always.** Use keyword blocking continuously.

6. Below the Service Table, click the **Add** button.

7. From the **Service Type** menu, select service or application to be covered by this rule.
If the service or application does not display in the list, you can add it (see [Add an Outbound Firewall Rule for a Custom Service or Application](#) on page 124).
8. Specify which devices on your LAN are affected by the rule, based on their IP addresses:
 - **Only This IP Address.** Enter the required address in the fields to apply the rule to a single device on your LAN.
 - **IP Address Range.** Enter the required addresses in the start and end fields to apply the rule to a range of devices.
 - **All IP Addresses.** All computers and devices on your LAN are covered by this rule.
By default, the **All IP Addresses** radio button is selected.
9. Click the **Add** button.
The new rule is added to the Service Table on the Block Services page.

Add an Outbound Firewall Rule for a Custom Service or Application

The modem router lists many default services and applications that you can use in outbound rules. If the service or application is not predefined, you can specify a custom service or application in an outbound rule.

► To add an outbound firewall rule for a custom service or application:

1. Find out which protocol and port number or range of numbers the service or application uses.
You can usually find this information by contacting the publisher of the service or application or through online user or news groups.
2. Launch a web browser from a computer or mobile device that is connected to the network.
3. Enter **http://www.routerlogin.net**.
A login window opens.
4. Enter modem router the user name and password.
The user name is **admin**. The default password is **password**. The user name and password are case-sensitive.
The BASIC Home page displays.
5. Select **ADVANCED > Security > Block Services**.

Block Services

Services Blocking

Never
 Per Schedule
 Always

Service Table

#	Service Type	Port	IP
---	--------------	------	----

6. If this is the first time that you add an outbound firewall rule, in the Services Blocking section, specify how the modem router applies outbound rules:
 - **Per Schedule.** Use keyword blocking according to a schedule that you set.
For more information, see [Set Up a Schedule for Keyword Blocking and Outbound Firewall Rules](#) on page 127.
 - **Always.** Use keyword blocking continuously.

- Below the Service Table, click the **Add** button.

- From the **Service Type** menu, select **User Defined**.
- Specify a new outbound rule as described in the following table.

Field	Description
Protocol	Select the protocol (TCP or UDP) that is associated with the service or application. If you are unsure, select TCP/UDP .
Starting Port	Enter the start port for the service or application.
Ending Port	If the service or application uses a range of ports, enter the end port for the range. If the service or application uses a single port, repeat the port number that you entered in the Starting Port field.
Service Type/User Defined	Enter the name of the custom service or application.

- Specify which devices on your LAN are affected by the rule, based on their IP addresses:
 - Only This IP Address.** Enter the required address in the fields to apply the rule to a single device on your LAN.
 - IP Address Range.** Enter the required addresses in the start and end fields to apply the rule to a range of devices.
 - All IP Addresses.** All computers and devices on your LAN are covered by this rule. By default, the **All IP Addresses** radio button is selected.
- Click the **Add** button.
The new rule is added to the Service Table on the Block Services page.

Change an Outbound Firewall Rule

You can change an existing outbound firewall rule.

► To change an outbound firewall rule:

1. Launch a web browser from a computer or mobile device that is connected to the network.
2. Enter **http://www.routerlogin.net**.
A login window opens.
3. Enter the modem router user name and password.
The user name is **admin**. The default password is **password**. The user name and password are case-sensitive.
The BASIC Home page displays.
4. Select **ADVANCED > Security > Block Services**.

Block Services

Services Blocking

Never
 Per Schedule
 Always

Service Table

	#	Service Type	Port	IP
<input checked="" type="radio"/>	1	Age-of-Empire	47624-47624	all
<input type="radio"/>	2	Quakell/III	27960-27960	192.168.1.100-192.168.1.199

The previous figure shows two rules in the Service Table.

5. In the Service Table, select the radio button for the rule.
6. Click the **Edit** button.
The Block Services Setup page displays.
7. Change the settings.
For more information about the settings, see [Add an Outbound Firewall Rule for a Custom Service or Application](#) on page 124.
8. Click the **Accept** button.
Your settings are saved. The changed rule displays in the Service Table on the Block Services page.

Remove an Outbound Firewall Rule

You can remove an outbound firewall rule that you no longer need.

► To remove an outbound firewall rule:

1. Launch a web browser from a computer or mobile device that is connected to the network.
2. Enter **http://www.routerlogin.net**.
A login window opens.
3. Enter the modem router user name and password.
The user name is **admin**. The default password is **password**. The user name and password are case-sensitive.
The BASIC Home page displays.
4. Select **ADVANCED > Security > Block Services**.

Block Services

Services Blocking

Never

Per Schedule

Always

Service Table

#	Service Type	Port	IP
<input checked="" type="radio"/> 1	Age-of-Empire	47624-47624	all
<input type="radio"/> 2	Quakell/III	27960-27960	192.168.1.100-192.168.1.199

The previous figure shows two rules in the Service Table.

5. In the Service Table, select the radio button for the rule.
6. Click the **Delete** button.
The rule is removed from the Service Table.

Set Up a Schedule for Keyword Blocking and Outbound Firewall Rules

You can set up a schedule that you can apply to keyword blocking and outbound firewall rules.

The schedule can specify the days and times that these features are active. After you set up the schedule, if you want it to become active, you must apply it to keyword blocking (see *Use Keywords to Block Internet Sites* on page 118), outbound firewall rules (see *Manage Simple Outbound Firewall Rules for Services and Applications* on page 122), or both. Without a schedule, you can only enable or disable these features. By default, no schedule is set.

► To set up a schedule:

1. Launch a web browser from a computer or mobile device that is connected to the network.
2. Enter **http://www.routerlogin.net**.
A login window opens.
3. Enter the modem router user name and password.
The user name is **admin**. The default password is **password**. The user name and password are case-sensitive.
The BASIC Home page displays.
4. Select **ADVANCED > Security > Schedule**.

The screenshot shows the 'Schedule' configuration page. At the top, there are 'Cancel' and 'Apply' buttons. Below this, the 'Days to Block' section has checkboxes for 'Every Day', 'Sunday', 'Monday', 'Tuesday', 'Wednesday', 'Thursday', 'Friday', and 'Saturday', all of which are checked. The 'Time of day to block' section has an 'All Day' checkbox checked, and 'Start Blocking' and 'End Blocking' fields set to 0 Hour 0 Minute and 24 Hour 0 Minute respectively. The 'Time Zone' dropdown is set to '(GMT-08:00) Pacific Time (US & Canada): Tijuana', and the 'Automatically adjust for daylight savings time' checkbox is checked. At the bottom, the current time is displayed as 'Friday, 20 Mar 2015 05:29:14'.

5. Set up the schedule for blocking:
 - **Days to Block.** Select the check box for each day that you want to block access or specify that blocking occurs on every day by selecting the **Every Day** check box. By default, the **Every Day** check box is selected.
 - **Time of Day to Block.** Select a start and end time for blocking in 24-hour format or select the **All Day** check box for 24-hour blocking. By default, the **All Day** check box is selected.
6. From the **Time Zone** menu, select your time zone.
7. If you live in an area that observes daylight saving time, select the **Automatically adjust for daylight savings time** check box.

Note If the modem router synchronized its internal clock with a time server on the Internet and you selected the correct time zone, the **Current Time** field displays the correct date and time.

8. Click the **Apply** button.
Your settings are saved.

Set Up Security Event Email Notifications

The modem router can email you its logs of its activity. The log records router activity and security events such as attempts to access blocked sites or services.

► To set up email notifications:

1. Launch a web browser from a computer or WiFi device that is connected to the network.
2. Enter **http://www.routerlogin.net**.
A login window opens.
3. Enter the modem router user name and password.
The user name is **admin**. The default password is **password**. The user name and password are case-sensitive.
The BASIC Home page displays.
4. Select **ADVANCED > Security > E-mail**.

The screenshot shows the 'E-mail' configuration page. At the top, there are 'Cancel' and 'Apply' buttons. Below is a section for 'Turn E-mail Notification On' with a checked checkbox. Underneath, there's a section for 'Send alerts and logs through e-mail' with fields for 'Primary E-mail Address', 'Your Outgoing Mail Server', and 'Outgoing Mail Server Port Number' (set to 25). There's also a checkbox for 'My mail server requires authentication' and fields for 'User Name' and 'Password'. A section for 'Send Alert Immediately' has a checkbox and the text 'When someone attempts to visit a blocked site'. Finally, there's a section for 'Send logs according to this schedule' with a dropdown for 'When log is full', a dropdown for 'Day' (set to Sunday), and a dropdown for 'Time' (set to 0:00) with radio buttons for 'a.m.' and 'p.m.'.

5. Select the **Turn Email Notification On** check box.
6. Enter the settings as described in the following table.

Nighthawk X4S AC2600 WiFi VDSL/ADSL Modem Router Model D7800

Field	Description
Send alerts and logs through e-mail	
Your Outgoing Mail Server	Enter the name of your ISP's outgoing (SMTP) mail server (such as mail.myISP.com). You might be able to find this information in the configuration window of your email program. If you leave this field blank, log and alert messages are not sent.
Send to This E-mail Address	Enter the email address to which logs and alerts must be sent.
Secure connection (use SSL)	Select this check box to send messages over a secure connection.
My mail server requires authentication	If your outgoing email server requires authentication, select this check box and specify the following settings: <ul style="list-style-type: none"> • In the User Name field, enter the user name for the outgoing email server. • In the Password field, enter the password for the outgoing email server.
Send Alert Immediately	
Send Alert Immediately When someone attempts to visit a blocked site	Select this check box to enable the modem router to send an email alert immediately when someone attempts to visit a blocked site.
Send logs according to this schedule	
To send logs based on a schedule, select one of the following options from the menu: <ul style="list-style-type: none"> • When log is full. This is the default selection. • Hourly. Logs are sent every hour. • Daily. Logs are sent every day. From the Time menu, specify the time of day, and select the am or pm radio button. • Weekly. Logs are sent every week. From the Day menu, select the day. From the Time menu, specify the time of day, and select the am or pm radio button. If you do not want logs to be sent at all, select None from the menu. 	

7. Click the **Apply** button.

Your settings are saved.

Logs are sent automatically. If the log fills before the specified time, it is sent. After the log is sent, it is cleared from the modem router memory. If the modem router cannot email the log and the log buffer fills, the modem router overwrites the log.

This chapter describes how you can optimize the modem router's performance and manage the traffic flows through the modem router.

The chapter contains the following sections:

- *Use Dynamic QoS to Optimize Internet Traffic Management* on page 132
- *Manage Wi-Fi Multimedia Quality of Service* on page 136
- *Manage Beamforming* on page 137
- *Improve Network Connections With Universal Plug-N-Play* on page 138

Use Dynamic QoS to Optimize Internet Traffic Management

Dynamic Quality of Service (QoS) helps improve your router's Internet traffic management capabilities through better application and device identification, bandwidth allocation, and traffic prioritization techniques. Dynamic QoS resolves traffic congestion when the Internet bandwidth is limited and different demands compete for bandwidth.

If your Internet download and upload speed is 250 Mbps or less and you like gaming and streaming video, then you can benefit from enabling Dynamic QoS.

Note If you use a Gigabit Internet connection, or your Internet download and upload speed is 300 Mbps or faster, then you don't need to use Dynamic QoS.

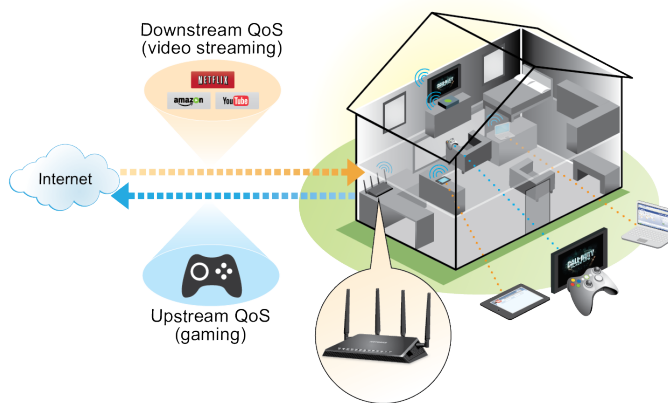

Figure 9. Dynamic QoS optimizes Internet traffic by prioritizing competing demands

Enable Dynamic QoS

Because not everyone uses Dynamic QoS, it is disabled by default.

► **To enable Dynamic QoS:**

1. Launch a web browser from a computer or WiFi device that is connected to the network.
2. Enter **<http://www.routerlogin.net>**.
A login window opens.
3. Enter the modem router user name and password.
The user name is **admin**. The default password is **password**. The user name and password are case-sensitive.
The BASIC Home page displays.

4. Select **Quality of Service**.

QoS Setup

Cancel Apply

Dynamic QoS: Automatic traffic prioritization by application and device

QoS does not increase your total Internet bandwidth or WiFi throughput.

Internet Bandwidth

Let Speedtest detect my Internet bandwidth (recommended)

DOWNLOAD SPEED Mbps UPLOAD SPEED Mbps

Speedtest

I want to define my Internet bandwidth

Performance Optimization Database

Automatically update performance optimization database Update Now

Current Performance Optimization Database on Router

Version: v2.0330.g60029a7

Release Date: March 30, 2015

Help improve the Quality of Service feature by sharing analytics with NETGEAR

[Click here to learn more about how we collect, use and share analytics information](#)

5. Specify your Internet bandwidth.

You must specify your Internet bandwidth so that Dynamic QoS can perform bandwidth allocation and traffic prioritization.

To allow Speedtest to detect your Internet bandwidth (recommended), do the following:

- a. For more accurate Speedtest results, make sure that no other devices are accessing the Internet.
- b. Click the **Speedtest** button.
Speedtest determines your Internet bandwidth.

6. Click the **Apply** button.

Your settings are saved.

A link to the Attached Devices page displays at the bottom of the page. Click the link to view bandwidth utilization. For more information, see *View Devices Currently on the Network* on page 218.

Enable or Disable the Automatic QoS Database Update

The modem router uses a QoS database of the most popular applications and services to implement Dynamic QoS. By default, the modem router automatically updates this database. You can turn off this feature and manually update the database.

► To enable or disable the automatic Dynamic QoS database update:

1. Launch a web browser from a computer or WiFi device that is connected to the network.
2. Enter **http://www.routerlogin.net**.
A login window opens.

Nighthawk X4S AC2600 WiFi VDSL/ADSL Modem Router Model D7800

3. Enter the modem router user name and password.
The user name is **admin**. The default password is **password**. The user name and password are case-sensitive.
The BASIC Home page displays.
4. Select **Quality of Service**.

QoS Setup

Cancel Apply

Dynamic QoS: Automatic traffic prioritization by application and device

QoS does not increase your total Internet bandwidth or WiFi throughput.

Internet Bandwidth

Let Speedtest detect my Internet bandwidth (recommended)

DOWNLOAD SPEED Mbps UPLOAD SPEED Mbps

Speedtest

I want to define my Internet bandwidth

Performance Optimization Database

Automatically update performance optimization database Update Now

Current Performance Optimization Database on Router

Version: v2.0330.g60029a7

Release Date: March 30, 2015

Help improve the Quality of Service feature by sharing analytics with NETGEAR

[Click here to learn more about how we collect, use and share analytics information](#)

If you are using Dynamic QoS, the **Dynamic QoS** check box is selected.

5. Select or clear the **Automatically update performance optimization database** check box.
6. Click the **Apply** button.
Your settings are saved.

Manually Update the Dynamic QoS Database

The modem router uses a QoS database of the most popular applications and services to implement Dynamic QoS. By default, the modem router automatically updates this database when you enable Dynamic QoS, but if you turned off the automatic update feature, you can manually update the database.

► To manually update the Dynamic QoS database:

1. Launch a web browser from a computer or WiFi device that is connected to the network.
2. Enter **http://www.routerlogin.net**.
A login window opens.
3. Enter the modem router user name and password.
The user name is **admin**. The default password is **password**. The user name and password are case-sensitive.

The BASIC Home page displays.

4. Select **Quality of Service**.

The QoS Setup page displays.

If you are using Dynamic QoS, the **Dynamic QoS** check box is selected.

5. Click the **Update Now** button.

The modem router checks for the newest version of the database and downloads it.

6. Click the **Apply** button.

Your settings are saved.

Participate in Dynamic QoS Analytics

NETGEAR uses a QoS database of the most popular applications and services to implement Dynamic QoS. As new applications and services become popular, NETGEAR updates this database and automatically updates your modem router if you enabled Dynamic QoS. You can opt in to share aggregate QoS information to help improve the Dynamic QoS feature.

► To opt in to participate in Dynamic QoS analytics:

1. Launch a web browser from a computer or WiFi device that is connected to the network.

2. Enter **http://www.routerlogin.net**.

A login window opens.

3. Enter the modem router user name and password.

The user name is **admin**. The default password is **password**. The user name and password are case-sensitive.

The BASIC Home page displays.

4. Select **Quality of Service**.

QoS Setup

Dynamic QoS: Automatic traffic prioritization by application and device

QoS does not increase your total Internet bandwidth or WiFi throughput.

Internet Bandwidth

Let Speedtest detect my Internet bandwidth (recommended)

DOWNLOAD SPEED Mbps UPLOAD SPEED Mbps

I want to define my Internet bandwidth

Performance Optimization Database

Automatically update performance optimization database

Current Performance Optimization Database on Router
Version: v2.0330.g60029a7
Release Date: March 30, 2015

Help improve the Quality of Service feature by sharing analytics with NETGEAR

[Click here to learn more about how we collect, use and share analytics information](#)

If you are using Dynamic QoS, the **Dynamic QoS** check box is selected.

5. Make sure that you enabled Dynamic QoS.

For more information about enabling Dynamic QoS, see [Enable Dynamic QoS](#) on page 132.

6. Click the **Click here to learn more about how we collect, use and share analytics information** link. A pop-up window displays detailed information about sharing analytics. The **Yes** radio button is selected by default.

7. After you read the information, click the **Submit** button.

The pop-up window closes and the **Help improve the Dynamic QoS feature by sharing analytics with NETGEAR** check box is selected automatically.

8. Click the **Apply** button.

Your settings are saved.

Manage Wi-Fi Multimedia Quality of Service

Wi-Fi Multimedia Quality of Service (WMM QoS) prioritizes WiFi voice and video traffic over the WiFi link.

WMM QoS prioritizes WiFi data packets from different applications based on four access categories: voice, video, best effort, and background. For an application to receive the benefits of WMM QoS, WMM must be enabled on both the application and the client running that application. Legacy applications that do not support WMM and applications that do not require QoS are assigned to the best effort category, which receives a lower priority than voice and video.

WMM QoS is automatically enabled for the modem router. In some circumstances you might want to disable WMM.

► To manage WMM QoS:

1. Launch a web browser from a computer or WiFi device that is connected to the network.
2. Enter **http://www.routerlogin.net**.
A login window opens.
3. Enter the modem router user name and password.
The user name is **admin**. The default password is **password**. The user name and password are case-sensitive.
The BASIC Home page displays.
4. Select **ADVANCED > Setup > QoS Setup**.
The QoS Setup page displays.
5. Click the **WMM** tab.
The Quality of Service page displays.
6. Disable or enable WMM QoS by doing the following:
 - To disable WMM QoS for the 2.4 GHz radio, clear the **Enable WMM (Wi-Fi multimedia) settings (2.4GHz b/g/n)** check box.
 - To enable WMM QoS for the 2.4 GHz radio, select the **Enable WMM (Wi-Fi multimedia) settings (2.4GHz b/g/n)** check box.
By default, WMM QoS is enabled for the 2.4 GHz radio.
 - To disable WMM QoS for the 5 GHz radio, clear the **Enable WMM (Wi-Fi multimedia) settings (5GHz 802.11a/n/ac)** check box.
 - To enable WMM QoS for the 5 GHz radio, select the **Enable WMM (Wi-Fi multimedia) settings (5GHz 802.11a/n/ac)** check box.
By default, WMM QoS is enabled for the 5 GHz radio.
7. Click the **Apply** button.
Your settings are saved.

Manage Beamforming

The modem router supports beamforming to enhance the WiFi range and performance for your WiFi devices. With beamforming, when you connect to the WiFi network, the modem router actively tracks your device and directs WiFi to your device, rather than just blasting it out in all directions.

The modem router uses explicit and implicit beamforming to improve WiFi performance. Explicit beamforming requires the devices to support beamforming. (Typically, 802.11ac devices support beamforming.) Implicit beamforming means that the modem router supports beamforming even with devices that do not support beamforming.

The modem router supports implicit beamforming for both 2.4 GHz and 5 GHz devices, which means that the modem router can provide beamforming benefits of better range and performance for all WiFi devices, even older 802.11a/b/g/n devices and not just the latest WiFi devices.

Both explicit and implicit beamforming are enabled by default. Explicit beamforming is always enabled (you cannot disable it), but you can disable implicit beamforming.

► To manage beamforming:

1. Launch a web browser from a computer or WiFi device that is connected to the network.
2. Enter **http://www.routerlogin.net**.
A login window opens.
3. Enter the modem router user name and password.
The user name is **admin**. The default password is **password**. The user name and password are case-sensitive.
The BASIC Home page displays.
4. Select **ADVANCED > Advanced Setup > Wireless Settings**.
The Advanced Wireless Settings page displays.
5. Scroll to the very bottom of the page.
6. Disable or enable beamforming by doing the following:
 - To disable beamforming, clear the **Enable BEAMFORMING** check box.
 - To enable beamforming, select the **Enable BEAMFORMING** check box.
By default, implicit beamforming is enabled.
7. Click the **Apply** button.
Your settings are saved.

Improve Network Connections With Universal Plug-N-Play

Universal Plug-N-Play (UPnP) helps devices such as Internet appliances and computers access the network and connect to other devices as needed. UPnP devices can automatically discover the services from other registered UPnP devices on the network.

If you use applications such as multiplayer gaming, peer-to-peer connections, or real-time communications such as instant messaging or remote assistance, keep UPnP enabled, which it is by default.

► To manage Universal Plug-N-Play:

1. Launch a web browser from a computer or mobile device that is connected to the network.
2. Enter **http://www.routerlogin.net**.
A login window opens.
3. Enter the modem router user name and password.
The user name is **admin**. The default password is **password**. The user name and password are case-sensitive.
The BASIC Home page displays.
4. Select **ADVANCED > Advanced Setup > UPnP**.
The UPnP page displays.
5. Select the **Turn UPnP On** check box.

Nighthawk X4S AC2600 WiFi VDSL/ADSL Modem Router Model D7800

By default, this check box is selected. You can disable or enable UPnP for automatic device configuration. If the **Turn UPnP On** check box is cleared, the modem router does not allow any device to automatically control router resources, such as port forwarding.

6. Enter the advertisement period in minutes.

The advertisement period specifies how often the modem router broadcasts its UPnP information. This value can range from 1 to 1440 minutes. The default period is 30 minutes. Shorter durations ensure that control points detect current device status at the expense of more network traffic. Longer durations can compromise the freshness of the device status but can significantly reduce network traffic.

7. Enter the advertisement time to live in hops.

The time to live for the advertisement is measured in hops (steps) for each UPnP packet sent. Hops are the steps a packet takes between routers. The number of hops can range from 1 to 255. The default value for the advertisement time to live is 4 hops, which should be fine for most home networks. If you notice that some devices are not being updated or reached correctly, it might be necessary to increase this value.

8. Click the **Apply** button.

The UPnP Portmap Table displays the IP address of each UPnP device that is accessing the modem router and which ports (internal and external) that device opened. The UPnP Portmap Table also displays what type of port is open and whether that port is still active for each IP address.

9. To refresh the information in the UPnP Portmap table, click the **Refresh** button.

Share a Storage Device

7

This chapter describes how to access and manage a storage device attached to your modem router. ReadySHARE lets you access and share a USB or eSATA storage device connected to the modem router. (If your storage device uses special drivers, it is not compatible.)

Note You can use a USB port on the modem router only to connect a USB storage device such as a flash drive or hard drive or a printer. Do not connect a computer, USB modem, CD drive, or DVD drive to a modem router USB port.

The chapter includes the following sections:

- *Connect an eSATA Device to the Modem Router* on page 141
- *USB Device Requirements* on page 141
- *Connect a USB Device to the Modem Router* on page 141
- *Access a Storage Device Connected to the Modem Router* on page 142
- *Back Up Windows Computers With ReadySHARE Vault* on page 143
- *Back Up Mac Computers With Time Machine* on page 144
- *Manage Access to a Storage Device* on page 146
- *Enable FTP Access Within Your Network* on page 148
- *View Network Folders on a Device* on page 149
- *Add a Network Folder on a Storage Device* on page 151
- *Change a Network Folder, Including Read and Write Access, on a USB Drive* on page 152
- *Approve Storage Devices* on page 154
- *Safely Remove a USB Device* on page 156

Note For more information about ReadySHARE features, visit netgear.com/readystatechange.

Connect an eSATA Device to the Modem Router

You can connect an eSATA device to the eSATA port located on the right side of the modem router.

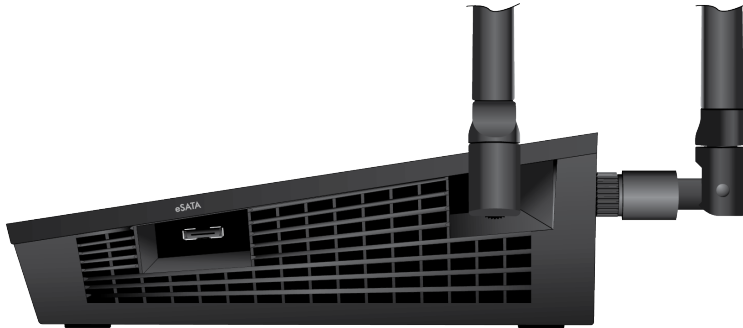

Figure 10. eSATA port

USB Device Requirements

The modem router works with most USB-compliant external flash and hard drives. For the most up-to-date list of USB devices that the modem router supports, visit kbserver.netgear.com/readyshare.

Some USB external hard drives and flash drives require you to load the drivers onto the computer before the computer can access the USB device. Such USB devices do not work with the modem router.

The modem router supports the following file system types for full read/write access:

- FAT16
- FAT32
- NTFS
- NTFS with compression format enabled
- Ext2
- Ext3
- Ext4

The modem router supports the following file system types with read-only access:

- HFS
- HFS+

Connect a USB Device to the Modem Router

ReadySHARE lets you access and share a USB device connected to a modem router USB port. (If your USB device uses special drivers, it is not compatible.)



Figure 11. Two 3.0 USB ports are located on the side of the modem router

► **To connect a USB device:**

1. Insert your USB storage drive into a USB port on the side panel of the modem router.
2. If your USB device uses a power supply, connect it.
You must use the power supply when you connect the USB device to the modem router.

When you connect the USB device to the modem router USB port, it might take up to two minutes before it is ready for sharing. By default, the USB device is available to all computers on your local area network (LAN).

Access a Storage Device Connected to the Modem Router

From a computer or device on the network, you can access a storage device that is connected to the modem router.

Access the Storage Device From a Windows-Based Computer

► **To access the storage device from a Windows-based computer:**

1. Connect a USB storage device to a USB port or an eSATA storage device to the eSATA port on the modem router.
2. If your USB device uses a power supply, connect it.
You must use the power supply when you connect the USB device to the modem router.

When you connect the storage device to the modem router's port, it might take up to two minutes before the storage device is ready for sharing. By default, the device is available to all computers on your local area network (LAN).

3. On a Windows-based computer that is connected to the network, select **Start > Run**.
4. Enter `\\readyshare` in the dialog box.
5. Click the **OK** button.

A window displays the files and folders on the device.

Access the Storage Device From a Mac

► To access the storage device from a Mac:

1. Connect a USB storage device to a USB port or an eSATA storage device to the eSATA port on the modem router.
2. If your USB device uses a power supply, connect it.
You must use the power supply when you connect the USB device to the modem router.

When you connect the storage device to the modem router's port, it might take up to two minutes before the storage device is ready for sharing. By default, the device is available to all computers on your local area network (LAN).
3. On a Mac that is connected to the network, launch Finder and select **Go > Connect to Server**.
The Connect to Server window displays.
4. In the **Server Address** field, enter **smb://readyshare**.
5. Click the **Connect** button.
6. When prompted, select the **Guest** radio button.
7. If you set up access control on the router and you allowed your Mac to access the network, select the **Registered User** radio button and enter **admin** for the name and **password** for the password.
For more information about access control, see [Allow or Block Access to Your Network](#) on page 113.
8. Click the **Connect** button.
A window displays the files and folders on the device.

Back Up Windows Computers With ReadySHARE Vault

Your modem router comes with free backup software for all the Windows computers in your home. Connect a USB hard disk drive (HDD) or an eSATA storage device to the modem router for centralized, continuous, and automatic backup.

The following operating systems support ReadySHARE Vault:

- Windows 7
- Windows 8
- Windows 8.1
- Windows 10

► To back up your Windows computer:

1. Connect a USB or eSATA storage device to the appropriate port on the modem router.
2. If your USB device uses a power supply, connect it.
You must use the power supply when you connect the USB device to the modem router.

When you connect the storage device to the modem router's port, it might take up to two minutes before it is ready for sharing. By default, the device is available to all computers on your local area network (LAN).

3. Download ReadySHARE Vault from netgear.com/readystatechange and install it on each Windows computer.
4. Launch ReadySHARE Vault.
5. Use the dashboard or the **Backup** tab to set up and run your backup.

Back Up Mac Computers With Time Machine

You can use Time Machine to back up your Mac computers onto a USB hard drive that is connected to one of the router's USB ports or an eSATA storage device connected to the router's eSATA port. You can access the connected storage device from your Mac with a wired or WiFi connection to your router.

Set Up a Storage Device on a Mac

We recommend that you use a new USB HDD or eSATA storage device, or format your old USB HDD or eSATA storage device to do the Time Machine backup for the first time. Use a blank partition to prevent some issues during backup using Time Machine. The modem router supports GUID or MBR partitions.

► To format your device and specify partitions:

1. Connect a USB or eSATA storage device to your Mac.
2. If your USB device uses a power supply, connect it.
You must use the power supply when you connect the USB device to the Mac.
3. On your Mac, open **Spotlight** (or click the magnifying glass at the top right of the page) and search for **Disk Utility**.
4. Open the Disk Utility, select your USB HDD or eSATA storage device, click the **Erase** tab, and click the **Erase** button.
5. Click the **Partition** tab.
6. In the **Partition Layout** menu, set the number of partitions that you want to use.
7. Click the **Options** button.
The Partition schemes display.
8. Select the **GUID Partition Table** or **Master Boot Record** radio button.
9. In the **Format** menu, select **Mac OS Extended (Journaled)**.
10. Click the **OK** button.
11. Click the **Apply** button.
Your settings are saved.

Prepare to Back Up a Large Amount of Data

Before you back up a large amount of data with Time Machine, we recommend that you follow this procedure.

► To prepare to back up a large amount of data:

1. Upgrade the operating system of the Mac computer.
2. Verify and repair the backup disk and the local disk.
3. Verify and repair the permissions on the local disk.
4. Set Energy Saver:
 - a. From the **Apple** menu, select **System Preferences**.
The System Preferences page displays.
 - b. Select **Energy Saver**.
The Energy Saver page displays.
 - c. Click the **Power Adapter** tab.
 - d. Select the **Wake for Wi-Fi network access** check box.
 - e. Click the **back arrow** to save the changes and exit the page.
5. Modify your security settings:
 - a. From the **System Preferences** page, select **Security & Privacy**.
The Security & Privacy page displays.
 - b. Click the **Advanced** button at the bottom of the page.
If the **Advanced** button is grayed out, click the lock icon so that you can change the settings.
 - c. Clear the **Log out after minutes of inactivity** check box.
 - d. Click the **OK** button.
Your settings are saved.

Use Time Machine to Back Up Onto a Storage Device

You can use Time Machine to back up your Mac computers onto a USB hard disk drive (HDD) that is connected to one of the modem router's USB ports or an eSATA storage device that is connected to the modem router's eSATA port.

► To back up your Mac onto a USB HDD or eSATA storage device:

1. Prepare your USB HDD or eSATA storage device with a compatible format and partitions.
For more information, see [Set Up a Storage Device on a Mac](#) on page 144.
2. If you plan to back up a large amount of data, see [Prepare to Back Up a Large Amount of Data](#) on page 144.
3. Connect your USB HDD or eSATA storage device to the appropriate port on the modem router.
4. If your USB device uses a power supply, connect it.
You must use the power supply when you connect the USB device to the modem router.

Nighthawk X4S AC2600 WiFi VDSL/ADSL Modem Router Model D7800

When you connect the storage device to the modem router's port, it might take up to two minutes before it is ready for sharing. By default, the device is available to all computers on your local area network (LAN).

5. On a Mac computer that is connected to the network, launch Finder and select **Go > Connect to Server**. The Connect to Server window displays.
6. Type **smb://routerlogin.net** and click the **Connect** button.
7. When prompted, select the **Registered User** radio button.
8. Enter **admin** for the name and **password** for the password and click the **Connect** button. A list of USB devices connected to your router displays.
9. From the **Apple** menu, select **System Preferences**. The System Preferences window displays.
10. Select **Time Machine**. The Time Machine window displays.
11. Click the **Select Backup Disk** button and select your USB device from the list.
12. Click the **Use Disk** button.

Note If you do not see the USB partition that you want in the Time Machine disk list, go to Mac Finder and click that USB partition. It displays in the Time Machine list.

13. When prompted, select the **Registered User** radio button.
14. Enter **admin** for the name and **password** for the password and click the **Connect** button. The setup is complete and the Mac automatically schedules a full backup. You can back up immediately if you want.

Manage Access to a Storage Device

You can specify the device name, workgroups, and network folders for a storage device connected to the USB port on the modem router.

► To specify the storage device access settings:

1. Launch a web browser from a WiFi-enabled computer or mobile device that is connected to the network.
2. Enter **http://www.routerlogin.net**. A login window opens.
3. Enter the modem router user name and password. The user name is **admin**. The default password is **password**. The user name and password are case-sensitive. The BASIC Home page displays.

4. Select **ADVANCED > ReadySHARE > Advanced Settings**.

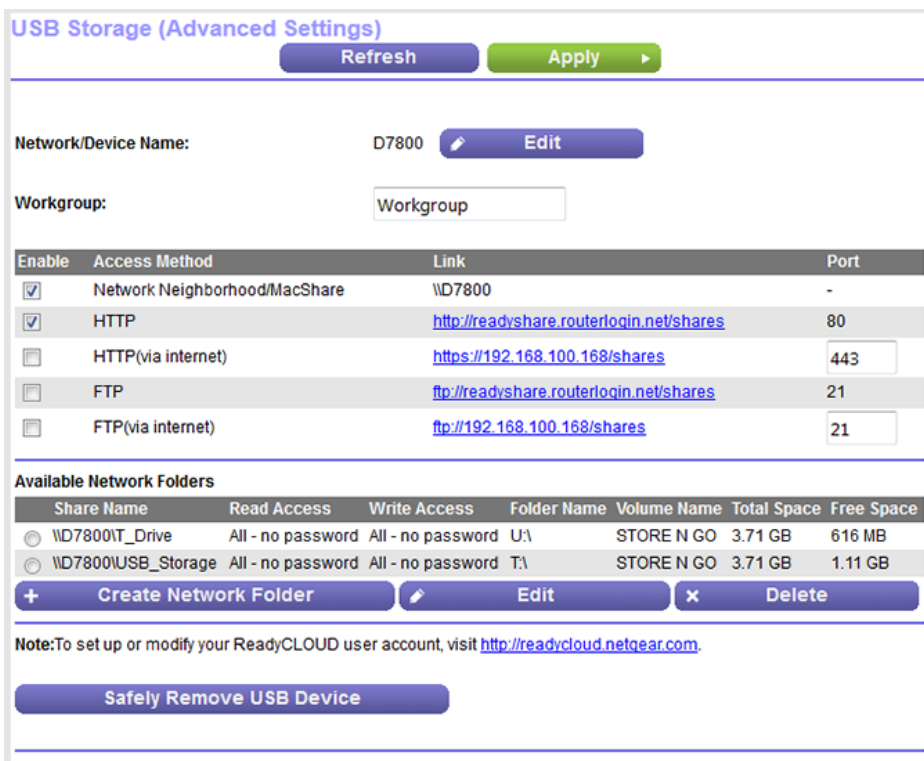

The previous figure shows two USB devices attached to the modem router.

5. To specify a name that is used to access the USB device or devices that are connected to the modem router, do the following:
 - a. Click the upper **Edit** button.
The Device Name page displays.
 - b. Type a new name in the **Device Name** field.
 - c. Click the **Apply** button.
A pop-up window displays.
 - d. Click the **Yes** button.
 - e. When the process is complete, select **ADVANCED > ReadySHARE > Advanced Settings**.
The USB Storage (Advanced Settings) page displays again.

By default, the name is readyshare.

6. To specify a name for the workgroup that the USB device or devices are members of, in the **Workgroup** field, enter a name.
By default, the name is Workgroup. The name works only in an operating system that supports NetBIOS, such as Microsoft Windows. If you are using a Windows workgroup rather than a domain, the workgroup name is displayed here.
7. Enable or disable access methods by selecting or clearing the corresponding check boxes and specifying access to the storage device as described in the following table.

Share a Storage Device

Nighthawk X4S AC2600 WiFi VDSL/ADSL Modem Router Model D7800

Access Method	Description
Network Neighborhood/MacShare	Enabled by default. You can type <code>\\readyshare</code> to access the storage device within your network. If you change the name in the Network/Device Name field from readyshare to another name, the link changes accordingly.
HTTP	Enabled by default. You can type <code>http://readyshare.routerlogin.net/shares</code> to access the USB device within your network and download or upload files. In this URL, readyshare is the name that is specified in the Network/Device Name field. If you change the name in the Network/Device Name field from readyshare to another name, the link changes accordingly. You can also click the link that is shown in the Link column. The fixed port is number is 80.
HTTPS (via internet)	Disabled by default. If you enable this feature, remote users can type <code>https://<public IP address>/shares</code> to access the USB device over the Internet. <i><public IP address></i> is the external or public IP address that is assigned to the modem router (for example, 1.1.10.102). This feature supports file uploading only. The default port is number 443, which you can change.
FTP	Enabled by default. You can type <code>ftp://readyshare.routerlogin.net/shares</code> to access the USB device within your network and download or upload files. In this URL, readyshare is the name that is specified in the Network/Device Name field. If you change the name in the Network/Device Name field from readyshare to another name, the link changes accordingly. You can also click the link that is shown in the Link column. The fixed port is number is 21.
FTP (via internet)	Disabled by default. If you enable this feature, remote users can type <code>ftp://<public IP address>/shares</code> to access the USB device over the Internet and download or upload files. <i><public IP address></i> is the external or public IP address that is assigned to the modem router (for example, 1.1.10.102). The default port is number 21, which you can change. If you set up Dynamic DNS (see Set Up and Manage Dynamic DNS on page 158), you can also type a URL domain name. For example, if your domain name is MyName and you use the NETGEAR DDNS server, you can type <code>ftp://MyName.mynetgear.com</code> to access the USB device over the Internet and download or upload files.

- Click the **Apply** button.
Your settings are saved.

Enable FTP Access Within Your Network

File Transfer Protocol (FTP) lets you download (receive) and upload (send) large files faster.

Note For information about using FTP to access a storage device over the Internet, see [Manage Dynamic DNS and Access Storage Devices Through the Internet](#) on page 157.

Share a Storage Device

► **To enable FTP access within your network:**

1. Launch a web browser from a WiFi-enabled computer or mobile device that is connected to the network.
2. Enter **http://www.routerlogin.net**.
A login window opens.
3. Enter the modem router user name and password.
The user name is **admin**. The default password is **password**. The user name and password are case-sensitive.
The BASIC Home page displays.
4. Select **ADVANCED > ReadySHARE > Advanced Settings**.

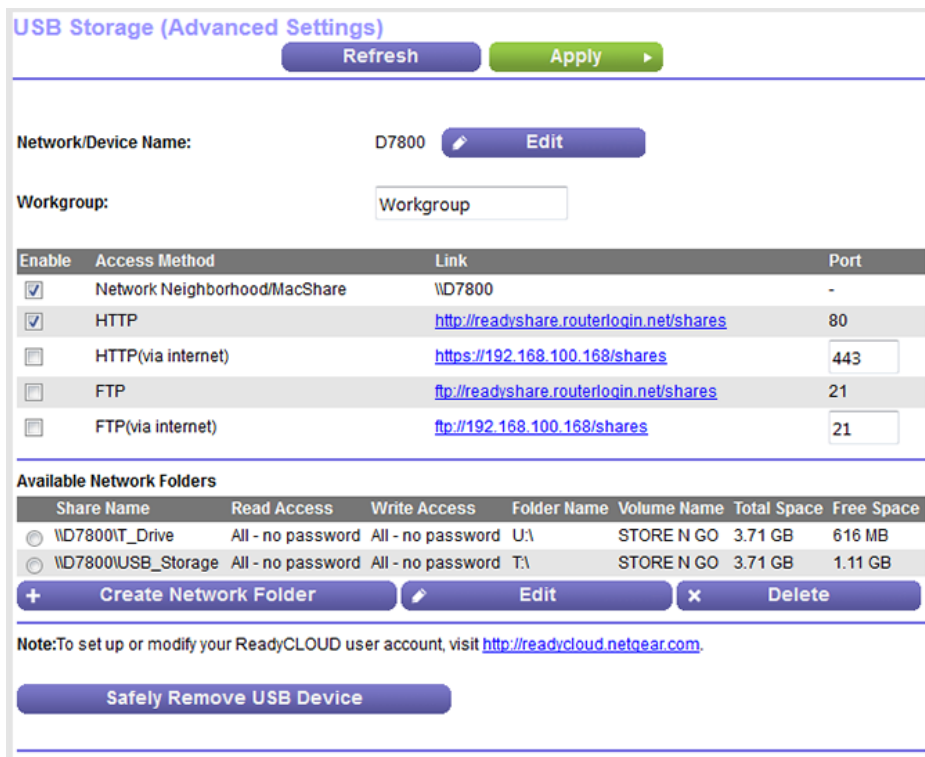

The previous figure shows two USB devices attached to the modem router.

5. Select the **FTP** check box.
6. Click the **Apply** button.
Your settings are saved.

View Network Folders on a Device

You can view the network folders on a USB storage device connected to the modem router.

► **To view network folders:**

1. Launch a web browser from a WiFi-enabled computer or mobile device that is connected to the network.
2. Enter **http://www.routerlogin.net**.
A login window opens.
3. Enter the modem router user name and password.
The user name is **admin**. The default password is **password**. The user name and password are case-sensitive.
The BASIC Home page displays.
4. Select **ADVANCED > ReadySHARE > Advanced Settings**.

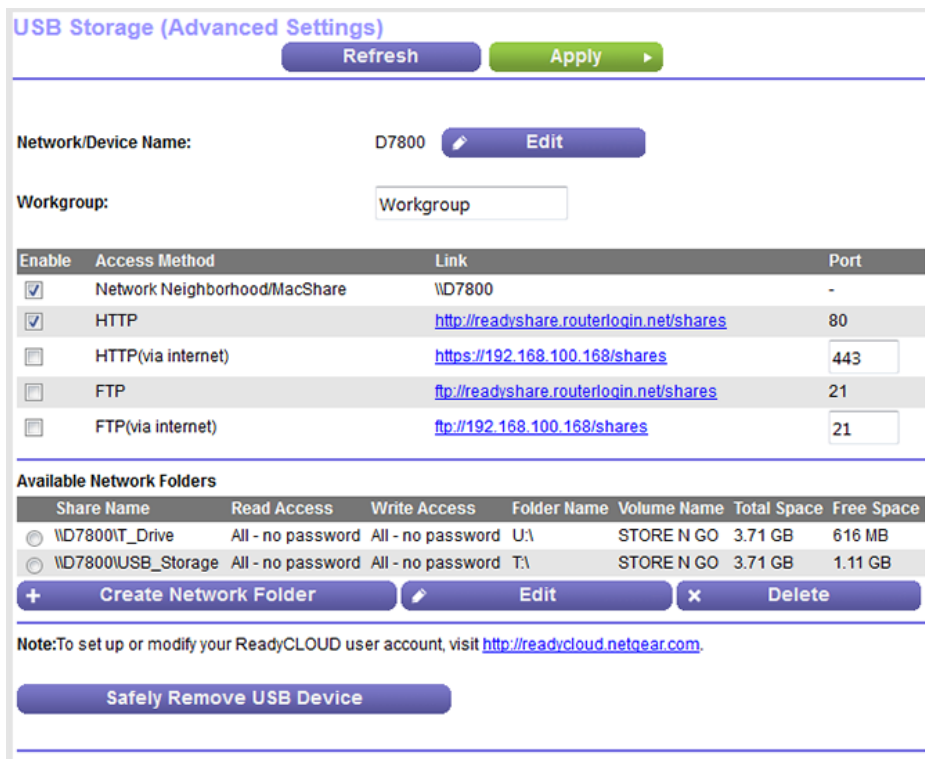

The previous figure shows two USB devices attached to the modem router.

5. The Available Networks Folder section shows the following settings:
 - **Share Name.** The default share name is USB_Storage.
 - **Read Access and Write Access.** The permissions and access controls on the network folder. All-no password (the default) allows all users to access the network folder. The password for admin is the same one that you use to log in to the modem router.
 - **Folder Name.** Full path of the network folder.
 - **Volume Name.** Volume name from the storage device.
 - **Total Space and Free Space.** The current utilization of the storage device.

Add a Network Folder on a Storage Device

You can add network folders on a storage device connected to the USB port on the modem router.

► **To add a network folder to a storage device:**

1. Launch a web browser from a WiFi-enabled computer or mobile device that is connected to the network.
2. Enter **http://www.routerlogin.net**.
A login window opens.
3. Enter the modem router user name and password.
The user name is **admin**. The default password is **password**. The user name and password are case-sensitive.
The BASIC Home page displays.
4. Select **ADVANCED > ReadySHARE > Advanced Settings**.

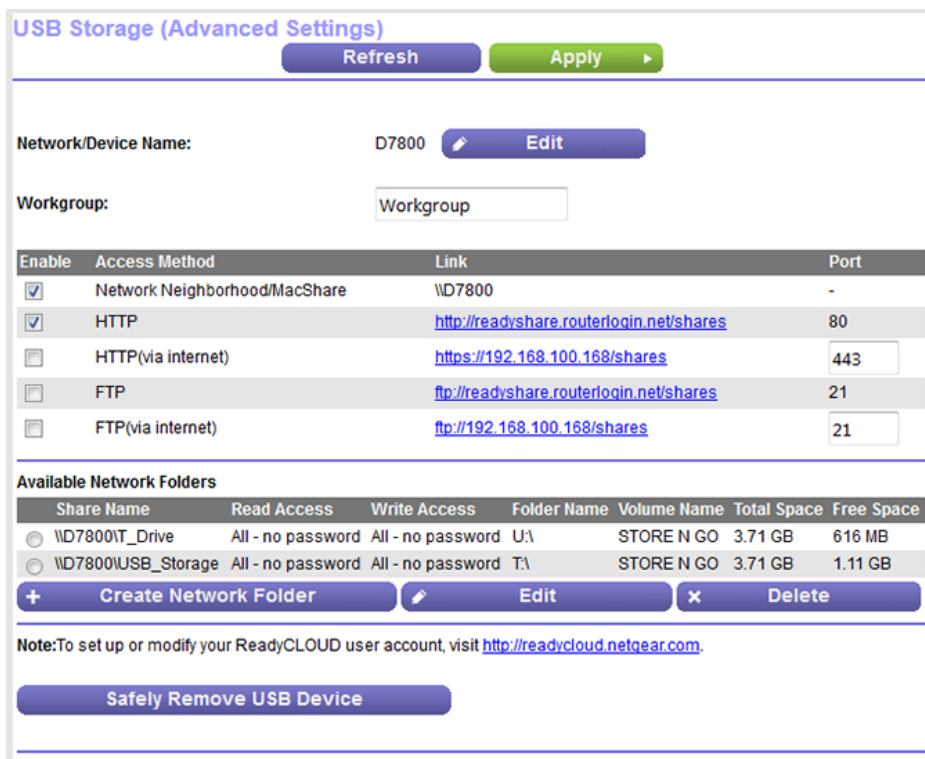

The previous figure shows two USB devices attached to the modem router.

5. In the Available Network Folders table, select the device.

- Click the **Create Network Folder** button.

Create Network Folder

USB Device	U:(STORE N GO) ▾
Folder	<input type="text"/> Browse
Share Name	<input type="text"/>
Read Access	All - no password ▾
Write Access	All - no password ▾

Apply ▶

✕ **Close Window**

If this pop-up window does not display, your web browser might be blocking pop-ups. If it is, change the browser settings to allow pop-ups.

- From the **USB Device** menu, select the USB drive.

Note We recommend that you do not attach more than one drive to each USB port (for example, through a USB hub).

- Click the **Browse** button.
Another pop-up window opens.
- Navigate to the folder in which you want to create a new share and select the folder.
- Click the **OK** button.
The pop-up window closes. The folder displays in the **Folder** field in the Create Network Folder pop-up window.
- In the **Share Name** field, type the name of the share.
- From the **Read Access** menu and the **Write Access** menu, select the settings that you want.
All-no password (the default) allows all users to access the network folder. The other option is that only the admin user is allowed access to the network folder. The password for admin is the same one that you use to log in to the modem router.
- Click the **Apply** button.
The folder is added on the storage device.
- Click the **Close Window** button.
The pop-up window closes.

Change a Network Folder, Including Read and Write Access, on a USB Drive

You can change network folders on storage devices connected to the USB port on the modem router.

► **To change a network folder on a storage device:**

1. Launch a web browser from a WiFi-enabled computer or mobile device that is connected to the network.
2. Enter **http://www.routerlogin.net**.
A login window opens.
3. Enter the modem router user name and password.
The user name is **admin**. The default password is **password**. The user name and password are case-sensitive.
The BASIC Home page displays.
4. Select **ADVANCED > ReadySHARE > Advanced Settings**.

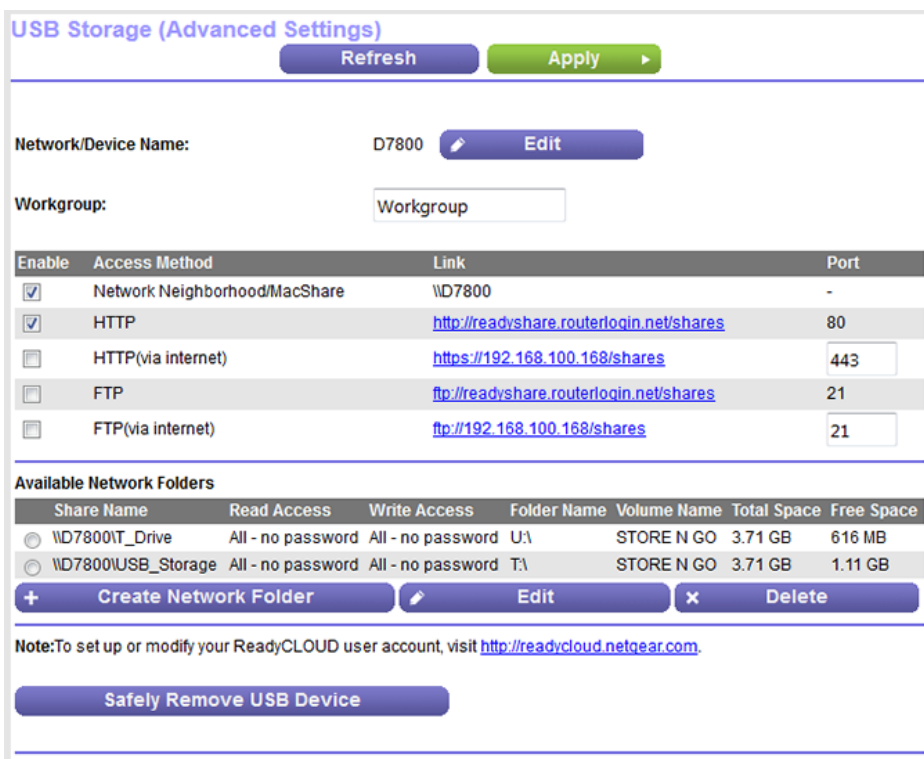

The previous figure shows two USB devices attached to the modem router.

5. In the Available Network Folders table, select the device.

- Click the **Edit** button.

Edit Network Folder

USB Device	U:(STORE N GO)
File System	FAT32
Folder	U:\ <input type="button" value="Browse"/>
Share Name	T_Drive
Read Access	All - no password ▾
Write Access	All - no password ▾

- Change the settings in the fields as needed.
For more information about the settings, see [Add a Network Folder on a Storage Device](#) on page 151.
- Click the **Apply** button.
Your settings are saved.
- Click the **Close Window** button.
The pop-up window closes.

Approve Storage Devices

For more security, you can set up the modem router to share only storage devices that you approve.

▶ To allow only approved storage devices to connect to the modem router and specify which storage devices are approved:

- Make sure that the storage device or devices that you want to approve are attached to the modem router.
- Launch a web browser from a WiFi-enabled computer or mobile device that is connected to the network.
- Enter **http://www.routerlogin.net**.
A login window opens.
- Enter the modem router user name and password.
The user name is **admin**. The default password is **password**. The user name and password are case-sensitive.
The BASIC Home page displays.

5. Select **ADVANCED > Advanced Setup > USB Settings**.

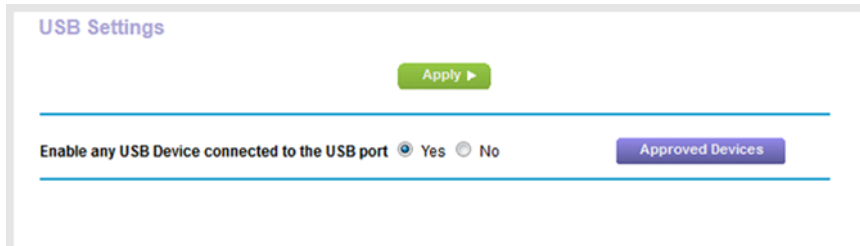

6. Select the **No** radio button.
By default the **Yes** radio button is selected. This setting lets you connect and access all your storage devices.
7. Click the **Apply** button.
Your settings are saved.
8. Click the **Approved Devices** button.

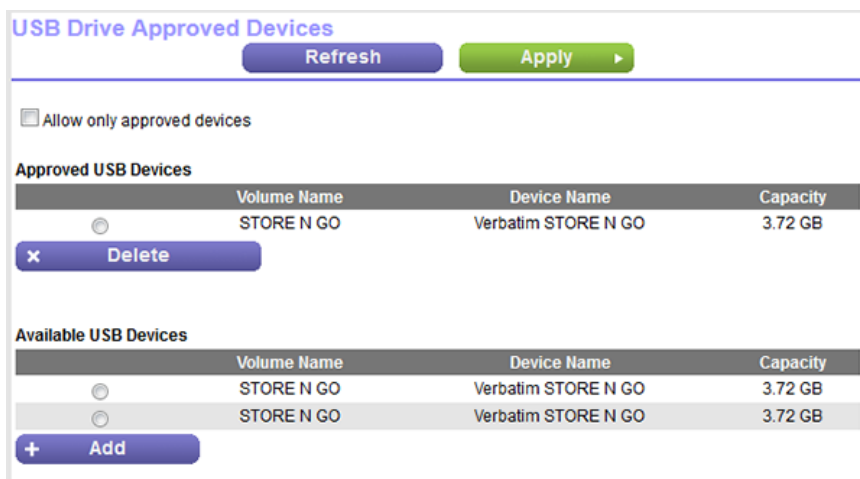

9. In the Available USB Devices table, select the storage device that you want to approve.
10. Click the **Add** button.
The storage device is added to the Approved USB Devices table.
11. To approve a second storage device that is attached to the modem router, repeat Step 9 and Step 10.
12. Select the **Allow only approved devices** check box.
13. Click the **Apply** button.
Your settings are saved.

To approve another USB device that is not connected to a USB port, first remove a USB device from the USB port (see [Safely Remove a USB Device](#) on page 156), connect the other USB device, and repeat this procedure.

Safely Remove a USB Device

Before you physically disconnect a USB device from the USB port on the modem router, log in to the modem router, and take the drive offline.

► **To remove a USB device safely:**

1. Launch a web browser from a WiFi-enabled computer or mobile device that is connected to the network.
2. Enter **http://www.routerlogin.net**.
A login window opens.
3. Enter the modem router user name and password.
The user name is **admin**. The default password is **password**. The user name and password are case-sensitive.
The BASIC Home page displays.
4. Select **ADVANCED > ReadySHARE > Advanced Settings**.

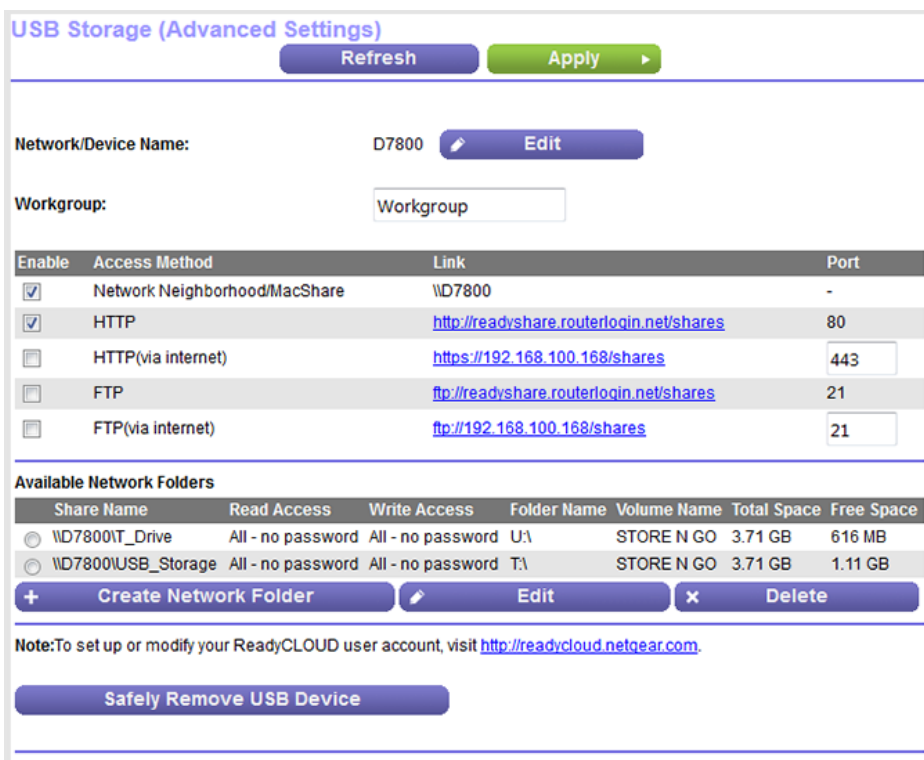

The previous figure shows two USB devices attached to the modem router.

5. In the Available Network Folders table, select the device.
6. Click the **Safely Remove USB Device** button.
The device goes offline and a pop-up window opens.
7. Click the **OK** button.
8. Physically disconnect the USB device.

Manage Dynamic DNS and Access Storage Devices Through the Internet

8

With Dynamic DNS, you can use the Internet and a personal domain name to access a USB storage device that is attached to a USB port on the modem router when you are not home. If you know the IP address of the modem router (and the IP address did not change), you can also access the USB storage device by using the IP address.

This chapter includes the following sections:

- *Set Up and Manage Dynamic DNS* on page 158
- *Access Storage Devices Through the Internet* on page 162

Note For information about how to connect the device and specify its settings, see *Share a Storage Device* on page 140.

Set Up and Manage Dynamic DNS

Internet service providers (ISPs) assign numbers called IP addresses to identify each Internet account. Most ISPs use dynamically assigned IP addresses. This means that the IP address can change at any time. You can use the IP address to access your network remotely, but most people do not know what their IP address is or when this address changes.

To make it easier to connect, you can get a free account with a Dynamic DNS service that lets you use a domain name to access your home network. To use this account, you must set up the modem router to use Dynamic DNS. Then the modem router notifies the Dynamic DNS service provider whenever its IP address changes. When you access your Dynamic DNS account, the service finds the current IP address of your home network and automatically connects you.

If your ISP assigns a private WAN IP address (such as 192.168.x.x or 10.x.x.x), the Dynamic DNS service does not work because private addresses are not routed on the Internet.

Your Personal FTP Server

With your customized free URL, you can use FTP to access your network when you are not home through Dynamic DNS. To set up your FTP server, you must register for a NETGEAR Dynamic DNS (DDNS) service account and specify the account settings.

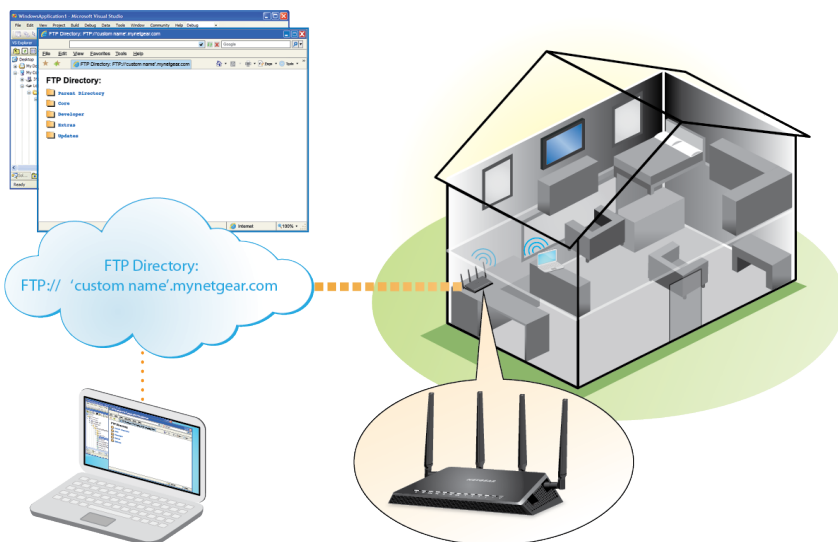

Figure 12. You can access your network through the Internet when you're not home

Note The modem router supports only basic DDNS, and the login and password might not be secure. You can use DDNS with a VPN tunnel for a secure connection.

► To set up your personal account and use FTP:

1. Get your NETGEAR Dynamic DNS domain name.
For more information, see [Set Up a New Dynamic DNS Account](#) on page 159.
2. Make sure that your Internet connection is working.
Your modem router must use a direct Internet connection. It cannot connect to a different router to access the Internet.
3. Connect a storage device the modem router.
You can connect an eSATA device to the eSATA port and you can connect USB storage devices to the USB ports on the modem router.
4. If your USB device uses a power supply, connect it.
You must use the power supply when you connect the USB device to the modem router.

When you connect the storage device to the modem router's port, it might take up to two minutes before the storage device is ready for sharing. By default, the device is available to all computers on your local area network (LAN).
5. Set up FTP access on the modem router.
For more information, see [Set Up FTP Access Through the Internet](#) on page 162.
6. On a remote computer with Internet access, you can use FTP to access your modem router using `ftp://yourname.mynetwork.com`, in which *yourname* is your specific domain name.
For more information, see [Use FTP to Access Storage Devices Through the Internet](#) on page 164.

Set Up a New Dynamic DNS Account

NETGEAR offers you the opportunity to set up and register for a free Dynamic DNS account.

► To set up Dynamic DNS and register for a free NETGEAR account:

1. Launch a web browser from a computer or mobile device that is connected to the network.
2. Enter <http://www.routerlogin.net>.
A login window opens.
3. Enter the modem router user name and password.
The user name is **admin**. The default password is **password**. The user name and password are case-sensitive.

The BASIC Home page displays.

4. Select **ADVANCED > Advanced Setup > Dynamic DNS**.

5. Select the **Use a Dynamic DNS Service** check box.
6. From the **Service Provider** menu, select **NETGEAR**.
7. Select the **No** radio button.
8. In the **Host Name** field, enter the name that you want to use for your URL.
The host name is sometimes called the domain name. Your free URL includes the host name that you specify and ends with mynetgear.com. For example, enter *MyName.mynetgear.com*.
9. In the **Email** field, enter the email address that you want to use for your account.
10. In the **Password (6-32 characters)** field, enter the password that you want to use for your account.
11. Click the **Register** button.
12. Follow the onscreen instructions to register for your NETGEAR Dynamic DNS service.

Specify a DNS Account That You Already Created

If you already created a Dynamic DNS account with NETGEAR, No-IP, or Dyn, you can set up the modem router to use your account.

► To set up Dynamic DNS if you already created an account:

1. Launch a web browser from a computer or mobile device that is connected to the network.
2. Enter **http://www.routerlogin.net**.
A login window opens.
3. Enter the modem router user name and password.
The user name is **admin**. The default password is **password**. The user name and password are case-sensitive.
The BASIC Home page displays.

4. Select **ADVANCED > Advanced Settings > Dynamic DNS**.

The screenshot shows the 'Dynamic DNS' configuration page. At the top, there are buttons for 'Show Status', 'Cancel', and 'Apply', along with a 'powered by no-ip' logo. The main section is titled 'Dynamic DNS' and contains a checkbox labeled 'Use a Dynamic DNS Service' which is currently unchecked. Below this, there is a 'Service Provider' dropdown menu set to 'NETGEAR'. A question asks 'Do you have a NETGEAR DDNS or a No-IP DDNS account?' with 'Yes' and 'No' radio buttons; 'No' is selected. The registration section prompts for 'Host Name', 'Email', and 'Password (6-32 characters)'. The 'Host Name' field has a placeholder ending in '.mynetgear.com'. A 'Register' button is visible at the bottom of the form, and a note states: 'By submitting this form I agree to the [terms of service](#) and that I will only create one free account.'

5. Select the **Use a Dynamic DNS Service** check box.
6. From the **Service Provider** menu, select your provider.
7. Select the **Yes** radio button.

This screenshot is identical to the previous one, but the 'Use a Dynamic DNS Service' checkbox is now checked. Additionally, the 'Yes' radio button is selected for the account type question. The 'Host Name', 'Email', and 'Password' fields are still empty. The 'Register' button is no longer visible, and the bottom note has been replaced with: 'Forget your password? [click here](#)
To manage your DDNS account, [click here](#)'.

8. In the **Host Name** field, enter the host name (sometimes called the domain name) for your account.
9. Depending on the type of account, specify your user name or email address:
 - For a No-IP or Dyn account, in the **User Name** field, enter the user name for your account.
 - For a NETGEAR account, in the **Email** field, enter the email address for your account.
10. In the **Password (6-32 characters)** field, enter the password for your DDNS account.
11. Click the **Apply** button.
Your settings are saved.
12. To verify that your Dynamic DNS service is enabled in the modem router, click the **Show Status** button.
A message displays the Dynamic DNS status.

Change the Dynamic DNS Settings

You can change the settings for your Dynamic DNS account.

► To change your settings:

1. Launch a web browser from a computer or WiFi device that is connected to the network.
2. Enter **http://www.routerlogin.net**.
A login window opens.
3. Enter the modem router user name and password.
The user name is **admin**. The default password is **password**. The user name and password are case-sensitive.
The BASIC Home page displays.
4. Select **ADVANCED > Advanced Setup > Dynamic DNS**.
The Dynamic DNS page displays.
5. Change your DDNS account settings as necessary.
6. Click the **Apply** button.
Your settings are saved.

Access Storage Devices Through the Internet

If you connect a USB storage device to the modem router, you can access the USB device through the Internet when you are not home. After you gain access, you can use FTP to share files on the USB device.

Access Storage Devices From a Remote Computer

From a remote computer, you can access storage devices that are attached to the modem router on your home network.

► To access devices from a remote computer:

1. Launch a web browser on a computer that is not on your home network.
2. Connect to the modem router on your home network:
 - To connect with Dynamic DNS, type the DNS name.
To use a Dynamic DNS account, you must enter the account information on the Dynamic DNS page (see *Set Up and Manage Dynamic DNS* on page 158).
 - To connect without Dynamic DNS, type the modem router's Internet port IP address.
You can view the modem router's Internet IP address on the BASIC Home page.

Set Up FTP Access Through the Internet

If you attach a storage device to the modem router, you can access the storage device from your network (see *Enable FTP Access Within Your Network* on page 148). You can also set up FTP access through the

Nighthawk X4S AC2600 WiFi VDSL/ADSL Modem Router Model D7800

Internet so that you can access the storage device from outside your local network, for example, when you are not at home.

► To set up FTP access through the Internet:

1. Launch a web browser from a computer or WiFi device that is connected to the network.
2. Enter **http://www.routerlogin.net**.
The login window opens.
3. Enter the modem router user name and password.
The user name is **admin**. The default password is **password**. The user name and password are case-sensitive.
The BASIC Home page displays.
4. Select **ADVANCED > ReadySHARE > Advanced Settings**.

USB Storage (Advanced Settings)

Refresh Apply

Network/Device Name: D7800 Edit

Workgroup: Workgroup

Enable	Access Method	Link	Port
<input checked="" type="checkbox"/>	Network Neighborhood/MacShare	\\D7800	-
<input checked="" type="checkbox"/>	HTTP	http://readyshare.routerlogin.net/shares	80
<input type="checkbox"/>	HTTP(via internet)	https://192.168.100.168/shares	443
<input type="checkbox"/>	FTP	ftp://readyshare.routerlogin.net/shares	21
<input type="checkbox"/>	FTP(via internet)	ftp://192.168.100.168/shares	21

Available Network Folders

Share Name	Read Access	Write Access	Folder Name	Volume Name	Total Space	Free Space
<input type="radio"/> \\D7800\IT_Drive	All - no password	All - no password	U:\	STORE N GO	3.71 GB	616 MB
<input type="radio"/> \\D7800\USB_Storage	All - no password	All - no password	T:\	STORE N GO	3.71 GB	1.11 GB

+ Create Network Folder Edit X Delete

Note: To set up or modify your ReadyCLOUD user account, visit <http://readycloud.netgear.com>.

Safely Remove USB Device

The previous figure shows two USB devices attached to the modem router.

5. Select the **FTP (via internet)** check box.
6. Click the **Apply** button.
Your settings are saved.
7. To limit access to the admin user, do the following:

Nighthawk X4S AC2600 WiFi VDSL/ADSL Modem Router Model D7800

- a. In the Available Network Folders list, select a device.
If only one device is connected, it is automatically selected.
- b. Click the **Edit** button.

Edit Network Folder

USB Device	U:(STORE N GO)
File System	FAT32
Folder	U:\ <input type="button" value="Browse"/>
Share Name	T_Drive
Read Access	All - no password ▾
Write Access	All - no password ▾

- c. In the **Read Access** menu, select **admin**.
The default setting is **All - no password**.
- d. In the **Write Access** menu, select **admin**.
The default setting is **All - no password**.
- e. Click the **Apply** button.
Your settings are saved.
- f. Click the **Close Window** button.
The pop-up window closes.

Use FTP to Access Storage Devices Through the Internet

If you attached a storage device to the modem router, before you can access the storage device through the Internet with FTP, you must first set up FTP access (see [Set Up FTP Access Through the Internet](#) on page 162).

► To access a USB device with FTP from a remote computer to download or upload a file:

1. Take one of the following actions:
 - To download a file from a storage device connected to the modem router, launch a web browser.
 - To upload a file to a storage device connected to the modem router, launch an FTP client such as Filezilla.
2. Type **ftp://** and the Internet port IP address in the address field of the browser.
For example, if your IP address is 10.1.65.4, type **ftp://10.1.65.4**.

If you are using Dynamic DNS, type the DNS name. For example, type **ftp://MyName.mynetgear.com**, in which *MyName* is your DNS name.
3. When prompted, log in:

Nighthawk X4S AC2600 WiFi VDSL/ADSL Modem Router Model D7800

- To log in as admin, in the **user name** field, enter **admin** and in the **password** field, enter the same password that you use to log in to the modem router.
- To log in as a guest, in the **user name** field, enter **guest**.
The guest user name does not need a password.

The files and folders that your account can access on the USB device display. For example, you might see `share/partition1/directory1`.

4. Navigate to a location on the USB device.
5. Download or upload the file.

Use the Modem Router as a Media Server 9

The modem router comes set up to work as a ReadyDLNA media server. You can set up the modem router to play music from iTunes Server and media from TiVo.

This chapter contains the following sections:

- *Specify ReadyDLNA Media Server Settings* on page 167
- *Rescan the Media Files for Content* on page 167
- *Play Music From a Storage Device With iTunes Server* on page 168
- *Play Media From a USB Device on TiVo* on page 169

Specify ReadyDLNA Media Server Settings

By default, the modem router functions as a ReadyDLNA media server, which lets you view movies and photos on DLNA/UPnP AV-compliant media players, such as Xbox360, Playstation, and NETGEAR media players.

► To specify media server settings:

1. Launch a web browser from a computer or WiFi device that is connected to the network.
2. Enter **http://www.routerlogin.net**.
A login window opens.
3. Enter the modem router user name and password.
The user name is **admin**. The default password is **password**. The user name and password are case-sensitive.
The BASIC Home page displays.
4. Select **ADVANCED > ReadySHARE > Media Server**.
The Media Server (Settings) page displays.
5. Specify the settings:
 - **Enable Media Server**. Select this check box to enable this device to function as a media server.
 - **Enable TiVo support**. Select this check box if you want to play USB or ReadyNAS media on your TiVo device. See *Play Media From a USB Device on TiVo* on page 169.
6. Click the **Apply** button.
Your settings are saved.
7. To change the name of the media server, click the **Edit** button.
The LAN Setup page displays.
8. In the **Device Name** field, type a new device name for the modem router.
By default, the device name is D7800.
9. Click the **Apply** button.
Your settings are saved.

Rescan the Media Files for Content

When new media files are added, the modem router scans for content automatically. You can also rescan the media files for content.

► To rescan the media files for content:

1. Launch a web browser from a computer or WiFi device that is connected to the network.
2. Enter **http://www.routerlogin.net**.
A login window opens.

3. Enter the modem router user name and password.
The user name is **admin**. The default password is **password**. The user name and password are case-sensitive.
The BASIC Home page displays.
4. Select **ADVANCED > ReadySHARE > Media Server**.
The Media Server (Settings) page displays.
5. Click the **Rescan media files** button.
The modem router rescans for content.

Play Music From a Storage Device With iTunes Server

iTunes Server lets you play music with your Windows or Mac iTunes app from a storage device that is connected to the modem router. You can also use the Apple Remote app from an iPhone or iPad to play music on any AirPlay devices, such as Apple TV or AirPlay-supported receivers.



Figure 13. Play music on a USB device with iTunes

Supported music file formats are MP3, AAC, and FLAC. The maximum number of music files supported is 10,000.

► To specify iTunes server settings:

1. On your iPhone or iPad, find and connect to the WiFi network.
2. Launch the Remote app.
3. Tap the **Add a Device** button.
A passcode displays.
4. Specify the passcode in the modem router:

Nighthawk X4S AC2600 WiFi VDSL/ADSL Modem Router Model D7800

- a. Launch a web browser from a computer or WiFi device that is connected to the network.
- b. Enter **http://www.routerlogin.net**.
A login window opens.
- c. Enter the modem router user name and password.
The user name is **admin**. The default password is **password**. The user name and password are case-sensitive.
The BASIC Home page displays.
- d. Select **ADVANCED > ReadySHARE > Media Server**.

The screenshot shows the 'Media Server (Settings)' page. It has a title bar 'Media Server (Settings)'. Below it are three checked checkboxes: 'Enable Media Server', 'Enable TiVo® support.', and 'Enable iTunes Server (Music Only)'. The third checkbox is currently unchecked. Below these is a text input field labeled 'Enter Passcode displayed on the Remote App' with a small white box next to it. To the right of this field is a blue button labeled 'Allow Control'. Below the passcode field is the text 'Media Server Name : D7800' with a blue button labeled 'Edit' to its right. At the bottom of this section is a green button labeled 'Apply' with a right-pointing arrow. Below this is a section titled 'Content Scan' with a radio button selected for 'Automatic (when new files added)'. At the bottom of the page is a large green button labeled 'Rescan media files' with a right-pointing arrow.

- e. Select the **Enable iTunes Media Server (Music Only)** check box.
- f. If the **Enter Passcode displayed on the Remote App** field is masked, click the **Apply** button.
- g. Enter the passcode.
- h. Click the **Allow Control** button.
- i. Click the **Apply** button.
Your settings are saved.

On your iPhone or iPad, the ReadySHARE music library displays in the remote app. You can play this music on AirPlay devices.

Play Media From a USB Device on TiVo

You can set up your TiVo to access media files stored on a USB device that is connected to your modem router. The TiVo must be on the same network as the modem router. This feature supports the following file formats:

- **Video.** See and play MPEG1, and MPEG2 files.
- **Music.** See and play MP3 files.
- **Pictures.** View images in .JPG format.

You can use the TiVo (Series 2 and up) Home Media Option to play photos and music on your Windows or Mac computer in your TiVo user interface.

Set Up the Modem Router to Work With TiVo

▶ To set up the modem router to work with TiVo:

1. Launch a web browser from a computer or WiFi device that is connected to the network.
2. Enter **http://www.routerlogin.net**.
A login window opens.
3. Enter the modem router user name and password.
The user name is **admin**. The default password is **password**. The user name and password are case-sensitive.
The BASIC Home page displays.
4. Select **ADVANCED > ReadySHARE > Media Server**.
The Media Server (Settings) page displays.
5. Make sure that the **Enable TiVo support** check box is selected.
6. If you changed the setting, click the **Apply** button.
Your settings are saved.

Play Videos

▶ To play videos:

1. On the TiVo, select **TiVo Central > My Shows**.
2. Go to the bottom of the list and select the D7800.

Play Music or View Photos

▶ To play music or view photos:

1. On the TiVo, select **TiVo Central > Music, Photos, & Showcases**.
2. Select an item to play or watch.

Copy TiVo Files to a Computer

▶ To copy TiVo files to a computer:

Use the TiVo Desktop accessory, available at <https://www3.tivo.com/store/accessories-software.do>.

The ReadySHARE Printer utility lets you share a USB printer that is connected to the USB port on your modem router. You can share this USB printer among the Windows and Mac computers on your network.

This chapter contains the following sections:

- *Install the Printer Driver and Cable the Printer* on page 172
- *Download the ReadySHARE Printer Utility* on page 172
- *Install the ReadySHARE Printer Utility* on page 172
- *Use the Shared Printer* on page 174
- *View or Change the Status of a Printer* on page 175
- *Use the Scan Feature of a Multifunction USB Printer* on page 176
- *Manage the NETGEAR USB Control Center Settings* on page 177

Install the Printer Driver and Cable the Printer

Some USB printer manufacturers (for example, HP and Lexmark) request that you do not connect the USB cable until the installation software prompts you to do so.

► To install the driver and cable the printer:

1. On each computer on your network that shares the USB printer, install the driver software for the USB printer.
If the printer driver is not installed, contact the printer manufacturer.
2. Use a USB printer cable to connect the USB printer to a modem router USB port on the left side panel.



Download the ReadySHARE Printer Utility

The utility works on Windows-based computers, Mac computers, smartphones, and tablets.

► To download the ReadySHARE Printer utility:

1. Visit netgear.com/readyshare.
2. Scroll down to the Print From the Comfort of Your Home Network section at the bottom of the page.
3. Click one of the following links:
 - **Download PC installer and get started.** This is the utility for Windows-based computers.
 - **Download Mac installer and get started.** This is the utility for MAC computers.
 - **Download the genie App and get started.** This is the utility for smartphones and tablets.
4. Follow the onscreen instructions to download the ReadySHARE Printer utility setup file.

Install the ReadySHARE Printer Utility

You must install the ReadySHARE Printer utility on each computer that will share the printer. After you install it, the utility displays as NETGEAR USB Control Center on your computer.

► To install the utility:

1. If necessary, unzip the ReadySHARE Printer utility setup file.
2. Double-click the ReadySHARE Printer utility setup file that you downloaded.



3. Follow the wizard instructions to install NETGEAR USB Control Center. After the InstallShield Wizard completes the installation, the NETGEAR USB Control Center prompts you to select a language.



4. Select a language from the menu and click the **OK** button.

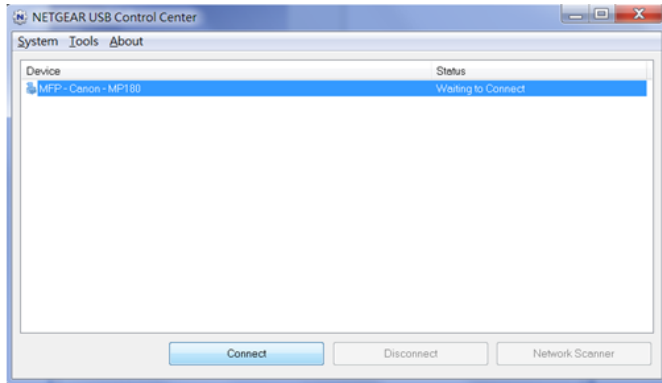

Some firewall software, such as Comodo, blocks NETGEAR USB Control Center from accessing the USB printer. If you do not see the USB printer displayed onscreen, you can disable the firewall temporarily to allow the utility to work.

5. Select the printer and click the **Connect** button.
The printer status changes to Manually connected by *Mycomputer*. Now only the computer that you are using can use this printer.
6. Click the **Disconnect** button.
The status changes to Available. Now all computers on the network can use the printer.
7. To exit the utility, select **System > Exit**.

Use the Shared Printer

For each computer, after you click the **Connect** and **Disconnect** buttons once, the utility automatically manages the printing queue. By default, the utility starts automatically whenever you log on to Windows and runs in the background.

Manually Connect and Print

For each computer, after you click the **Connect** and **Disconnect** buttons once, the utility automatically manages the printing queue. By default, the utility starts automatically whenever you log on to Windows and runs in the background.

► To manually connect and print:

1. Click the **NETGEAR USB Control Center** icon .
The main page displays.
2. Click the **Connect** button.
The printer status changes to Manually connected by *Mycomputer*. Now only the computer that you are using can use this printer.
3. Use the print feature in your application to print your document.
4. To release the printer so that all computers on the network can use it, click the **Disconnect** button.

Print and Release the Printer

► To print and release the printer to any computer on the network:

1. To print your document, use the print feature in your application.
The NETGEAR USB Control Center automatically connects your computer to the USB printer and prints the document. If another computer is already connected to the printer, your print job goes into a queue to wait to be printed.
2. If your document does not print, use the NETGEAR USB Control Center to check the status.
See *View or Change the Status of a Printer* on page 175.

View or Change the Status of a Printer

► To view or change the status:

1. Click the **NETGEAR USB Control Center** icon .

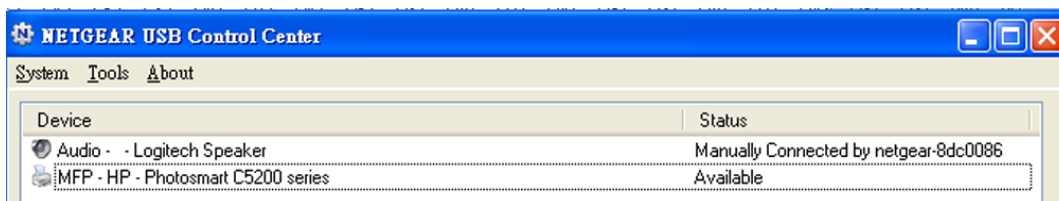

The Status column shows the status for each device:

- **Available.** No print jobs are in progress. You can use the USB printer from any computer in the network.
 - **Connected.** Your computer is connected to the printer and will be released when your print job is done.
 - **Manually Connected by.** Only the connected computer can use the printer.
 - **Waiting to Connect.** Your computer is not connected to the shared printer yet.
2. To print from your computer when the status shows Manually connected by *another computer*, click the **Disconnect** button.
The printer is released from the connection and the status changes to Available.
 3. To print from your computer when the status shows Waiting to Connect, do the following:
 - a. Click the **Connect** button.
The printer status changes to Manually connected by *Mycomputer*. Now only your computer can use the printer.
 - b. To allow the printer to be shared, click the **Disconnect** button.
The printer is released from the connection and the status changes to Available.

Use the Scan Feature of a Multifunction USB Printer

If your USB printer supports scanning, you can also use the USB printer for scanning. For example, the USB printer displayed in the Windows Printers and Faxes window is ready for print jobs.

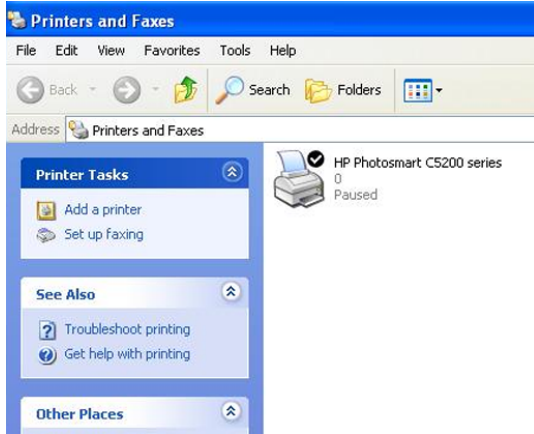
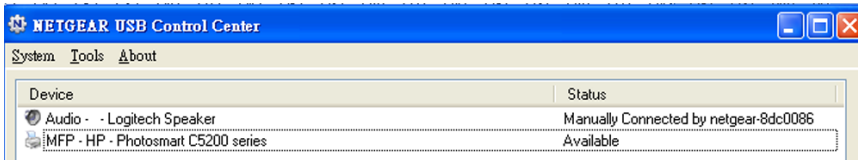

Figure 14. Printers and Faxes window

► To use the scan feature of a multifunction USB printer:

1. Click the **NETGEAR USB Control Center** icon .



2. Make sure that the printer status shows as Available.
3. Click the **Network Scanner** button.

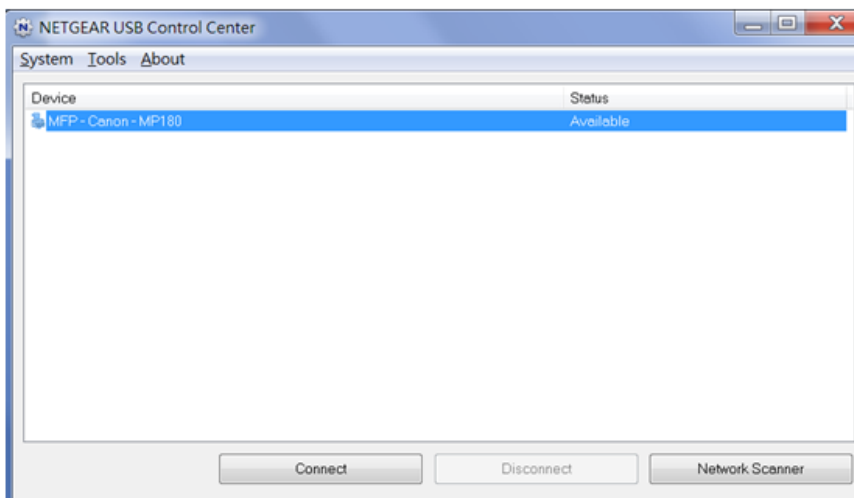

The scanner page displays so that you can use the USB printer for scanning.

Manage the NETGEAR USB Control Center Settings

You can stop the NETGEAR USB Control Center from starting automatically when you log in to Windows. You can also change the language and specify the time-out to release the printer connection.

Turn Off Automatic Startup of the NETGEAR USB Control Center

You can stop the NETGEAR USB Control Center from starting automatically when you log in to Windows.

► **To turn off the automatic startup of the NETGEAR USB Control Center:**

1. Click the **NETGEAR USB Control Center** icon .

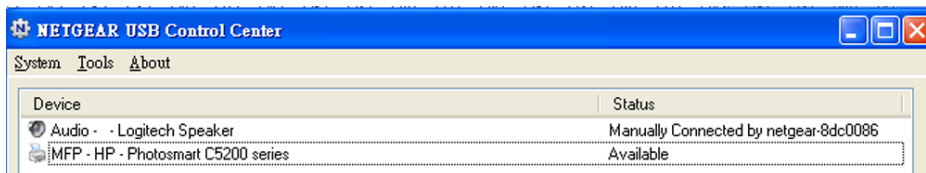

2. Select **Tools > Configuration**.

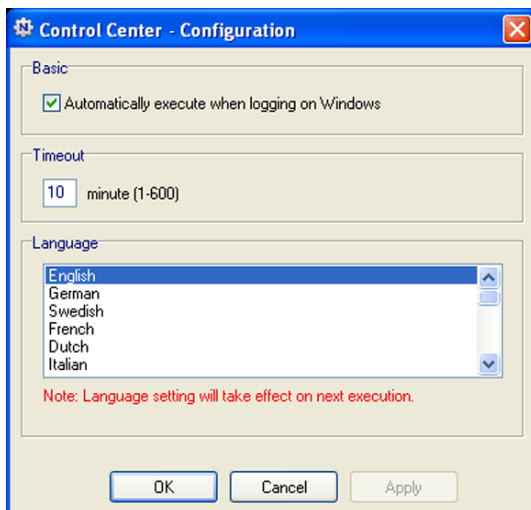

3. Clear the **Automatically execute when logging on Windows** check box.
4. Click the **OK** button.
Your settings are saved.

Change the NETGEAR USB Control Center Language

► To change the language:

1. Click the **NETGEAR USB Control Center** icon .
The main page displays.
2. Select **Tools > Configuration**.
The Control Center - Configuration page displays.
3. From the **Language** menu, select a language.
4. Click the **OK** button.
The next time the NETGEAR USB Control Center starts, the language changes.

Specify the USB Control Center Time-Out

► To specify the time-out:

1. Click the **NETGEAR USB Control Center** icon .
The main page displays.
2. Select **Tools > Configuration**.
The Control Center - Configuration page displays.
3. In the **Timeout** field, type the number of minutes.
The time-out is the number of minutes that a computer holds its connection to the printer when the connection is not being used.
4. Click the **OK** button.
Your settings are saved and the Control Center - Configuration page displays.

Manage the WAN and LAN Network Settings

11

This chapter describes how you can manage the WAN and LAN network settings of the modem router.

The chapter includes the following sections:

- *Change the Physical WAN Connection Preference* on page 180
- *Enable Bridge Mode for IPTV Devices* on page 180
- *Enable and Configure a VLAN* on page 182
- *Set Up a Bridge for a Port Group or VLAN Tag Group* on page 184
- *Manage the WAN Security Settings* on page 187
- *Set Up a Default DMZ Server* on page 188
- *Manage IGMP Proxying* on page 189
- *Manage NAT Filtering* on page 189
- *Manage the SIP Application-Level Gateway* on page 190
- *Manage the Modem Routers's LAN IP Address Settings* on page 191
- *Manage the Router Information Protocol Settings* on page 192
- *Manage the DHCP Server Address Pool* on page 193
- *Manage Reserved LAN IP Addresses* on page 194
- *Disable the Built-In DHCP Server* on page 196
- *Change the Modem Router's Device Name* on page 196
- *Set Up and Manage Custom Static Routes* on page 197

Change the Physical WAN Connection Preference

The modem router can autodetect the type of WAN connection. However, you can also set the WAN connection preference manually to either the DSL port or the Ethernet WAN port.

Note The modem router does not support load balancing over DSL and Ethernet WAN interfaces. Only *one* WAN interface (either the DLS port or the Ethernet WAN port) can be active at any time.

► To change the WAN connection preference:

1. Launch a web browser from a computer or mobile device that is connected to the network.
2. Enter **http://www.routerlogin.net**.
A login window opens.
3. Enter the modem router user name and password.
The user name is **admin**. The default password is **password**. The user name and password are case-sensitive.
The BASIC Home page displays.
4. Select **ADVANCED > Setup > WAN Setup**.
The WAN Setup page displays.
5. From the **WAN Preference** menu, select a connection option:
 - **Must use DSL WAN**. The modem router uses the DSL port for a DSL WAN connection. The Internet port is shut down.
 - **Must use Ethernet WAN**. The modem router uses the Internet port for an Ethernet WAN connection. The DSL port is shut down.
6. Click the **Apply** button.
Your settings are saved.

Enable Bridge Mode for IPTV Devices

Some devices, such as an IPTV, cannot function behind the modem router's network address translation (NAT) service or firewall. Based on what your Internet service provider (ISP) requires, for the device to connect to the ISP's network directly, you can enable the bridge between the device and the modem router's virtual IPTV interface. In bridge mode, by default, the LAN 4 port on the back panel of the modem router is bound to the virtual IPTV interface.

In addition to connecting an IPTV device to the LAN 4 port, you can connect an IPTV device to the LAN 3 port and another one to the LAN 2 port. That is, the modem router can support up to three IPTV devices. The LAN 1 port is reserved for a wired Internet connection. Do not connect an IPTV device to the LAN 1 port.

For information about enabling and configuring the virtual IPTV interface, see one of the following sections:

- [Manually Set Up an ADSL Internet Connection](#) on page 49
- [Manually Set Up a VDSL Internet Connection](#) on page 58
- [Manually Set Up a Cable or Fiber Internet Connection](#) on page 66

▶ To enable bridge mode for one or more IPTV devices:

1. Launch a web browser from a computer or WiFi device that is connected to the network.
2. Enter **http://www.routerlogin.net**.
A login window opens.
3. Enter the modem router user name and password.
The user name is **admin**. The default password is **password**. The user name and password are case-sensitive.
The BASIC Home page displays.
4. Select **Internet**.
The Internet Setup page displays.
When you set up your Internet connection (either through NETGEAR genie, through the Setup Wizard, or manually), the country, ISP, transfer mode, and DSL mode were already specified.
5. From the menu above the **Enable This Interface** check box, select **IPTV**.

Internet Setup

Test Cancel Apply

Select Country Germany

Select Internet Service Provider Deutsche Telekom

Transfer Mode VDSL(PTM)

DSL Mode VDSL2

IPTV

Enable This Interface

Multiplexing Method LLC-BASED

VPI

VCI

Use VLANID 8

Priority(0~7) 0

Bridge Mode

(If select Bridge Mode,the LAN4 port will be configured as IPTV port,you can select max.3 LAN ports for 3 IPTV devices to connect to.LAN1 is reserved for wired internet)

Enable IPTV on LAN4

Enable IPTV on LAN3

Enable IPTV on LAN2

6. Make sure that the **Enable This Interface** check box is selected for the virtual IPTV interface.
If you already enabled and configured the virtual IPTV interface, the check box is selected.
7. Select the **Bridge Mode** check box.
By default, the LAN 4 port is bound to the virtual IPTV interface and the **Enable IPTV on LAN4** check box is automatically selected.
8. If you also connected an IPTV device to the LAN 3 port, select the **Enable IPTV on LAN3** check box.
9. If you also connected an IPTV device to the LAN 2 port, select the **Enable IPTV on LAN2** check box.
10. Click the **Apply** button.
Your settings are saved.

Enable and Configure a VLAN

A network of computers and devices can behave as if they were connected to the same network even though they might actually be physically on different segments of a LAN. Virtual LANs (VLANs) are configured through software rather than hardware, which makes them very flexible.

If you enable a VLAN and if the network devices (hubs and switches) on your LAN support the VLAN (802.1Q) standard, the VLAN ID is associated with all traffic coming from the modem router.

If you are subscribed to IPTV service, the modem router might require VLAN tags to distinguish between the Internet traffic and the IPTV traffic.

For information about enabling and configuring the virtual IPTV interface, see one of the following sections:

- *Manually Set Up an ADSL Internet Connection* on page 49
- *Manually Set Up a VDSL Internet Connection* on page 58
- *Manually Set Up a Cable or Fiber Internet Connection* on page 66

Note If your ISP provides directions for how to set up VLANs for IPTV and Internet service, follow those directions.

► To enable and configure a VLAN for the virtual Internet interface and another VLAN for the virtual IPTV interface:

1. Launch a web browser from a computer or WiFi device that is connected to the network.
2. Enter **http://www.routerlogin.net**.
A login window opens.
3. Enter the modem router user name and password.
The user name is **admin**. The default password is **password**. The user name and password are case-sensitive.
The BASIC Home page displays.

4. Select **Internet**.

Internet Setup

Test Cancel Apply

Select Country Germany

Select Internet Service Provider Deutsche Telekom

Transfer Mode VDSL(PTM)

DSL Mode VDSL2

Internet

Enable This Interface

Multiplexing Method LLC-BASED

VPI 8

VCI 35

Use VLANID 7

Priority(0~7) 0

5. Configure a VLAN for the virtual Internet interface:

- a. Make sure that **Internet** is selected from the menu above the **Enable This Interface** check box and that the **Enable This Interface** check box is selected for the virtual Internet interface (it is by default).
- b. Select the **Use VLANID** check box.
- c. Enter a VLAN ID that applies to the virtual Internet interface.
The VLAN ID can be in a range from 0 to 4094. The default VLAN ID is 10.
- d. To specify a priority for the VLAN, in the **Priority (0 ~ 7)** field, enter a value from 0 to 7.
- e. Click the **Apply** button.
Your settings are saved for the virtual Internet interface.

6. From the menu above the **Enable This Interface** check box, select **IPTV**.

The previous figure shows only the top of the Internet Setup page.

7. Configure a VLAN for the virtual IPTV interface:
 - a. Make sure that the **Enable This Interface** check box is selected for the virtual IPTV interface. If you already enabled and configured the virtual IPTV interface, the check box is selected.
 - b. Select the **Use VLANID** check box.
 - c. Enter a VLAN ID that applies to the virtual IPTV interface. The VLAN ID can be in a range from 0 to 4094. The default VLAN ID is 0.
 - d. To specify a priority for the VLAN, in the **Priority (0 ~ 7)** field, enter a value from 0 to 7.
 - e. Click the **Apply** button. Your settings are saved for the virtual IPTV interface.

Note For information about enabling bridge mode for the IPTV virtual interface, see [Enable Bridge Mode for IPTV Devices](#) on page 180.

Set Up a Bridge for a Port Group or VLAN Tag Group

Some devices, such as an IPTV, cannot function behind the modem router's Network Address Translation (NAT) service or firewall. Based on what your Internet service provider (ISP) requires, for the device to connect to the ISP's network directly, you can enable the bridge between the device and the modem router's Internet port or add new VLAN tag groups to the bridge.

Note If your ISP provides directions on how to set up a bridge for IPTV and Internet service, follow those directions.

Set Up a Bridge for a Port Group

If the devices that are connected to the modem router's Ethernet LAN port or WiFi network include an IPTV device, your ISP might require you to set up a bridge for a port group for the modem router's Internet interface.

A bridge with a port group prevents packets that are sent between the IPTV device and the modem router's Internet port from being processed through the modem router's Network Address Translation (NAT) service.

► To configure a port group and enable the bridge:

1. Launch a web browser from a computer or mobile device that is connected to the network.
2. Enter **http://www.routerlogin.net**.
A login window opens.
3. Enter the modem router user name and password.
The user name is **admin**. The default password is **password**. The user name and password are case-sensitive.
The BASIC Home page displays.
4. Select **ADVANCED > Advanced Setup > VLAN/Bridge Settings**.
The VLAN/Bridge Settings page displays.
5. Select the **Enable VLAN/Bridge group** check box.
The page expands.
6. Select the **By bridge group** radio button.

VLAN/Bridge Settings

Enable VLAN/Bridge group

By bridge group

Wired Ports		Wireless	
<input type="checkbox"/> Port1	<input type="checkbox"/> Port2	<input type="checkbox"/> WiFi2.4G	<input type="checkbox"/> WiFi5G
<input type="checkbox"/> Port3	<input type="checkbox"/> Port4		

By VLAN tag group

7. Select a Wired Ports check box or a Wireless check box.
 - If your device is connected to an Ethernet port on the modem router, select the Wired Ports check box that corresponds to the Ethernet port on the modem router to which the device is connected.
 - If your device is connected to your modem router's WiFi network, select the Wireless check box that corresponds to the modem router's WiFi network to which the device is connected.

Note You must select at least one Wired Ports or Wireless check box. You can select more than one check box.

8. Click the **Apply** button.
Your settings are saved.

Set Up a Bridge for a VLAN Tag Group

If the devices that are connected to the modem router's Ethernet LAN ports or WiFi network include an IPTV device, your ISP might require you to set up a bridge for a VLAN tag group for the modem router's Internet interface.

If you are subscribed to IPTV service, the modem router might require VLAN tags to distinguish between the Internet traffic and the IPTV traffic. A bridge with a VLAN tag group prevents packets that are sent between the IPTV device and the modem router's Internet port from being processed through the modem router's Network Address Translation (NAT) service.

You can add VLAN tag groups to a bridge and assign VLAN IDs and priority values to each VLAN tag group.

► To add a VLAN tag group and enable the bridge:

1. Launch a web browser from a computer or mobile device that is connected to the network.
2. Enter **http://www.routerlogin.net**.
A login window opens.
3. Enter the modem router user name and password.
The user name is **admin**. The default password is **password**. The user name and password are case-sensitive.
The BASIC Home page displays.
4. Select **ADVANCED > Advanced Setup > VLAN/Bridge Settings**.
The VLAN/Bridge Settings page displays.
5. Select the **Enable VLAN/Bridge group** check box.

Enable	Name	VLAN ID	Priority	Wired Ports	Wireless
<input checked="" type="checkbox"/>	Internet	-	-	All	All

6. Select the **By VLAN tag group** radio button.

7. Specify the settings as described in the following table.

Field	Description
Name	Enter a name for the VLAN tag group. The name can be up to 10 characters.
VLAN ID	Enter a value from 1 to 4094.
Priority	Enter a value from 0 to 7.
Select the check box for a wired LAN port or WiFi port. If your device is connected to an Ethernet port on the modem router, select the LAN port check box that corresponds to the Ethernet port on the modem router to which the device is connected. If your device is connected to your modem router's WiFi network, select the WiFi check box that corresponds to the modem router's WiFi network to which the device is connected. You must select at least one LAN port or WiFi port. You can select more than one port.	

8. Click the **Add** button.
The VLAN tag group is added.
9. Click the **Apply** button.
Your settings are saved.

Manage the WAN Security Settings

The WAN security settings include port scan protection and denial of service (DoS) protection, which can protect your LAN against attacks such as Syn flood, Smurf Attack, Ping of Death, and many others. By default, DoS protection is enabled and a port scan is rejected.

You can also enable the modem router to respond to a ping to its WAN (Internet) port. This feature allows your modem router to be discovered. Enable this feature only as a diagnostic tool or if a specific reason exists.

► To change the default WAN security settings:

1. Launch a web browser from a computer or mobile device that is connected to the network.
2. Enter <http://www.routerlogin.net>.

A login window opens.

3. Enter the modem router user name and password.

The user name is **admin**. The default password is **password**. The user name and password are case-sensitive.

The BASIC Home page displays.

4. Select **ADVANCED > Setup > WAN Setup**.

The WAN Setup page displays.

5. To enable a port scan and disable DoS protection, clear the **Disable Port Scan and DoS Protection** check box.

6. To enable the modem router to respond to a ping, select the **Respond to Ping on Internet Port** check box.

7. Click the **Apply** button.

Your settings are saved.

Set Up a Default DMZ Server

The default DMZ server feature is helpful when you are using some online games and videoconferencing applications that are incompatible with Network Address Translation (NAT). The modem router is programmed to recognize some of these applications and to work correctly with them, but other applications might not function well. In some cases, one local computer can run the application correctly if the IP address for that computer is entered as the default DMZ server.



WARNING:

DMZ servers pose a security risk. A computer designated as the default DMZ server loses much of the protection of the firewall and is exposed to exploits from the Internet. If compromised, the DMZ server computer can be used to attack other computers on your network.

The modem router usually detects and discards incoming traffic from the Internet that is not a response to one of your local computers or a service or application for which you set up a port forwarding or port triggering rule. Instead of discarding this traffic, you can direct the modem router to forward the traffic to one computer on your network. This computer is called the default DMZ server.

▶ **To set up a default DMZ server:**

1. Launch a web browser from a computer or mobile device that is connected to the network.

2. Enter **http://www.routerlogin.net**.

A login window opens.

3. Enter the modem router user name and password.

The user name is **admin**. The default password is **password**. The user name and password are case-sensitive.

The BASIC Home page displays.

4. Select **ADVANCED > Setup > WAN Setup**.
The WAN Setup page displays.
5. Select the **Default DMZ Server** check box.
6. Enter the IP address of the server.
7. Click the **Apply** button.
Your settings are saved.

Manage IGMP Proxying

IGMP proxying allows a computer on the local area network (LAN) to receive the multicast traffic it is interested in from the Internet. If you do not need this feature, leave it disabled, which is the default setting.

► To enable IGMP proxying:

1. Launch a web browser from a WiFi-enabled computer or mobile device that is connected to the network.
2. Enter **http://www.routerlogin.net**
A login window opens.
3. Enter the modem router user name and password.
The user name is **admin**. The default password is **password**. The user name and password are case-sensitive.
The BASIC Home page displays.
4. Select **ADVANCED > Setup > WAN Setup**.
The WAN Setup page displays.
5. Clear the **Disable IGMP Proxying** check box.
By default, the **Disable IGMP Proxying** check box is selected and IGMP proxying is disabled.
6. Click the **Apply** button.
Your settings are saved.

Manage NAT Filtering

Network Address Translation (NAT) determines how the modem router processes inbound traffic. Secured NAT protects computers on the LAN from attacks from the Internet but might prevent some Internet games, point-to-point applications, or multimedia applications from working. Open NAT provides a much less secured firewall but allows almost all Internet applications to work. Secured NAT is the default setting.

► To change the default NAT filtering settings:

1. Launch a web browser from a computer or mobile device that is connected to the network.
2. Enter **http://www.routerlogin.net**.
A login window opens.

3. Enter the modem router user name and password.
The user name is **admin**. The default password is **password**. The user name and password are case-sensitive.
The BASIC Home page displays.
4. Select **ADVANCED > Setup > WAN Setup**.
The WAN Setup page displays.
5. Select a NAT Filtering radio button:
 - **Secured**. Provides a secured firewall to protect the computers on the LAN from attacks from the Internet but might prevent some Internet games, point-to-point applications, or multimedia applications from functioning. By default, the **Secured** radio button is selected.
 - **Open**. Provides a much less secured firewall but allows almost all Internet applications to function.
6. Click the **Apply** button.
Your settings are saved.

Manage the SIP Application-Level Gateway

The application-level gateway (ALG) for the Session Initiation Protocol (SIP) is enabled by default for enhanced address and port translation. However, some types of VoIP and video traffic might not work well when the SIP ALG is enabled. For this reason, the modem router provides the option to disable the SIP ALG.

► To change the default SIP ALG setting:

1. Launch a web browser from a computer or mobile device that is connected to the network.
2. Enter **http://www.routerlogin.net**.
A login window opens.
3. Enter the modem router user name and password.
The user name is **admin**. The default password is **password**. The user name and password are case-sensitive.
The BASIC Home page displays.
4. Select **ADVANCED > Setup > WAN Setup**.
The WAN Setup page displays.
5. To disable the SIP ALG, select the **Disable SIP ALG** check box.
The SIP ALG is enabled by default.
6. Click the **Apply** button.
Your settings are saved.

Manage the Modem Routers's LAN IP Address Settings

The modem router is preconfigured to use private IP addresses on the LAN side and to act as a DHCP server. The modem router's default LAN IP configuration is as follows:

- **LAN IP address.** 192.168.1.1 (This is the same as www.routerlogin.net and www.routerlogin.com.)
- **Subnet mask.** 255.255.255.0

These addresses are part of the designated private address range for use in private networks and are suitable for most applications. The IP address and subnet mask identify which addresses are local to a specific device and which must be reached through a gateway or modem router. You might want to change these settings if you need a specific IP subnet that one or more devices on the network use, or if competing subnets use the same IP scheme.

► To change the LAN IP address settings:

1. Launch a web browser from a computer or mobile device that is connected to the network.
2. Enter **<http://www.routerlogin.net>**.
A login window opens.
3. Enter the modem router user name and password.
The user name is **admin**. The default password is **password**. The user name and password are case-sensitive.
The BASIC Home page displays.
4. Select **ADVANCED > Setup > LAN Setup**.

LAN Setup [Cancel] [Apply]

Device Name: D7800 [Edit]

LAN TCP/IP Setup

IP Address: 192 . 168 . 1 . 1

IP Subnet Mask: 255 . 255 . 255 . 0

RIP Direction: Both

RIP Version: Disabled

Use Router as DHCP Server

Starting IP Address: 192 . 168 . 1 . 2

Ending IP Address: 192 . 168 . 1 . 254

Address Reservation

#	IP Address	Device Name	MAC Address
[+ Add]	[Edit]	[Delete]	

5. In the **IP Address** fields, enter the LAN IP address for the modem router.
6. In the **IP Subnet Mask** fields, enter the LAN subnet mask for the modem router.
7. Click the **Apply** button.

Your settings are saved.

If you changed the LAN IP address of the modem router, you are disconnected when the changes take effect.

To reconnect, close your browser, relaunch it, and log in to the modem router at its new LAN IP address.

Manage the Router Information Protocol Settings

Router Information Protocol (RIP) lets the modem router exchange routing information with other routers. By default, RIP is enabled in both directions (in and out) without a particular RIP version.

► To manage the RIP settings:

1. Launch a web browser from a computer or mobile device that is connected to the network.
2. Enter **http://www.routerlogin.net**.
A login window opens.
3. Enter the modem router user name and password.
The user name is **admin**. The default password is **password**. The user name and password are case-sensitive.
The BASIC Home page displays.
4. Select **ADVANCED > Setup > LAN Setup**.
The LAN Setup page displays.
5. From the **RIP Direction** menu, select the RIP direction:
 - **Both**. The modem router broadcasts its routing table periodically and incorporates information that it receives. This is the default setting.
 - **Out Only**. The modem router broadcasts its routing table periodically but does not incorporate the RIP information that it receives.
 - **In Only**. The modem router incorporates the RIP information that it receives but does not broadcast its routing table.
6. From the **RIP Version** menu, select the RIP version:
 - **Disabled**. The RIP version is disabled. This is the default setting.
 - **RIP-1**. This format is universally supported. It is adequate for most networks, unless you are using an unusual network setup.
 - **RIP-2**. This format carries more information. Both RIP-2B and RIP-2M send the routing data in RIP-2 format. RIP-2B uses subnet broadcasting. RIP-2M uses multicasting.
7. Click the **Apply** button.
Your settings are saved.

Manage the DHCP Server Address Pool

By default, the modem router acts as a Dynamic Host Configuration Protocol (DHCP) server. The modem router assigns IP, DNS server, and default gateway addresses to all computers that are connected to its LAN and WiFi networks. The assigned default gateway address is the LAN address of the modem router.

These addresses must be part of the same IP address subnet as the modem router's LAN IP address. The default DHCP address pool is 192.168.1.2–192.168.1.254.

The modem router delivers the following parameters to any LAN device that requests DHCP:

- An IP address from the range that you define
- Subnet mask
- Gateway IP address (the modem router's LAN IP address)
- DNS server IP address (the modem router's LAN IP address)

► To specify the pool of IP addresses that the modem router assigns:

1. Launch a web browser from a computer or mobile device that is connected to the network.
2. Enter **http://www.routerlogin.net**.
A login window opens.
3. Enter the modem router user name and password.
The user name is **admin**. The default password is **password**. The user name and password are case-sensitive.
The BASIC Home page displays.
4. Select **ADVANCED > Setup > LAN Setup**.

LAN Setup

Cancel Apply

Device Name D7800 Edit

LAN TCP/IP Setup

IP Address 192 . 168 . 1 . 1

IP Subnet Mask 255 . 255 . 255 . 0

RIP Direction Both

RIP Version Disabled

Use Router as DHCP Server

Starting IP Address 192 . 168 . 1 . 2

Ending IP Address 192 . 168 . 1 . 254

Address Reservation

#	IP Address	Device Name	MAC Address

+ Add Edit Delete

5. Make sure that the **Use Router as DHCP Server** check box is selected.

This check box is selected by default.

6. Specify the range of IP addresses that the modem router assigns:
 - In the **Starting IP Address** field, enter the lowest number in the range.
This IP address must be in the same subnet as the modem router. By default, the starting IP address is 192.168.1.2.
 - In the **Ending IP Address** field, enter the number at the end of the range of IP addresses.
This IP address must be in the same subnet as the modem router. By default, the ending IP address is 192.168.1.254.
7. Click the **Apply** button.
Your settings are saved.

Manage Reserved LAN IP Addresses

When you specify a reserved IP address for a computer on the LAN, that computer always receives the same IP address each time it accesses the modem router's DHCP server.

Reserve a LAN IP Address

You can assign a reserved IP address to a computer or server that requires permanent IP settings.

► To reserve an IP address:

1. Launch a web browser from a computer or mobile device that is connected to the network.
2. Enter **http://www.routerlogin.net**.
A login window opens.
3. Enter the modem router user name and password.
The user name is **admin**. The default password is **password**. The user name and password are case-sensitive.
The BASIC Home page displays.
4. Select **ADVANCED > Setup > LAN Setup**.
The LAN Setup page displays.
5. In the Address Reservation section, click the **Add** button.
The Address Reservation page displays.
6. Either select a device from the Address Reservation Table by selecting the corresponding radio button or specify the reserved IP address information:
 - In the **IP Address** field, enter the IP address to assign to the computer or device.
Choose an IP address from the modem router's LAN subnet, such as 192.168.1.x.
 - In the **MAC Address** field, enter the MAC address of the computer or device.

- In the **Device Name** field, enter the name of the computer or device.

7. Click the **Add** button.

The reserved address is entered into the table on the LAN Setup page.

The reserved address is not assigned until the next time the computer or device contacts the modem router's DHCP server. Reboot the computer or device, or access its IP configuration and force a DHCP release and renew.

Change a Reserved IP Address

You can change a reserved IP address entry.

► **To change a reserved IP address entry:**

1. Launch a web browser from a computer or mobile device that is connected to the network.
2. Enter **http://www.routerlogin.net**.
A login window opens.
3. Enter the modem router user name and password.
The user name is **admin**. The default password is **password**. The user name and password are case-sensitive.
The BASIC Home page displays.
4. Select **ADVANCED > Setup > LAN Setup**.
The LAN Setup page displays.
5. In the Address Reservation section, select the radio button for the reserved address.
6. Click the **Edit** button.
The Address Reservation page displays.
7. Change the settings.
8. Click the **Apply** button.
Your settings are saved.

Remove a Reserved IP Address Entry

You can remove a reserved IP address entry.

► **To remove a reserved IP address entry:**

1. Launch a web browser from a computer or mobile device that is connected to the network.
2. Enter **http://www.routerlogin.net**.
A login window opens.
3. Enter the modem router user name and password.
The user name is **admin**. The default password is **password**. The user name and password are case-sensitive.

The BASIC Home page displays.

4. Select **ADVANCED > Setup > LAN Setup**.

The LAN Setup page displays.

5. In the Address Reservation section, select the radio button for the reserved address.

6. Click the **Delete** button.

The address entry is removed.

Disable the Built-In DHCP Server

By default, the modem router functions as a DHCP server. The modem router assigns IP, DNS server, and default gateway addresses to all devices connected to the LAN. The assigned default gateway address is the LAN address of the modem router.

You can use another device on your network as the DHCP server or specify the network settings of all your computers.

Note If you disable the DHCP server and no other DHCP server is available on your network, you must set your computer IP addresses manually so that they can access the modem router.

► To disable the built-in DHCP server:

1. Launch a web browser from a computer or mobile device that is connected to the network.

2. Enter **http://www.routerlogin.net**.

A login window opens.

3. Enter the modem router user name and password.

The user name is **admin**. The default password is **password**. The user name and password are case-sensitive.

The BASIC Home page displays.

4. Select **ADVANCED > Setup > LAN Setup**.

The LAN Setup page displays.

5. Clear the **Use Router as DHCP Server** check box.

6. Click the **Apply** button.

Your settings are saved.

Change the Modem Router's Device Name

The modem router's device name is D7800.

This device name displays in a file manager when you browse your network.

► To change the modem router's device name:

1. Launch a web browser from a computer or mobile device that is connected to the network.
2. Enter **http://www.routerlogin.net**.
A login window opens.
3. Enter the modem router user name and password.
The user name is **admin**. The default password is **password**. The user name and password are case-sensitive.
The BASIC Home page displays.
4. Select **ADVANCED > Setup > LAN Setup**.
The LAN Setup page displays.
5. Click the upper **Edit** button.
The Device Name page displays.
6. In the **Device Name** field, enter a new name.
7. Click the **Apply** button.
Your settings are saved.

Set Up and Manage Custom Static Routes

Static routes provide detailed routing information to your modem router. Typically, you do not need to add static routes. You must configure static routes only for unusual cases such as when you use multiple routers or multiple IP subnets on your network.

As an example of when a static route is needed, consider the following case:

- Your primary Internet access is through an ADSL modem to an ISP.
- You use an ISDN router on your home network for connecting to the company where you are employed. This router's address on your LAN is 192.168.1.100.
- Your company's network address is 134.177.0.0.

When you first configured your modem router, two implicit static routes were created. A default route was created with your ISP as the gateway and a second static route was created to your local network for all 192.168.1.x addresses. With this configuration, if you attempt to access a device on the 134.177.0.0 network, your modem router forwards your request to the ISP. The ISP forwards your request to the company where you are employed, and the request is likely to be denied by the company's firewall.

In this case, you must define a static route, instructing your modem router that 134.177.0.0 is accessed through the ISDN modem router at 192.168.1.100. Here is an example:

- Through the destination IP address and IP subnet mask, specify that this static route applies to all 134.177.x.x addresses.
- Through the gateway IP address, specify that all traffic for these addresses is forwarded to the ISDN modem router at 192.168.1.100.
- A metric value of 1 works fine because the ISDN modem router is on the LAN.

Set Up a Static Route

You can add a static route to a destination IP address and specify the subnet mask, gateway IP address, and metric.

► To set up a static route:

1. Launch a web browser from a computer or mobile device that is connected to the network.
2. Enter **http://www.routerlogin.net**.
A login window opens.
3. Enter the modem router user name and password.
The user name is **admin**. The default password is **password**. The user name and password are case-sensitive.
The BASIC Home page displays.
4. Select **ADVANCED > Advanced Setup > Static Routes**.
The Static Routes page displays.
5. Click the **Add** button.

The screenshot shows the 'Static Routes' configuration page. At the top, there are 'Cancel' and 'Apply' buttons. Below the title bar, there are several input fields and checkboxes:

- Route Name:** A text input field.
- Private:** A checkbox that is currently unchecked.
- Active:** A checkbox that is currently checked.
- Destination IP Address:** A field with four sub-input boxes separated by dots.
- IP Subnet Mask:** A field with four sub-input boxes separated by dots.
- Gateway IP Address:** A field with four sub-input boxes separated by dots.
- Metric:** A single text input field.

6. To make the route private, select the **Private** check box.
A private static route is not reported in RIP.
7. To prevent the route from becoming active after you click the **Apply** button, clear the **Active** check box.
In some situations, you might want to set up a static route but keep it disabled until a later time. By default, the **Active** check box is selected and a route becomes active after you click the **Apply** button.
8. Enter the settings as described in the following table.

Field	Description
Destination IP Address	Enter the IP address for the final destination of the route.
IP Subnet Mask	Enter the IP subnet mask for the final destination of the route. If the destination is a single host, enter 255.255.255.255 .
Gateway IP Address	Enter the IP address of the gateway. The IP address of the gateway must be on the same LAN segment as the modem router.
Metric	Enter a number from 1 through 15. This value represents the number of routers between your network and the destination. Usually, a setting of 2 or 3 works, but if this is a direct connection, set it to 1.

9. Click the **Apply** button.

Your settings are saved. The static route is added to the table on the Static Routes page.

Change a Static Route

You can change an existing static route.

▶ To change a static route:

1. Launch a web browser from a computer or mobile device that is connected to the network.
2. Enter **http://www.routerlogin.net**.
A login window opens.
3. Enter the modem router user name and password.
The user name is **admin**. The default password is **password**. The user name and password are case-sensitive.
The BASIC Home page displays.
4. Select **ADVANCED > Advanced Setup > Static Routes**.
The Static Routes page displays.
5. In the Static Routes table, select the radio button for the route.
6. Click the **Edit** button.
The page adjusts.
7. Change the settings for the route.
For more information about the settings, see [Set Up a Static Route](#) on page 198.
8. Click the **Apply** button.
The route is updated in the table on the Static Routes page.

Remove a Static Route

You can remove an existing static route that you no longer need.

▶ **To remove a static route:**

1. Launch a web browser from a computer or mobile device that is connected to the network.
2. Enter **http://www.routerlogin.net**.
A login window opens.
3. Enter the modem router user name and password.
The user name is **admin**. The default password is **password**. The user name and password are case-sensitive.
The BASIC Home page displays.
4. Select **ADVANCED > Advanced Setup > Static Routes**.
The Static Routes page displays.
5. In the Static Routes table, select the radio button for the route.
6. Click the **Delete** button.
The route is removed from the table on the Static Routes page.

Manage the Modem Router and Monitor the Traffic 12

This chapter describes how you can manage the settings for administering and maintaining your modem router and monitor the network.

The chapter includes the following sections:

- [Update the Firmware of the Modem Router](#) on page 202
- [Manage the Configuration File of the Modem Router](#) on page 204
- [Recover the admin Password](#) on page 205
- [Return the Modem Router to Its Factory Default Settings](#) on page 206
- [Disable LED Blinking or Turn Off LEDs](#) on page 208
- [View the Status and Statistics of the Modem Router](#) on page 209
- [View Devices Currently on the Network](#) on page 218
- [Manage the Activity Log](#) on page 219
- [Monitor and Meter Internet Traffic](#) on page 220
- [Manage the Modem Router Remotely](#) on page 226

Note For information about changing the admin password, see [Change the admin Password](#) on page 39. For information about setting up password recovery, see [Set Up Password Recovery](#) on page 40.

Update the Firmware of the Modem Router

The modem router firmware is stored in flash memory.

You can check to see if new firmware is available and update the modem router to the new firmware. You can also visit the NETGEAR support website, download the firmware manually, and update the modem router to the new firmware.

Check for New Firmware and Update the Modem Router

For you to check for new firmware, the modem router must be connected to the Internet.

► To check for new firmware and update your modem router:

1. Launch a web browser from a computer or mobile device that is connected to the network.
2. Enter **http://www.routerlogin.net**.
A login window opens.
3. Enter the modem router user name and password.
The user name is **admin**. The default password is **password**. The user name and password are case-sensitive.
The BASIC Home page displays.
4. Select **ADVANCED > Administration > Firmware Update**.
The Firmware Update page displays.
5. Click the **Check** button.
The modem router detects new firmware if any is available and displays a message asking if you want to download and install it.
6. To download and install the new firmware, click the **Yes** button.
The modem router locates the firmware, downloads it, and begins the update.



WARNING:

To avoid the risk of corrupting the firmware, do not interrupt the update. For example, do not close the browser, click a link, or load a new page. Do not turn off the modem router. Wait until the modem router finishes restarting and the Power LED turns solid white.

A progress bar shows the progress of the firmware upload process. The firmware upload process takes several minutes. When the upload is complete, your modem router restarts.

7. Verify that the modem router is running the new firmware version:
 - a. Launch a web browser from a computer or mobile device that is connected to the network.
 - b. Enter **http://www.routerlogin.net**.
A login window opens.
 - c. Enter the modem router user name and password.

Nighthawk X4S AC2600 WiFi VDSL/ADSL Modem Router Model D7800

The user name is **admin**. The default password is **password**. The user name and password are case-sensitive.

The BASIC Home page displays. The firmware version is stated in the top right, under the **Logout** button.

8. Read the new firmware release notes to determine whether you must reconfigure the modem router after updating.

Manually Upload New Firmware and Update the Modem Router

Downloading firmware and updating the modem router are two separate tasks that are combined in the following procedure.

► To download new firmware manually and update your modem router:

1. Visit downloadcenter.netgear.com, locate the support page for your product, and download the new firmware.
2. Read the new firmware release notes to determine whether you must reconfigure the modem router after updating.
3. Launch a web browser from a computer or mobile device that is connected to the network.
4. Enter **http://www.routerlogin.net**.
A login window opens.
5. Enter the modem router user name and password.
The user name is **admin**. The default password is **password**. The user name and password are case-sensitive.
The BASIC Home page displays.
6. Select **ADVANCED > Administration > Firmware Update**.
The Firmware Update page displays.
7. Locate and select the firmware file on your computer:
 - a. Click the **Browse** button.
 - b. Navigate to the firmware file.
The file ends in `.img`. An example of a firmware file name is `D7800-V1.0.0.38.img`.
 - c. Select the firmware file.
8. Click the **Upload** button.



WARNING:

To avoid the risk of corrupting the firmware, do not interrupt the upload. For example, do not close the browser, click a link, or load a new page. Do not turn off the modem router. Wait until the modem router finishes restarting and the Power LED turns solid white.

Nighthawk X4S AC2600 WiFi VDSL/ADSL Modem Router Model D7800

A progress bar shows the progress of the firmware upload process. The firmware upload process takes several minutes. When the upload is complete, your modem router restarts.

9. Verify that the modem router runs the new firmware version:
 - a. Launch a web browser from a computer or mobile device that is connected to the network.
 - b. Enter **http://www.routerlogin.net**.
A login window opens.
 - c. Enter the modem router user name and password.
The user name is **admin**. The default password is **password**. The user name and password are case-sensitive.
The BASIC Home page displays. The version firmware is stated in the top right, under the **Logout** button.

Manage the Configuration File of the Modem Router

The configuration settings of the modem router are stored within the modem router in a configuration file. You can back up (save) this file to your computer or restore it.

Back Up the Settings

You can save a copy of the current configuration settings.

► To back up the modem router's configuration settings:

1. Launch a web browser from a computer or mobile device that is connected to the network.
2. Enter **http://www.routerlogin.net**.
A login window opens.
3. Enter the modem router user name and password.
The user name is **admin**. The default password is **password**. The user name and password are case-sensitive.
The BASIC Home page displays.
4. Select **ADVANCED > Administration > Backup Settings**.
The Backup Settings page displays.
5. Click the **Back Up** button.
6. Choose a location to store the file on your computer.
The name of the backup file is `NETGEAR_D7800.cfg`.
7. Follow the directions of your browser to save the file.

Restore the Settings

If you backed up the configuration file, you can restore the configuration from this file.

▶ To restore configuration settings that you backed up:

1. Launch a web browser from a computer or mobile device that is connected to the network.
2. Enter **http://www.routerlogin.net**.
A login window opens.
3. Enter the modem router user name and password.
The user name is **admin**. The default password is **password**. The user name and password are case-sensitive.
The BASIC Home page displays.
4. Select **ADVANCED > Administration > Backup Settings**.
The Backup Settings page displays.
5. Click the **Browse** button and navigate to and select the saved configuration file.
The name of the backup file from which you can restore the configuration is `NETGEAR_D7800.cfg`.
6. Click the **Restore** button.
The configuration is uploaded to the modem router. When the restoration is complete, the modem router reboots. This process takes about two minutes.



WARNING:

To avoid the risk of corrupting the firmware, do not interrupt the restoration. For example, do not close the browser, click a link, or load a new page. Do not turn off the modem router. Wait until the modem router finishes restarting and the Power LED turns solid white.

Recover the admin Password

We recommend that you enable password recovery if you change the password for the modem router user name admin. Then you can recover the password if it is forgotten. This recovery process is supported in Internet Explorer, Firefox, and Chrome browsers, but not in the Safari browser.

For information about setting up password recovery, see [Set Up Password Recovery](#) on page 40. The following procedure works only if you did set up password recovery.

▶ To recover your password:

1. Launch a web browser from a computer or WiFi device that is connected to the network.
2. Enter **www.routerlogin.net**.
A login window opens.
3. Click the **Cancel** button.

If password recovery is enabled, you are prompted to enter the serial number of the modem router. The serial number is on the product label of the modem router.

4. Enter the serial number of the modem router.
5. Click the **Continue** button.
A page displays requesting the answers to your security questions.
6. Enter the saved answers to your security questions.
7. Click the **Continue** button.
A page displays your recovered password.
8. Click the **Login again** button.
A login window opens.
9. With your recovered password, log in to the modem router.

Return the Modem Router to Its Factory Default Settings

Under some circumstances (for example, if you lost track of the changes that you made to the modem router settings or you move the modem router to a different network), you might want to erase the configuration and reset the modem router to factory default settings.

If you do not know the current IP address of the modem router, first try to use an IP scanner application to detect the IP address before you reset the modem router to factory default settings.

To reset the modem router to factory default settings, you can use either the **Reset** button on the back of the modem router or the Erase function. However, if you cannot find the IP address or lost the password to access the modem router, you must use the **Reset** button.

After you reset the modem router to factory default settings, the user name is admin, the password is password, the LAN IP address is 192.168.0.1 (which is the same as www.routerlogin.net), and the DHCP server is enabled. For a list of factory default settings, see [Factory Settings](#) on page ?.

Use the Reset Button



CAUTION:

This process erases all settings that you configured in the modem router.

► To reset the modem router to factory default settings:

1. On the back of the modem router, locate the **Reset** button to the right of the leftmost antenna.

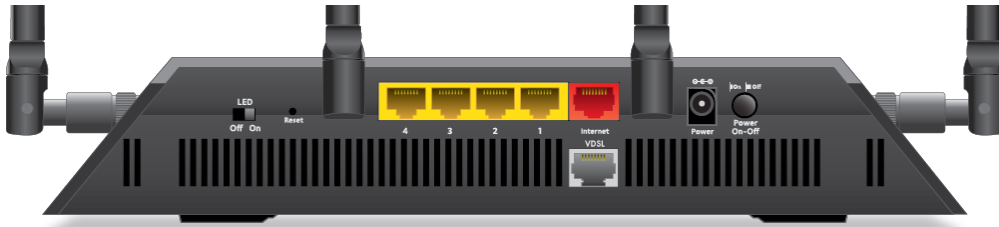

2. Using a straightened paper clip, press and hold the **Reset** button for at least five seconds.
3. Release the **Reset** button.
The Power LED starts blinking amber and the configuration is reset to factory default settings. When the reset is complete, the modem router reboots. This process takes about two minutes.



WARNING:

To avoid the risk of corrupting the firmware, do not interrupt the reset. For example, if you are connected to the modem router's web page, do not close the browser, click a link, or load a new page. Do not turn off the modem router. Wait until the modem router finishes restarting and the Power LED turns solid white.

Erase the Settings



CAUTION:

This process erases all settings that you configured in the modem router.

► To erase the settings:

1. Launch a web browser from a computer or mobile device that is connected to the network.
2. Enter **http://www.routerlogin.net**.
A login window opens.
3. Enter the modem router user name and password.
The user name is **admin**. The default password is **password**. The user name and password are case-sensitive.
The BASIC Home page displays.
4. Select **ADVANCED > Administration > Backup Settings**.

The Backup Settings page displays.

5. Click the **Erase** button.

The configuration is reset to factory default settings. When the reset is complete, the modem router reboots. This process takes about two minutes.



WARNING:

To avoid the risk of corrupting the firmware, do not interrupt the reset. For example, do not close the browser, click a link, or load a new page. Do not turn off the modem router. Wait until the modem router finishes restarting and the Power LED turns solid white.

Disable LED Blinking or Turn Off LEDs

The LEDs on the top panel of the modem router indicate activities and behavior. You can disable LED blinking for network communications, or turn off all LEDs except the Power LED.

► **To disable LED blinking or turn off the LEDs:**

1. Launch a web browser from a computer or WiFi device that is connected to the network.
2. Enter **http://www.routerlogin.net**.
A login window opens.
3. Enter the router user name and password.
The user name is **admin**. The default password is **password**. The user name and password are case-sensitive.
The BASIC Home page displays.
4. Select **ADVANCED > Advanced Setup > LED Control Settings**.

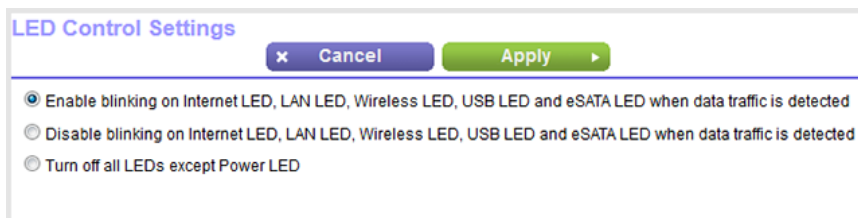

By default, the first radio button is selected, which allows standard LED behavior.

For more information about LEDs, see [Top Panel With LEDs](#) on page 12.

5. To disable blinking, select the **Disable blinking on Internet LED, LAN LED, Wireless LED, USB LED and eSATA LED when data traffic is detected** radio button.
6. To turn off all LEDs except the Power LED, select the **Turn off all LEDs except Power LED** radio button.
7. Click the **Apply** button.
Your settings are saved.

View the Status and Statistics of the Modem Router

You can view information about the modem router and its ports and the status of the Internet connection and WiFi network. In addition, you can view traffic statistics for the various ports.

View Information About the Modem Router and the Internet and WiFi Settings

You can view modem router information, the Internet port status, and WiFi settings.



► **To view information about the modem router and the Internet, modem, and WiFi settings:**

1. Launch a web browser from a computer or WiFi device that is connected to the network.
2. Enter **http://www.routerlogin.net**.
A login window opens.
3. Enter the modem router user name and password.
The user name is **admin**. The default password is **password**. The user name and password are case-sensitive.
The BASIC Home page displays.
4. Select **ADVANCED > ADVANCED Home**.

<p>Router Information</p> <table border="1"> <tr><td>Hardware Version</td><td>D7800</td></tr> <tr><td>Firmware Version</td><td>V1.0.0.38</td></tr> <tr><td>GUI Language Version</td><td>V1.0.0.245</td></tr> <tr><td>Operation Mode</td><td>Router</td></tr> <tr><td colspan="2">LAN Port</td></tr> <tr><td>MAC Address</td><td>A0:63:91:7A:14:98</td></tr> <tr><td>IP Address</td><td>192.168.1.1</td></tr> <tr><td>DHCP Server</td><td>On</td></tr> </table> <p>Reboot</p>	Hardware Version	D7800	Firmware Version	V1.0.0.38	GUI Language Version	V1.0.0.245	Operation Mode	Router	LAN Port		MAC Address	A0:63:91:7A:14:98	IP Address	192.168.1.1	DHCP Server	On	<p>Internet Port</p> <table border="1"> <tr><td>MAC Address</td><td>A0:63:91:7A:14:99</td></tr> <tr><td>IP Address</td><td>192.168.100.168</td></tr> <tr><td>Connection</td><td>DHCP</td></tr> <tr><td>IP Subnet Mask</td><td>255.255.255.0</td></tr> <tr><td>Domain Name Server</td><td>192.168.100.1</td></tr> </table> <p>Show Statistics Connection Status</p>	MAC Address	A0:63:91:7A:14:99	IP Address	192.168.100.168	Connection	DHCP	IP Subnet Mask	255.255.255.0	Domain Name Server	192.168.100.1		
Hardware Version	D7800																												
Firmware Version	V1.0.0.38																												
GUI Language Version	V1.0.0.245																												
Operation Mode	Router																												
LAN Port																													
MAC Address	A0:63:91:7A:14:98																												
IP Address	192.168.1.1																												
DHCP Server	On																												
MAC Address	A0:63:91:7A:14:99																												
IP Address	192.168.100.168																												
Connection	DHCP																												
IP Subnet Mask	255.255.255.0																												
Domain Name Server	192.168.100.1																												
<p>Wireless Settings (2.4GHz)</p> <table border="1"> <tr><td>Name (SSID)</td><td>NETGEAR84</td></tr> <tr><td>Region</td><td>Europe</td></tr> <tr><td>Channel</td><td>Auto (9(s) + 13(p))</td></tr> <tr><td>Mode</td><td>Up to 800 Mbps</td></tr> <tr><td>Wireless AP</td><td>On</td></tr> <tr><td>Broadcast Name</td><td>On</td></tr> <tr><td>Wi-Fi Protected Setup</td><td>Configured</td></tr> </table>	Name (SSID)	NETGEAR84	Region	Europe	Channel	Auto (9(s) + 13(p))	Mode	Up to 800 Mbps	Wireless AP	On	Broadcast Name	On	Wi-Fi Protected Setup	Configured	<p>Wireless Settings (5.0GHz)</p> <table border="1"> <tr><td>Name (SSID)</td><td>NETGEAR84-5G</td></tr> <tr><td>Region</td><td>Europe</td></tr> <tr><td>Channel</td><td>36+40+44(p)+48</td></tr> <tr><td>Mode</td><td>Up to 1733 Mbps</td></tr> <tr><td>Wireless AP</td><td>On</td></tr> <tr><td>Broadcast Name</td><td>On</td></tr> <tr><td>Wi-Fi Protected Setup</td><td>Configured</td></tr> </table>	Name (SSID)	NETGEAR84-5G	Region	Europe	Channel	36+40+44(p)+48	Mode	Up to 1733 Mbps	Wireless AP	On	Broadcast Name	On	Wi-Fi Protected Setup	Configured
Name (SSID)	NETGEAR84																												
Region	Europe																												
Channel	Auto (9(s) + 13(p))																												
Mode	Up to 800 Mbps																												
Wireless AP	On																												
Broadcast Name	On																												
Wi-Fi Protected Setup	Configured																												
Name (SSID)	NETGEAR84-5G																												
Region	Europe																												
Channel	36+40+44(p)+48																												
Mode	Up to 1733 Mbps																												
Wireless AP	On																												
Broadcast Name	On																												
Wi-Fi Protected Setup	Configured																												
<p>Guest Network (2.4GHz)</p> <table border="1"> <tr><td>Name (SSID)</td><td>NETGEAR-Guest</td></tr> <tr><td>Wireless AP</td><td>Off</td></tr> <tr><td>Broadcast Name</td><td>On</td></tr> <tr><td>Allow guests to see each other and access my local network</td><td>Off</td></tr> </table>	Name (SSID)	NETGEAR-Guest	Wireless AP	Off	Broadcast Name	On	Allow guests to see each other and access my local network	Off	<p>Guest Network (5.0GHz)</p> <table border="1"> <tr><td>Name (SSID)</td><td>NETGEAR-5G-Guest</td></tr> <tr><td>Wireless AP</td><td>Off</td></tr> <tr><td>Broadcast Name</td><td>On</td></tr> <tr><td>Allow guests to see each other and access my local network</td><td>Off</td></tr> </table>	Name (SSID)	NETGEAR-5G-Guest	Wireless AP	Off	Broadcast Name	On	Allow guests to see each other and access my local network	Off												
Name (SSID)	NETGEAR-Guest																												
Wireless AP	Off																												
Broadcast Name	On																												
Allow guests to see each other and access my local network	Off																												
Name (SSID)	NETGEAR-5G-Guest																												
Wireless AP	Off																												
Broadcast Name	On																												
Allow guests to see each other and access my local network	Off																												

Nighthawk X4S AC2600 WiFi VDSL/ADSL Modem Router Model D7800

The information onscreen uses the following color coding:

- A green flag  indicates that the cable connection or Internet connection is fine and no problems exist. For a WiFi network, the network is enabled and secured.
- A red X  indicates that configuration problems exist for the cable connection or Internet connection or the connection is down. For a WiFi network, the network is disabled or down.
- An amber exclamation mark  indicates that the cable port or Internet port is configured but cannot get an Internet connection (for example, because the cable is disconnected), that a WiFi network is enabled but unprotected, or that another situation that requires your attention occurred.

The following table describes the fields of the six panes on the ADVANCED Home page.

Field	Description
Router Information	
Hardware Version	The modem router model.
Firmware Version	The version of the modem router firmware. If you upgrade the firmware on the modem router, the version changes.
GUI Language Version	The version of the modem router language for its web pages. If you upgrade the firmware on modem router, the language version might change too.
Operation Mode	The operation mode (Router or AP Mode) of the modem router. For information about how to change the operation mode, see Set Up the Modem Router as a WiFi Access Point Only on page 233.
LAN Port	
The settings of the LAN port. For information about how to configure the LAN settings, see Manage the Modem Routers's LAN IP Address Settings on page 191 and Disable the Built-In DHCP Server on page 196.	
MAC Address	The Media Access Control (MAC) address. This address is the unique physical address that is assigned to the Ethernet LAN port.
IP Address	The IP address that the Ethernet LAN port uses. The default IP address is 192.168.1.1.
DHCP	Displays whether the DHCP server of the modem router is enabled for devices that are attached to the LAN.
Internet Port	
The settings of Internet port. The Internet connection can run through the ADSL port with DSL service or through the WAN Ethernet port with cable or fiber service. For information about how to configure the Internet settings, see one of the following sections:	
<ul style="list-style-type: none"> • Set Up Your Modem Router for DSL Service on page 23 • Set Up the Modem Router for Cable or Fiber Service on page 31 • Manually Set Up an ADSL Internet Connection on page 49 • Manually Set Up a VDSL Internet Connection on page 58 • Manually Set Up a Cable or Fiber Internet Connection on page 66 	

(Continued)

Field	Description
MAC Address	The Media Access Control (MAC) address. This address is the unique physical address that is assigned to the Internet port.
IP Address	The IP address that the Internet port uses. If this field does not display an address or displays 0.0.0.0 as the address, the modem router is not connected to the Internet.
Connection	The type of Internet connection, which can be a PPPoE connection, PPPoA connection, fixed IP address connection, or DHCP connection.
IP Subnet Mask	The IP subnet mask that the Internet port uses.
Domain Name Server	The IP address of the Domain Name System (DNS) server that the Internet uses.
Wireless Settings (2.4GHz)	
<p>The settings of the WiFi port for the 2.4 GHz band of the main network. For information about how to configure the settings of the main network, see the following sections:</p> <ul style="list-style-type: none"> • Manage the Basic WiFi Settings and WiFi Security of the Main Network on page 93 • Control the WiFi Radios on page 108 	
Name (SSID)	The WiFi network name for the 2.4 GHz band of the main network.
Region	The location (country).
Channel	The channel that the 2.4 GHz band of the main network uses.
Mode	The WiFi Mbps settings that the 2.4 GHz band uses for both the main network and guest network.
Wireless AP	Displays whether the 2.4 GHz band of the main network is enabled.
Broadcast Name	Displays whether the 2.4 GHz band of the main network broadcasts its SSID.
Wi-Fi Protected Setup	<p>Displays whether the modem router keeps its existing WiFi settings when you use WPS to connect a device to the 2.4 GHz band of the main network:</p> <ul style="list-style-type: none"> • Configured. The modem router keeps its existing WiFi settings. This is the default setting. • Not configured. The modem router generates a random SSID and passphrase and changes the security mode to WPA/WPA2-PSK mixed mode. For more information, see Manage the WPS Settings on page 230.

(Continued)

Field	Description
<p>Wireless Settings (5.0GHz)</p> <p>The settings of the WiFi port for the 5 GHz band of the main network. For information about how to configure the settings of the main network, see the following sections:</p> <ul style="list-style-type: none"> • Manage the Basic WiFi Settings and WiFi Security of the Main Network on page 93 • Control the WiFi Radios on page 108 	
Name (SSID)	The WiFi network name for the 5 GHz band of the main network.
Region	The location (country).
Channel	The channel that the 5 GHz band of the main network uses.
Mode	The WiFi Mbps settings that the 5 GHz band uses for both the main network and guest network.
Wireless AP	Displays whether the 5 GHz band of the main network is enabled.
Broadcast Name	Displays whether the 5 GHz band of the main network broadcasts its SSID.
Wi-Fi Protected Setup	<p>Displays whether the modem router keeps its existing WiFi settings when you use WPS to connect a device to the 5 GHz band of the main network:</p> <ul style="list-style-type: none"> • Configured. The modem router keeps its existing WiFi settings. This is the default setting. • Not configured. The modem router generates a random SSID and passphrase and changes the security mode to WPA/WPA2-PSK mixed mode. For more information, see Manage the WPS Settings on page 230.
<p>Guest Network (2.4GHz)</p> <p>The settings of the WiFi port for the 2.4 GHz band of the guest network. For information about how to configure the settings of the guest network, see Manage the Basic WiFi Settings and WiFi Security of the Guest Network on page 105.</p>	
Name (SSID)	The WiFi network name for the 2.4 GHz band of the guest network.
Wireless AP	<p>Displays whether the 2.4 GHz band of the guest network is enabled.</p> <p>The WiFi LED on the front of the modem router is not affected by the status of the guest network.</p>
Broadcast Name	Displays whether the 2.4 GHz band of the guest network broadcasts its SSID.
Allow guests to see each other and access my local network	Displays whether users of the 2.4 GHz band of the guest network are allowed to access the main network.

(Continued)

Field	Description
Guest Network (5.0GHz)	
The settings of the WiFi port for the 5 GHz band of the guest network. For information about how to configure the settings of the guest network, see <i>Manage the Basic WiFi Settings and WiFi Security of the Guest Network</i> on page 105.	
Name (SSID)	The WiFi network name for the 5 GHz band of the guest network.
Wireless AP	Displays whether the 2.4 GHz band of the main network is enabled.
Broadcast Name	Displays whether the 5 GHz band of the guest network broadcasts its SSID.
Allow guests to see each other and access my local network	Displays whether users of the 5 GHz band of the guest network are allowed to access the main network.

View the Traffic Statistics

You can view the traffic statistics for the ports of the modem router.

► To view the traffic statistics for the ports of the modem router:

1. Launch a web browser from a computer or mobile device that is connected to the network.
2. Enter **http://www.routerlogin.net**.
A login window opens.
3. Enter the modem router user name and password.
The user name is **admin**. The default password is **password**. The user name and password are case-sensitive.
The BASIC Home page displays.
4. Select **ADVANCED**.
The ADVANCED Home page displays.
5. In the Internet Port pane, click the **Show Statistics** button.
The Show Statistics pop-up window opens.
The following table describes the fields and columns of the Show Statistics pop-up window.

Field or Column	Description
System Up Time	The time elapsed since the modem router was last restarted.
Port	The statistics for the WAN (Internet over Ethernet) port, LAN (Ethernet) ports, WLAN b/g/n port, and WLAN a/n/ac port. For each port, the page displays the information that is described in this table.

(Continued)

Field or Column	Description
Status	The link status of the port.
TxPkts	The number of packets that were transmitted on this port since reset or manual clear.
RxPkts	The number of packets that were received on this port since reset or manual clear.
Collisions	The number of packets that collided on this port since reset or manual clear.
Tx B/s	The number of bytes per second that were transmitted on this port since reset or manual clear.
Rx B/s	The number of bytes per second that were received on this port since reset or manual clear.
Up Time	The time elapsed since this port acquired the link.
DSL Link	
In addition to the xDSL firmware version, the page displays the ADSL link information that is described in this table.	
Connection Speed	The downstream and upstream connection speed rates in Mbps.
Line Attenuation	The downstream and upstream line attenuation (LATN) in dB. The LATN expresses the signal quality.
Noise Margin	The downstream and upstream signal-to-noise ratio margin (SNRM) in dB. The SNRM expresses the signal quality in relation to interference.
Poll Interval	The interval at which the statistics are updated on this page.

Change the Traffic Statistics Polling Frequency

You can change the polling frequency or stop traffic polling.

► To change the traffic statistics polling frequency or stop polling:

1. Launch a web browser from a computer or mobile device that is connected to the network.
2. Enter **http://www.routerlogin.net**.
A login window opens.
3. Enter the modem router user name and password.
The user name is **admin**. The default password is **password**. The user name and password are case-sensitive.
The BASIC Home page displays.
4. Select **ADVANCED**.

The ADVANCED Home page displays.

5. In the Internet Port pane, click the **Show Statistics** button.
A pop-up window displays.
6. Change the polling frequency or stop polling:
 - To change the polling frequency, do the following:
 - a. In the **Poll Interval** field, enter a time in seconds.
 - b. Click the **Set Interval** button.
 - To stop polling, click the **Stop** button.

View, Renew, or Release the TCP/IP Internet Connection

You can view information about a TCP/IP Internet connection of the modem router and renew or release such a connection. This information displays only if the modem router connects to the ISP network over a TCP/IP connection. Such a connection usually functions over an Ethernet WAN connection.

► To view the status of the TCP/IP Internet connection or renew or release the TCP/IP Internet connection:

1. Launch a web browser from a computer or mobile device that is connected to the network.
2. Enter **http://www.routerlogin.net**.
A login window opens.
3. Enter the modem router user name and password.
The user name is **admin**. The default password is **password**. The user name and password are case-sensitive.
The BASIC Home page displays.
4. Select **ADVANCED**.
The ADVANCED Home page displays.
5. In the Internet Port pane, click the **Connection Status** button.
The Connection Status pop-up window opens. The fields that display depend on the type of Internet connection.

The following table describes the fields for a TCP/IP connection with DHCP.

Field	Description
IP Address	The IP address that is assigned by the ISP to the modem router.
Subnet Mask	The subnet mask that is assigned by the ISP to the modem router.
Default Gateway	The IP address of the default gateway of the ISP that the modem router communicates with.

(Continued)

Field	Description
DHCP Server	The IP address of the DHCP server of the ISP that issues the IP address to the modem router.
DNS Server	The IP address of the Domain Name System (DNS) server of the ISP that provides translation of network names to IP addresses.
Lease Obtained	The time at which the modem router obtained the DHCP lease. (The type of DHCP connection determines whether this field displays onscreen.)
Lease Expires	The time at which the DHCP lease expires. (The type of DHCP connection determines whether this field displays onscreen.)

6. To renew the Internet connection when the connection is active, click the **Renew** button.
7. To terminate the Internet connection when the connection is active, click the **Release** button.
8. Click the **Close Window** button.
The pop-up window closes.

View, Establish, or Terminate the PPPoE or PPPoA Internet Connection

You can view information about a PPPoE or PPPoA Internet connection of the modem router and establish or terminate such a connection. This information displays only if the modem router connects to the ISP network over a PPPoE or PPPoA connection. A PPPoE connection can function over an ADSL, VDSL, or cable connection. A PPPoA connection can function only over a VDSL connection.

► To view the status of the PPPoE or PPPoA Internet connection or establish or terminate the PPPoE or PPPoA Internet connection:

1. Launch a web browser from a computer or mobile device that is connected to the network.
2. Enter **http://www.routerlogin.net**.
A login window opens.
3. Enter the modem router user name and password.
The user name is **admin**. The default password is **password**. The user name and password are case-sensitive.
The BASIC Home page displays.
4. Select **ADVANCED**.
The ADVANCED Home page displays.
5. In the Internet Port pane, click the **Connection Status** button.
The Connection Status pop-up window opens. The fields that display depend on the type of Internet connection.

Nighthawk X4S AC2600 WiFi VDSL/ADSL Modem Router Model D7800

The following table describes the fields for a PPPoE connection.

Field	Description
Connection Time	The time elapsed since the connection was established.
Connection Status	The status can be Connected or Disconnected.
Negotiation	The negotiation can be a series of dashes, which indicates that the connection is not established, or successful (Success).
Authentication	The authentication can be a series of dashes, which indicates that the connection is not established, or successful (Success).
IP Address	The IP address that is assigned by the ISP to the modem router.
Subnet Mask	The subnet mask that is assigned by the ISP to the modem router.

6. To establish the Internet connection when the connection is down, click the **Connect** button.
7. To terminate the Internet connection when the connection is active, click the **Disconnect** button.
8. Click the **Close Window** button.
The pop-up window closes.

View, Establish, or Terminate the PPTP or L2TP Internet Connection

You can view information about a PPTP or L2TP Internet connection of the modem router and establish or terminate such a connection. This information displays only if the modem router connects to the ISP network over a PPTP or L2TP connection. A PPTP or L2TP connection can function only over an Ethernet WAN connection.

► To view the status of the PPTP or L2TP Internet connection or establish or terminate the PPTP or L2TP Internet connection:

1. Launch a web browser from a computer or mobile device that is connected to the network.
2. Enter **http://www.routerlogin.net**.
A login window opens.
3. Enter the modem router user name and password.
The user name is **admin**. The default password is **password**. The user name and password are case-sensitive.
The BASIC Home page displays.
4. Select **ADVANCED**.
The ADVANCED Home page displays.
5. In the Internet Port pane, click the **Connection Status** button.
The Connection Status pop-up window opens. The fields that display depend on the type of Internet connection.

Field	Description
IP Address	The IP address that is assigned by the ISP to the modem router.
Subnet Mask	The subnet mask that is assigned by the ISP to the modem router.

6. To establish the Internet connection when the connection is down, click the **Connect** button.
7. To terminate the Internet connection when the connection is active, click the **Disconnect** button.
8. Click the **Close Window** button.
The pop-up window closes.

View Devices Currently on the Network

You can view the active wired and WiFi devices in both the network to which the modem router is connected and the modem router network. If you do not recognize a WiFi device, it might be an intruder.

► To display the wired and WiFi devices and change the device name, device type, or both:

1. Launch a web browser from a computer or WiFi device that is connected to the network.
2. Enter **http://www.routerlogin.net**.
A login window opens.
3. Enter the modem router user name and password.
The user name is **admin**. The default password is **password**. The user name and password are case-sensitive.
The BASIC Home page displays.
4. Select **Attached Devices**.
The Attached Devices page displays.
Wired devices are connected to the modem router with Ethernet cables. WiFi devices are connected to the modem router through the WiFi network, in either the 2.4 GHz band or the 5 GHz band.
5. To display the MAC address, type of device, and the SSID to which the device is connected, point to the device icon.
6. To change the device name, device type, or both, do the following:
 - a. Click the device icon.
The Edit Device page displays.
 - b. To change the device name, in the **Device Name** field, type a new device name.
The new device name is for display on the modem router only.
 - c. To change the device type, from the **Device Type** menu, select another device type.
The device icon changes.
 - d. Click the **Apply** button.

Your settings are saved.

Manage the Activity Log

The log is a detailed record of the websites users on your network accessed or attempted to access and many other modem router actions. Up to 256 entries are stored in the log. You can manage which activities are logged.

View, Email, or Clear the Logs

In addition to viewing the logs, you can email them and clear them.

► To view, email, or clear the logs:

1. Launch a web browser from a computer or mobile device that is connected to the network.
2. Enter **http://www.routerlogin.net**.
A login window opens.
3. Enter the modem router user name and password.
The user name is **admin**. The default password is **password**. The user name and password are case-sensitive.
The BASIC Home page displays.
4. Select **ADVANCED > Administration > Logs**.
The Logs page shows the following information:
 - **Action**. The action that occurred, such as whether Internet access was blocked or allowed.
 - **Source**. The name, IP address, or MAC address of the target device, application, or website for this log entry.
 - **Target**. The name, IP address, or MAC address of the target device, application, or website for this log entry.
 - **Date and Time**. The date and time at which the action occurred.
5. To refresh the log entries onscreen, click the **Refresh** button.
6. To clear the log entries, click the **Clear Log** button.
7. To email the log immediately, click the **Send Log** button.
The modem router emails the logs to the address that you specified (see *Set Up Security Event Email Notifications* on page 129).

Specify Which Activities Are Logged

You can specify which activities are logged. These activities display in the log and are forwarded to the syslog server if you enabled the syslog server function.

► **To manage which activities are logged:**

1. Launch a web browser from a computer or mobile device that is connected to the network.
2. Enter **http://www.routerlogin.net**.
A login window opens.
3. Enter the modem router user name and password.
The user name is **admin**. The default password is **password**. The user name and password are case-sensitive.
The BASIC Home page displays.
4. Select **ADVANCED > Administration > Logs**.
The Logs page displays.
5. Select the check boxes that correspond to the activities that you want to be logged.
By default, all check boxes are selected.
6. Clear the check boxes that correspond to the activities that you do not want to be logged.
7. Click the **Apply** button.
Your settings are saved.

Monitor and Meter Internet Traffic

Traffic metering allows you to monitor the volume of Internet traffic that passes through the modem router Internet port. With the traffic meter utility, you can set limits for traffic volume, set a monthly limit, and get a live update of traffic usage.

Start the Traffic Meter Without Traffic Volume Restrictions

You can monitor the traffic volume without setting a limit.

► **To start or restart the traffic meter without configuring traffic volume restrictions:**

1. Launch a web browser from a computer or mobile device that is connected to the network.
2. Enter **http://www.routerlogin.net**.
A login window opens.
3. Enter the modem router user name and password.
The user name is **admin**. The default password is **password**. The user name and password are case-sensitive.
The BASIC Home page displays.

4. Select **ADVANCED > Advanced Setup > Traffic Meter**.

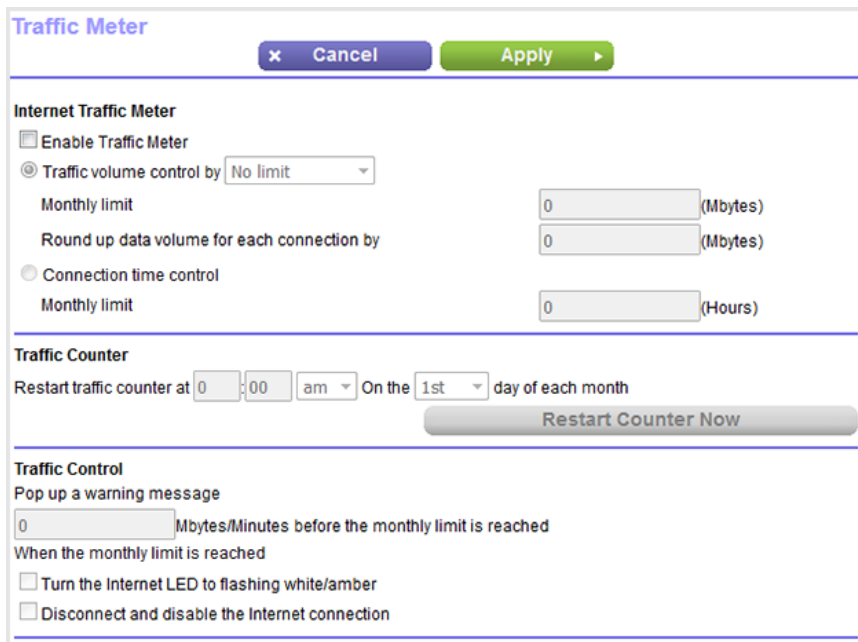

5. Select the **Enable Traffic Meter** check box.
By default, no traffic limit is specified and the traffic volume is not controlled.
6. In the Traffic Counter section, set the traffic counter to begin at a specific time and date.
7. To start the traffic counter immediately, click the **Restart Counter Now** button.
8. Click the **Apply** button.

Your settings are saved and the modem router restarts.

The Internet Traffic Statistics section helps you to monitor the data traffic. For more information, see [View the Internet Traffic Volume and Statistics](#) on page 221.

View the Internet Traffic Volume and Statistics

If you enabled the traffic meter (see [Start the Traffic Meter Without Traffic Volume Restrictions](#) on page 220), you can view the Internet traffic volume and statistics.

► To view the Internet traffic volume and statistics shown by the traffic meter:

1. Launch a web browser from a computer or mobile device that is connected to the network.
2. Enter **http://www.routerlogin.net**.
A login window opens.
3. Enter the modem router user name and password.
The user name is **admin**. The default password is **password**. The user name and password are case-sensitive.
The BASIC Home page displays.

4. Select **ADVANCED > Advanced Setup > Traffic Meter**.

The Traffic Meter page displays.

5. Scroll down to the Internet Traffic Statistics section.

Internet Traffic Statistics
 Start Date/Time: Monday, 22 Jun 2015 10:10 AM
 Current Date/Time: Monday, 22 Jun 2015 10:20 AM
 Traffic Volume Left: No limit

Period	Connection Time (hh:mm)	Traffic Volume (Mbytes)		
		Upload/Avg	Download/Avg	Total/Avg
Today	---	0.77	7.43	8.19
Yesterday	---	0.00	0.00	0.00
This week	---	0.77/0.11	7.43/1.06	8.19/1.17
This month	---	0.77/0.03	7.43/0.25	8.19/0.27
Last month	---	0.00/0.00	0.00/0.00	0.00/0.00

The Internet Traffic Statistics section displays when the traffic counter was started and what the traffic balance is. The table displays information about the connection time and traffic volume in MB.

6. To refresh the information onscreen, click the **Refresh** button.
The information is updated.
7. To display more information about the data traffic and to change the polling interval, click the **Traffic Status** button.
The Traffic Status pop-up window displays.

Restrict Internet Traffic by Volume

You can record and restrict the traffic by volume in MB. This is useful when your ISP measures your traffic in volume.

▶ To record and restrict the Internet traffic by volume:

1. Launch a web browser from a computer or mobile device that is connected to the network.
2. Enter **http://www.routerlogin.net**.
A login window opens.
3. Enter the modem router user name and password.
The user name is **admin**. The default password is **password**. The user name and password are case-sensitive.
The BASIC Home page displays.

4. Select **ADVANCED > Advanced Setup > Traffic Meter**.

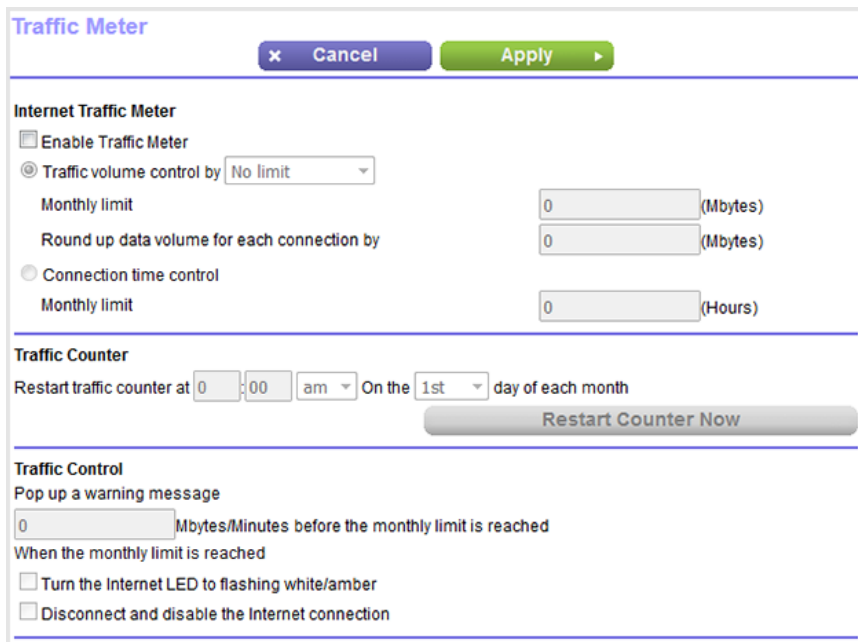

5. Select the **Enable Traffic Meter** check box.
6. Select the **Traffic volume control by** radio button.
7. From the corresponding menu, select an option:
 - **Download only.** The restriction is applied to incoming traffic only.
 - **Both Directions.** The restriction is applied to both incoming and outgoing traffic.
8. In the **Monthly Limit** field, enter how many MBytes (MB) per month are allowed.
9. If your ISP charges you for extra data volume when you make a new connection, enter the extra data volume in MB in the **Round up data volume for each connection by** field.
10. In the Traffic Counter section, set the traffic counter to begin at a specific time and date.
11. In the Traffic Control section, enter a value in minutes to specify when the modem router issues a warning message before the monthly limit in hours is reached.
This setting is optional. The modem router issues a warning when the balance falls below the number of minutes that you enter. By default, the value is 0 and no warning message is issued.
12. Select one or more of the following actions to occur when the limit is reached:
 - **Turn the Internet LED to flashing white/amber.** This setting is optional. When the traffic limit is reached, the Internet LED blinks alternating white and amber.
 - **Disconnect and disable the Internet connection.** This setting is optional. When the traffic limit is reached, the Internet connection is disconnected and disabled.
13. Click the **Apply** button.
Your settings are saved and the modem router restarts.

The Internet Traffic Statistics section helps you to monitor the data traffic. For more information, see [View the Internet Traffic Volume and Statistics](#) on page 221.

Restrict Internet Traffic by Connection Time

You can record and restrict the traffic by connection time. This is useful when your ISP measures your connection time.

► **To record and restrict the Internet traffic by connection time:**

1. Launch a web browser from a computer or mobile device that is connected to the network.
2. Enter **http://www.routerlogin.net**.
A login window opens.
3. Enter the modem router user name and password.
The user name is **admin**. The default password is **password**. The user name and password are case-sensitive.
The BASIC Home page displays.
4. Select **ADVANCED > Advanced Setup > Traffic Meter**.

The screenshot shows the 'Traffic Meter' configuration page. At the top, there are 'Cancel' and 'Apply' buttons. The page is divided into three main sections:

- Internet Traffic Meter:**
 - Enable Traffic Meter
 - Traffic volume control by No limit (dropdown)
 - Monthly limit: (Mbytes)
 - Round up data volume for each connection by: (Mbytes)
 - Connection time control
 - Monthly limit: (Hours)
- Traffic Counter:**
 - Restart traffic counter at : am On the day of each month
 -
- Traffic Control:**
 - Pop up a warning message: Mbytes/Minutes before the monthly limit is reached
 - When the monthly limit is reached:
 - Turn the Internet LED to flashing white/amber
 - Disconnect and disable the Internet connection

5. Select the **Enable Traffic Meter** check box.
6. Select the **Connection time control** radio button.

Note The modem router must be connected to the Internet for you to be able to select the **Connection time control** radio button.

7. In the **Monthly Limit** field, enter how many hours per month are allowed.

Note The modem router must be connected to the Internet for you to be able to enter information in the **Monthly Limit** field.

8. In the Traffic Counter section, set the traffic counter to begin at a specific time and date.
9. In the Traffic Control section, enter a value in minutes to specify when the modem router issues a warning message before the monthly limit in hours is reached.
This setting is optional. The modem router issues a warning when the balance falls under the number of minutes that you enter. By default, the value is 0 and no warning message is issued.
10. Select one or more of the following actions to occur when the limit is reached:
 - **Turn the Internet LED to flashing white/amber.** This setting is optional. When the traffic limit is reached, the Internet LED alternates blinking white and amber.
 - **Disconnect and disable the Internet connection.** This setting is optional. When the traffic limit is reached, the Internet connection is disconnected and disabled.
11. Click the **Apply** button.
Your settings are saved and the modem router restarts.
The Internet Traffic Statistics section helps you to monitor the data traffic. For more information, see [View the Internet Traffic Volume and Statistics](#) on page 221.

Unblock the Traffic Meter After the Traffic Limit Is Reached

If you configured the traffic meter to disconnect and disable the Internet connection after the traffic limit is reached, you cannot access the Internet until you unblock the traffic meter.



CAUTION:

If your ISP set a traffic limit, your ISP might charge you for the overage traffic.

► To unblock the traffic meter:

1. Launch a web browser from a computer or mobile device that is connected to the network.
2. Enter **http://www.routerlogin.net**.
A login window opens.
3. Enter the modem router user name and password.
The user name is **admin**. The default password is **password**. The user name and password are case-sensitive.
The BASIC Home page displays.
4. Select **ADVANCED > Advanced Setup > Traffic Meter**.
The Traffic Meter page displays.
5. In the Traffic Control section, clear the **Disconnect and disable the Internet connection** check box.
6. Click the **Apply** button.
Your settings are saved and the modem router restarts.

Manage the Modem Router Remotely

The remote management feature lets you access your modem router securely over the Internet to view or change its settings. You must know the modem router's WAN IP address to use this feature.

For information about a different type of remote access, that is, remote access using Dynamic DNS, see *Access Storage Devices Through the Internet* on page 162.

Note Be sure to change the password for the user name admin to a secure password. The ideal password contains no dictionary words from any language and contains uppercase and lowercase letters, numbers, and symbols. It can be up to 30 characters. See *Change the admin Password* on page 39.

► To set up remote management:

1. Launch a web browser from a computer or mobile device that is connected to the network.
2. Enter **http://www.routerlogin.net**.
A login window opens.
3. Enter the modem router user name and password.
The user name is **admin**. The default password is **password**. The user name and password are case-sensitive.
The BASIC Home page displays.
4. Select **ADVANCED > Advanced Setup > Remote Management**.

5. Select the **Turn Remote Management On** check box.
6. In the Allow Remote Access By section, specify the external IP addresses to be allowed to access the modem router's remote management.

Note For enhanced security, restrict access to as few external IP addresses as practical.

Select one of the following radio buttons and configure the options accordingly:

Nighthawk X4S AC2600 WiFi VDSL/ADSL Modem Router Model D7800

- To allow access from a single IP address on the Internet, select the **Only This Computer** radio button. Enter the IP address to be allowed access.
 - To allow access from a range of IP addresses on the Internet, select the **IP Address Range** radio button. Enter a beginning and ending IP address to define the allowed range.
 - To allow access from any IP address on the Internet, select the **Everyone** radio button. This radio button is selected by default.
7. Specify the port number for accessing the modem router's web pages.
The default is 8443, which is a common alternate for HTTPS. For greater security, enter a custom port number for accessing the modem router's web pages remotely. Choose a number from 1024 to 65535, but do not use the number of any common service port.
 8. Click the **Apply** button.
Your settings are saved.

This chapter describes how you can manage the advanced WiFi features of the modem router. For information about the basic WiFi settings, see [Manage the Basic WiFi Network Settings](#) on page 92.

The chapter includes the following sections:

- [Set Up a WiFi Schedule](#) on page 229
- [Manage the WPS Settings](#) on page 230
- [Manage Advanced WiFi Settings](#) on page 231
- [Set Up the Modem Router as a WiFi Access Point Only](#) on page 233
- [Set Up a WiFi Bridge](#) on page 234

For information about setting up an access control list (ACL) and managing WiFi access for enhanced security, see [Manage Network Access Control Lists](#) on page 115.

Set Up a WiFi Schedule

You can use this feature to turn off the WiFi signal from your modem router at times when you do not need a WiFi connection. For example, you might turn it off for the weekend if you leave town. You can set up a separate WiFi schedule for each WiFi band.

Note You can set up a WiFi schedule only if the modem router is connected to the Internet and synchronizes its internal clock with a time server on the Internet. For more information about whether the modem router synchronizes its clock, see [Set Up a Schedule for Keyword Blocking and Outbound Firewall Rules](#) on page 127.

► To set up the WiFi schedule for a WiFi band:

1. Launch a web browser from a computer or mobile device that is connected to the network.
2. Enter **http://www.routerlogin.net**.
A login window opens.
3. Enter the modem router user name and password.
The user name is **admin**. The default password is **password**. The user name and password are case-sensitive.
The BASIC Home page displays.
4. Select **ADVANCED > Advanced Setup > Wireless Settings**.

Advanced Wireless Settings [Cancel] [Apply]

Advanced Wireless Settings (2.4GHz b/g/n)

Enable Wireless Router Radio

Enable 20/40 MHz Coexistence

CTS/RTS Threshold (1-2347)

Preamble Mode

Transmit Power Control

Turn off wireless signal by schedule

The wireless signal is scheduled to turn off during the following time period:

Period	Start	End	Recurrence Pattern

[Add a new period] [Edit] [Delete]

Advanced Wireless Settings (5GHz 802.11a/n/ac)

Enable Wireless Router Radio

CTS/RTS Threshold (1-2347)

Preamble Mode

Transmit Power Control

Turn off wireless signal by schedule

The wireless signal is scheduled to turn off during the following time period:

Period	Start	End	Recurrence Pattern

[Add a new period] [Edit] [Delete]

5. In the Advanced Wireless Settings section for the 2.4 GHz band or the 5 GHz band, click the **Add a new period** button.

Advanced Wireless Settings

When to turn off wireless signal

Start: ▼

End: ▼

Recurrence Pattern

Daily

Select Days

Sunday Monday Tuesday Wednesday

Thursday Friday Saturday

6. Use the menus, radio buttons, and check boxes to set up a period during which you want to turn off the WiFi signal and specify whether the schedule is recurrent.
7. Click the **Apply** button.
The Advanced Wireless Settings page displays.
8. Select the **Turn off wireless signal by schedule** check box to activate the schedule.
9. Click the **Apply** button.
Your settings are saved.

Manage the WPS Settings

Wi-Fi Protected Setup (WPS) lets you join the WiFi network without typing the WiFi password. You can change the WPS default settings.

► To manage WPS settings:

1. Launch a web browser from a computer or WiFi device that is connected to the network.
2. Enter **http://www.routerlogin.net**.
A login window opens.
3. Enter the modem router user name and password.
The user name is **admin**. The default password is **password**. The user name and password are case-sensitive.
The BASIC Home page displays.
4. Select **ADVANCED > Advanced Setup > Wireless Settings**.
The Advanced Wireless Settings page displays.

5. Scroll down to the bottom of the page.

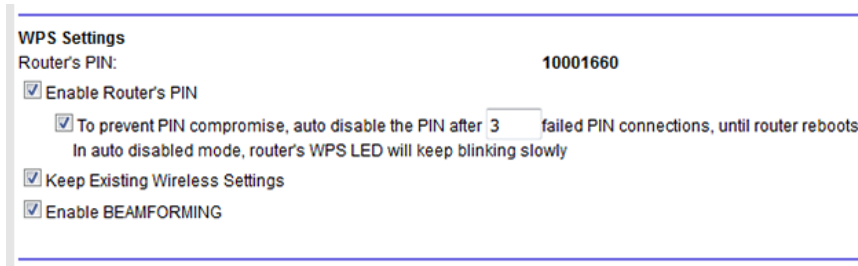

WPS Settings

Router's PIN: 10001660

Enable Router's PIN

To prevent PIN compromise, auto disable the PIN after 3 failed PIN connections, until router reboots.
In auto disabled mode, router's WPS LED will keep blinking slowly

Keep Existing Wireless Settings

Enable BEAMFORMING

The Router's PIN field displays the fixed PIN that you use to configure the modem router's WiFi settings from another platform through WPS.

6. To disable the PIN, clear the **Enable Router's PIN** check box.

By default, the **Enable Router's PIN** check box is selected and the modem router's PIN is enabled. For enhanced security, you can disable the modem router's PIN by clearing the **Enable Router's PIN** check box. However, when you disable the modem router's PIN, WPS is not disabled because you can still use the physical **WPS** button.

Note The PIN function might temporarily be disabled automatically if the modem router detects suspicious attempts to break into the modem router's WiFi settings by using the router's PIN through WPS.

7. To allow the WiFi settings to be changed automatically when you use WPS, clear the **Keep Existing Wireless Settings** check box.

By default, the **Keep Existing Wireless Settings** check box is selected. We recommend that you leave this check box selected. If you clear this check box, the next time a new WiFi client uses WPS to connect to the modem router, the modem router WiFi settings change to an automatically generated random SSID and passphrase. For information about viewing this SSID and passphrase, see [View or Change the Basic WiFi Settings](#) on page 93. Clear the **Keep Existing Wireless Settings** check box only if you want to allow the WPS process to change the SSID and passphrase for WiFi access.



WARNING:

If you clear the **Keep Existing Wireless Settings** check box and use WPS to add a computer or WiFi device to the modem router's WiFi network, the SSID and passphrase are automatically generated and other WiFi devices that are already connected to the modem router's WiFi network might be disconnected.

8. Click the **Apply** button.
Your settings are saved.

Manage Advanced WiFi Settings

For most WiFi networks, the advanced WiFi settings work fine and you do not need to change the settings.

Nighthawk X4S AC2600 WiFi VDSL/ADSL Modem Router Model D7800

Tip If you want to change the WiFi settings of the modem router's main network, use a wired connection to avoid being disconnected when the new WiFi settings take effect.

► To manage advanced WiFi features:

1. Launch a web browser from a computer or WiFi device that is connected to the network.
2. Enter **http://www.routerlogin.net**.
A login window opens.
3. Enter the modem router user name and password.
The user name is **admin**. The default password is **password**. The user name and password are case-sensitive.
The BASIC Home page displays.
4. Select **ADVANCED > Advanced Setup > Wireless Settings**.

Advanced Wireless Settings

Cancel Apply

Advanced Wireless Settings (2.4GHz b/g/n)

Enable Wireless Router Radio

Enable 20/40 MHz Coexistence

CTS/RTS Threshold (1-2347) 2347

Preamble Mode Automatic

Transmit Power Control 100%

Turn off wireless signal by schedule

The wireless signal is scheduled to turn off during the following time period:

Period	Start	End	Recurrence Pattern
--------	-------	-----	--------------------

Add a new period Edit Delete

Advanced Wireless Settings (5GHz 802.11a/n/ac)

Enable Wireless Router Radio

CTS/RTS Threshold (1-2347) 2347

Preamble Mode Automatic

Transmit Power Control 100%

Turn off wireless signal by schedule

The wireless signal is scheduled to turn off during the following time period:

Period	Start	End	Recurrence Pattern
--------	-------	-----	--------------------

Add a new period Edit Delete

5. Enter the settings as described in the following table.
With the exception of Enable 20/40 MHz Coexistence, the descriptions in the table (not the settings onscreen) apply to both the Advanced Wireless Settings (2.4GHz b/g/n) section and the Advanced Wireless Settings (5GHz 802.11a/n/ac) section.

Nighthawk X4S AC2600 WiFi VDSL/ADSL Modem Router Model D7800

Field	Description
Enable 20/40 MHz Coexistence	<p>By default, 20/40 MHz coexistence is enabled to prevent interference between WiFi networks in your environment at the expense of the WiFi speed. If no other WiFi networks are present in your environment, you can clear the Enable 20/40 MHz Coexistence check box to increase the WiFi speed to the maximum supported speed.</p> <hr/> <p>Note This setting applies to the 2.4 GHz band only.</p> <hr/>
CTS/RTS Threshold (1-2347)	<p>The CTS/RTS threshold (the default is 2347) and the preamble mode (the default is Automatic) are reserved for WiFi testing and advanced configuration only. Do not change these settings unless directed by NETGEAR support or unless you are sure what the consequences are. Incorrect settings might disable the WiFi function of the modem router unexpectedly.</p>
Preamble Mode	
Transmit Power Control	<p>You can lower the WiFi transmit power by selecting a value lower than 100% from the Transmit Power Control menu.</p> <p>The setting of 100% allows the modem router to use the maximum WiFi transmit power to transmit WiFi packets. Reducing the transmit power can save the power consumption for the modem router but also reduces the WiFi coverage. If you want to ensure maximum WiFi coverage, we recommend that you leave the setting on the Transmit Power Control menu at 100%.</p>

6. Click the **Apply** button.
Your settings are saved.

Set Up the Modem Router as a WiFi Access Point Only

By default, the modem router functions as a modem, router, and WiFi access point (AP). You can change the operation mode to a mode in which the modem router functions as a standalone AP on your existing network. For AP mode, you must connect the modem router to the router on your existing network. In AP mode, features such as routing, firewall, and traffic meter are disabled on the modem router because these functions, if supported, are performed by the router.

Note To avoid interference with the router to which you connect the modem router, we recommend that you use different WiFi settings on the modem router functioning in AP mode and the router. You can also turn off the WiFi radio on the router and use the modem router only for WiFi client access.

► To set up the modem router as an AP:

1. Use an Ethernet cable to connect the red Internet port of the modem router to a LAN port on the router.
2. Launch a web browser from a computer or WiFi device that is connected to the network.
3. Enter **http://www.routerlogin.net**.
A login window opens.
4. Enter the modem router user name and password.

Manage the Advanced WiFi Features

Nighthawk X4S AC2600 WiFi VDSL/ADSL Modem Router Model D7800

The user name is **admin**. The default password is **password**. The user name and password are case-sensitive.

The BASIC Home page displays.

5. Select **ADVANCED > Advanced Setup > Router / AP Mode**.

The Router / AP Mode page displays.

6. Select the **AP Mode** radio button.

The page adjusts to display the AP Mode details.

We recommend that when you use AP mode, you let the modem router get its IP address dynamically from your existing router. However, if you are sure that must use a static IP address, you can specify a static IP address from your existing router's LAN IP address pool. To specify static IP address for the modem router, do the following:

- a. Select the **Use fixed IP Address (not recommended)** radio button.

A pop-up window opens.

- b. Enter all static IP addresses.

7. Click the **Apply** button.

Your settings are saved. The modem router restarts.

8. To reconnect, close your browser, relaunch it, and log in to the modem router by entering **<http://www.routerlogin.net>**.

Set Up a WiFi Bridge

You can use the modem router as a WiFi bridge and connect multiple devices with WiFi at the faster 802.11ac speed. To do this, you need a WiFi router or access point (AP) in addition to the modem router: One device is connected to the Internet modem and the other one functions as a WiFi bridge. You can connect the modem router to the Internet modem and use the router or AP as a WiFi bridge (assuming that the router or AP is capable of functioning as a WiFi bridge), or the other way around—connect the router or AP to the Internet modem, and use the modem router as a WiFi bridge. Of course, you can also use two modem routers for such a setup.

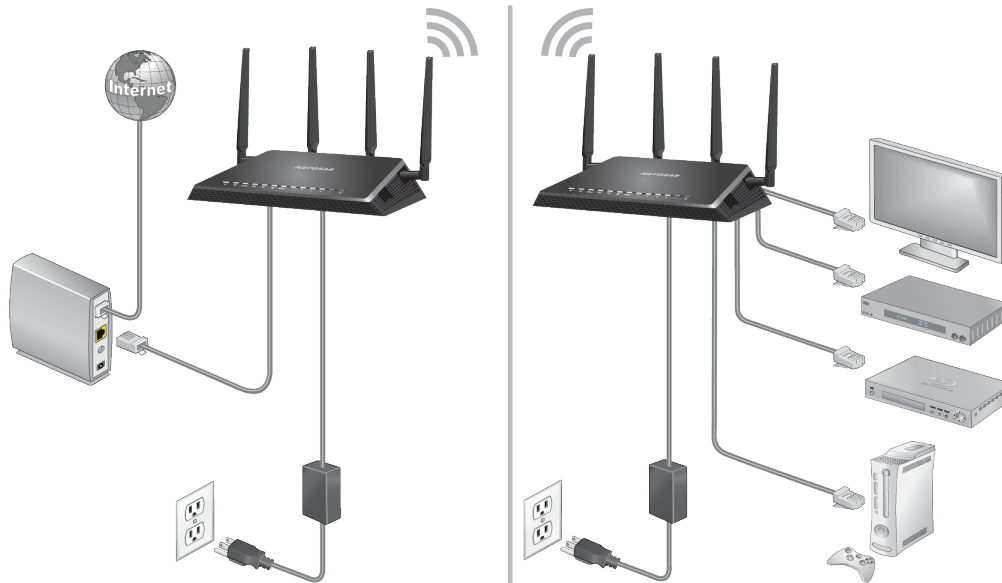

Figure 15. Bridge mode setup with an 802.11ac WiFi connection

Setting up a WiFi bridge with two modem routers offers the following benefits:

- You can take advantage of gigabit WiFi speeds on current devices.
- Use gigabit WiFi for applications such as video and gaming.
- Connect multiple devices such as a NAS, Smart TV, NeoTV, Blu-ray player, and game consoles at gigabit WiFi speeds using a WiFi link.
- Avoid the need for separate WiFi adapters for each device.

For example, you could install the first modem router in a room such as a home office where your Internet connection is located.

Then set up the second modem router as a WiFi bridge and place it in a different room such as the room where your home entertainment center is located. Cable the modem router that functions as a WiFi bridge to your Smart TV, DVR, game console, or Blu-ray player, and use its 802.11ac WiFi connection to the first modem router.

The modem router that is connected to the Internet modem does not require any special setup because the modem router that functions as a WiFi bridge connects to an existing SSID as a WiFi client, just like any other WiFi clients.

► To set up a modem router as a WiFi bridge:

1. Make a note of the WiFi settings of the other modem router that is connected to the Internet modem. You must know the SSID, WiFi security mode, WiFi password, and operating frequency (either 2.4 GHz or 5 GHz).
2. Launch a web browser from a computer or WiFi device that is connected to the network of the modem router that you are setting up as a WiFi bridge.
3. Enter **<http://www.routerlogin.net>**.
A login window opens.

Nighthawk X4S AC2600 WiFi VDSL/ADSL Modem Router Model D7800

4. Enter the modem router user name and password.
The user name is **admin**. The default password is **password**. The user name and password are case-sensitive.

The BASIC Home page displays.

5. Select **ADVANCED > Advanced Setup > Wireless Bridge**.

The Wireless Bridge page displays.

6. Select the **Enable Bridge mode** check box.

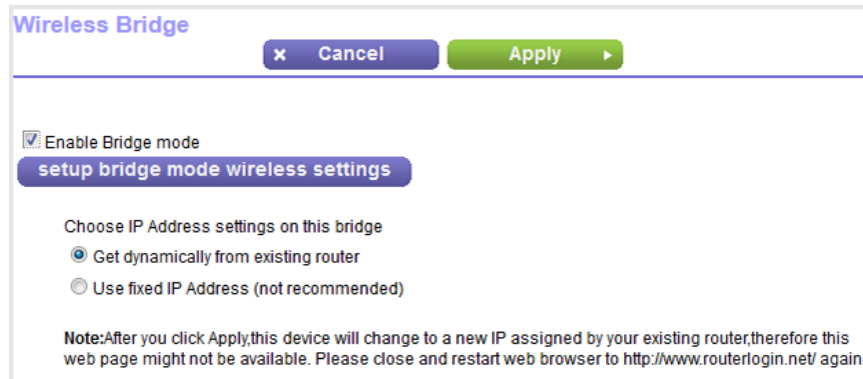

7. Click the **setup bridge mode wireless settings** button.

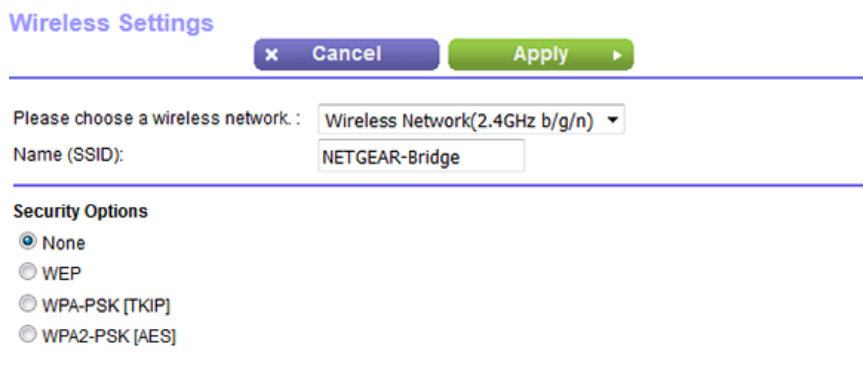

8. Enter the WiFi settings of the modem router that is connected to the Internet modem (that is, the other modem router):
 - a. From the **Please choose a wireless network** menu, select the WiFi band that the other modem router is using.
For 802.11ac mode, both modem routers must use the 5 GHz band.
 - b. In the **Name (SSID)** field, enter the WiFi network name (SSID) that the other modem router is using.
In the previous figure, the SSID name NETGEAR-Bridge is just an example.
 - c. In the Security Options section, select the radio button for the WiFi security that the other modem router is using.
 - d. If prompted, type the passphrase (the WiFi password that you must use to connect with WiFi to the other modem router).

Manage the Advanced WiFi Features

Nighthawk X4S AC2600 WiFi VDSL/ADSL Modem Router Model D7800

9. Click the **Apply** button.
Your settings are saved.
10. To let the modem router that functions as the WiFi bridge get an IP address dynamically from the modem router that is connected to the Internet modem, leave the **Get dynamically from existing router** radio button selected.
We recommend that you leave the **Get dynamically from existing router** radio button selected. However, if you are sure that must use a static IP address, you can specify a static IP address from your other router's LAN IP address pool. To specify static IP address for the modem router that functions as the WiFi bridge, do the following:
 - a. Select the **Use fixed IP Address (not recommended)** radio button.
A pop-up window opens.
 - b. Enter all static IP addresses.
11. Click the **Apply** button.
Your settings are saved. The modem router restarts with a new IP address.
12. To reconnect, close your browser, relaunch it, and log in to the modem router by entering **http://www.routerlogin.net**.
When the modem router functions as a WiFi bridge, you cannot change its WiFi settings, that is, the settings on the Wireless Settings page (**BASIC > Wireless**) are masked out.

You can use OpenVPN software to remotely access your modem router using virtual private networking (VPN). This chapter explains how to set up and use VPN access.

The chapter includes the following sections:

- *Set Up a VPN Connection* on page 239
- *Use a VPN Tunnel on a Windows-Based Computer* on page 243
- *Use VPN to Access the Modem Router's USB Device and Media From a Windows-Based Computer* on page 245
- *Use VPN to Access Your Internet Service at Home* on page 245

Set Up a VPN Connection

A virtual private network (VPN) lets you use the Internet to securely access your network when you are not home. This type of VPN access is called a client-to-gateway tunnel. The computer is the client, and the modem router is the gateway. To use the VPN feature, you must log in to the modem router and enable VPN, and you must install and run VPN client software on the computer.

Note The modem router does not support iOS or Android VPN client software.

VPN uses DDNS or a static IP address to connect with your modem router.

To use a DDNS service, register for an account with a host name (sometimes called a domain name). You use the host name to access your network. The modem router supports these accounts: NETGEAR, No-IP, and Dyn. *See [Set Up and Manage Dynamic DNS](#) on page 158.*

If your Internet service provider (ISP) assigned a static WAN IP address (such as 50.196.x.x or 10.x.x.x) that never changes to your Internet account, the VPN can use that IP address to connect to your home network.

Specify VPN Service in the Modem Router

You must specify the VPN service settings in the modem router before you can use a VPN connection.

► To specify the VPN service:

1. Launch a web browser from a computer or mobile device that is connected to the network.
2. Enter **http://www.routerlogin.net**.
A login window opens.
3. Enter the modem router user name and password.
The user name is **admin**. The default password is **password**. The user name and password are case-sensitive.
The BASIC Home page displays.
4. Select **ADVANCED > Advanced Setup > VPN Service**.
The VPN Service page displays.
5. Select the **Enable VPN Service** check box.
By default, the VPN uses the UDP service type and uses port 12974. If you want to customize the service type and port, we recommend that you change these settings before you install the OpenVPN software.
6. To change the service type, scroll down and select the **TCP** radio button.
7. To change the port, scroll down to the **Service Port** field, and type the port number that you want to use.

Note For information about configuring the type of access, see *Use VPN to Access Your Internet Service at Home* on page 245.

8. Click the **Apply** button.
Your settings are saved. VPN is enabled in the modem router, but you must install and set up OpenVPN software on your computer before you can use a VPN connection (see *Install OpenVPN Software on a Windows Computer* on page 240 and *Install OpenVPN Software on a Mac Computer* on page 242).

Install OpenVPN Software on a Windows Computer

You must install OpenVPN software on each computer that you plan to use for VPN connections to your modem router.

► To install VPN client software on a Windows computer:

1. Launch a web browser from a computer or mobile device that is connected to the network.
2. Enter **http://www.routerlogin.net**.
A login window opens.
3. Enter the modem router user name and password.
The user name is **admin**. The default password is **password**. The user name and password are case-sensitive.
The BASIC Home page displays.
4. Select **ADVANCED > Advanced Setup > VPN Service**.
The VPN Service page displays.
5. Make sure that the **Enable VPN Service** check box is selected.
For more information, see *Specify VPN Service in the Modem Router* on page 239.
6. Click the **For Windows** button to download the OpenVPN configuration files.
Step 17 provides information about what to do with the downloaded OpenVPN configuration files.
7. To download the OpenVPN client utility, visit openvpn.net/index.php/download/community-downloads.html.
8. In the Windows Installer section of the page, double-click the **openVPN-install-xxx.exe** link.
9. Download the file.

Nighthawk X4S AC2600 WiFi VDSL/ADSL Modem Router Model D7800

- To install the OpenVPN client utility on your computer, click the **openVPN-install-xxx.exe** file.



- Click the **Next** button.
- Read the License Agreement and click the **I Agree** button.

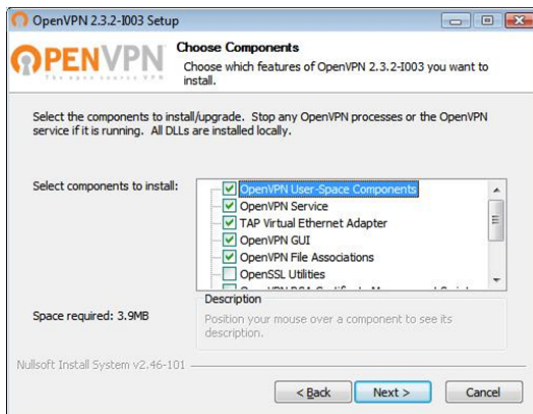

- Leave the check boxes selected as shown in the previous figure, and click the **Next** button.
- To specify the destination folder, click the **Browse** button, select a destination folder, and click the **Next** button.



- Click the **Install** button.

Nighthawk X4S AC2600 WiFi VDSL/ADSL Modem Router Model D7800

The window displays the progress of the installation and then displays the final installation window.

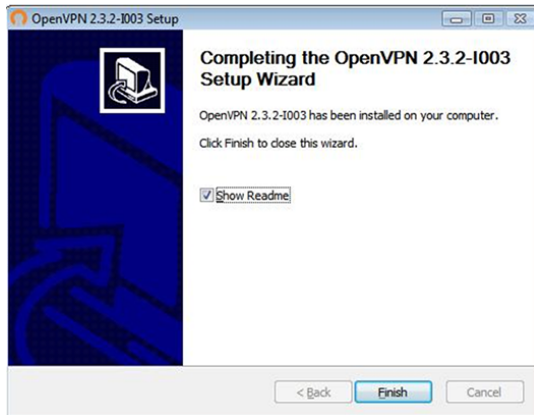

16. Click the **Finish** button.
17. Unzip the configuration files that you downloaded in Step 6 and copy them to the folder in which the OpenVPN client utility is installed on your computer.
If your device is a Windows 64-bit system, the OpenVPN client utility is installed by default in the `C:\Program files\OpenVPN\config\` folder.
18. Modify the VPN interface name to **NETGEAR-VPN**:
 - a. In Windows, select **Start > Control Panel > Network and Internet > Network Connections** (or **Network and Sharing Center**).
The network information displays.
 - b. In the local area connection list, find the local area connection with the device name **TAP-Windows Adapter**.
 - c. Select the local area connection and change its name (not its device name) to **NETGEAR-VPN**.

If you do not change the VPN interface name, the VPN tunnel connection will fail.

For more information about using OpenVPN on a Windows computer, visit openvpn.net/index.php/open-source/documentation/howto.html#quick.

Install OpenVPN Software on a Mac Computer

You must install Open VPN software on each computer that you plan to use for VPN connections to your modem router.

► To install VPN client software on a Mac computer:

1. Launch a web browser from a computer or mobile device that is connected to the network.
2. Enter **http://www.routerlogin.net**.
A login window opens.
3. Enter the modem router user name and password.

Nighthawk X4S AC2600 WiFi VDSL/ADSL Modem Router Model D7800

The user name is **admin**. The default password is **password**. The user name and password are case-sensitive.

The BASIC Home page displays.

4. Select **ADVANCED > Advanced Setup > VPN Service**.
The VPN Service page displays.
5. Make sure that the **Enable VPN Service** check box is selected.
For more information, see *Specify VPN Service in the Modem Router* on page 239.
6. Click the **For non-Windows** button to download the OpenVPN configuration files.
Step 9 provides information about what to do with the downloaded OpenVPN configuration files.
7. To download the OpenVPN client utility for Mac OS X, visit <https://tunnelblick.net/>.
8. Download and install the file.
9. Unzip the configuration files that you downloaded in Step 6 and copy them to the folder in which the OpenVPN client utility is installed on your computer.
The client utility must be installed by a user with administrative privileges.

For more information about using OpenVPN on a Mac computer, visit openvpn.net/index.php/access-server/docs/admin-guides/183-how-to-connect-to-access-server-from-a-mac.html.

Use a VPN Tunnel on a Windows-Based Computer

After you set up the modem router to use VPN and install the OpenVPN application on your computer, you can open a VPN tunnel from your computer to your modem router over the Internet.

For the VPN tunnel to work, the local LAN IP address of the remote router must use a different LAN IP scheme from that of the local LAN where your VPN client computer is connected. If both networks use the same LAN IP scheme, when the VPN tunnel is established, you cannot access your home router or your home network with the OpenVPN software.

The default LAN IP address scheme for the modem router is 192.x.x.x. The most common IP schemes are 192.x.x.x, 172.x.x.x, and 10.x.x.x. If you experience a conflict, change the IP scheme either for your home network or for the network with the client VPN computer. For information about changing these settings, see *Manage the Modem Routers's LAN IP Address Settings* on page 191.

▶ To open a VPN tunnel:

1. Launch the OpenVPN application with administrator privileges.



The **OpenVPN** icon displays in the Windows taskbar.

Tip You can create a shortcut to the VPN program, then use the shortcut to access the settings and select the **run as administrator** check box. Then every time you use this shortcut, OpenVPN automatically runs with administrator privileges.

2. Right-click the **OpenVPN** icon.



3. Select **Connect**.

The VPN connection is established. You can do the following:

- Launch a web browser and log in to your modem router.
- Use Windows file manager to access the modem router's USB device and download files.

Use VPN to Access the Modem Router's USB Device and Media From a Windows-Based Computer

► To access a USB device and download files:

1. In Windows file manager, select the **Network** folder.

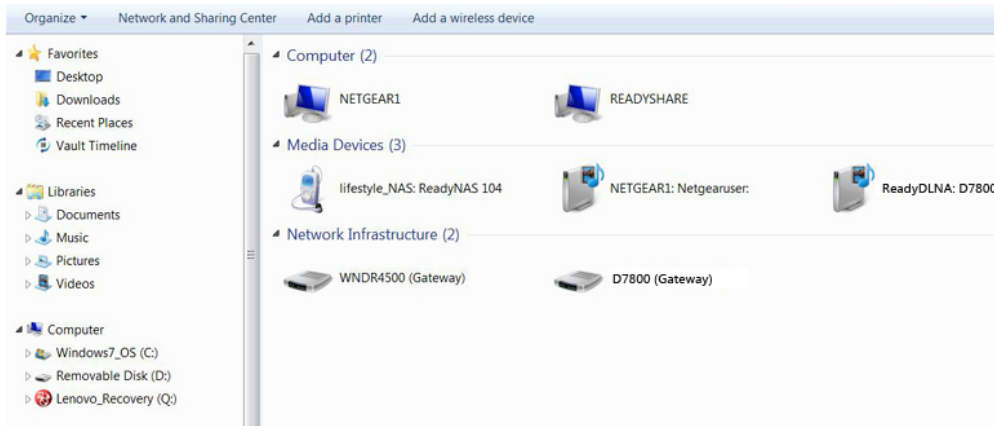

The network resources display. The **ReadySHARE** icon is in the Computer section and the remote **ReadyDLNA: D7800** icon is in the Media Devices section (if DLNA is enabled in the modem router).

2. If the icons do not display, click the **Refresh** button to update the page.
If the local LAN and the remote LAN are using the same IP scheme, the remote **ReadyDLNA: D7800** icon does not display in the Media Devices section and the **D7800 (Gateway)** icon does not display in the Network Infrastructure section.
3. To access the USB device, click the **ReadySHARE** icon.
4. To access media on the modem router's network, click the **ReadyDLNA: D7800** icon.

Use VPN to Access Your Internet Service at Home

When you are away from home and you access the Internet, you usually use a local Internet service provider. For example, at a coffee shop you might be given a code that lets you use the coffee shop's Internet service account to surf the web.

The modem router lets you use a VPN connection to access your own Internet service when you are away from home. You might want to do this if you travel to a geographic location that does not support all the Internet services that you use at home. For example, your Netflix account might work at home but not in a different country.

Set Up VPN Client Internet Access in the Modem Router

By default, the modem router is set up to allow VPN connections only to your home network, but you can change the settings to allow Internet access. Accessing the Internet remotely through a VPN might be slower than accessing the Internet directly.

► To allow VPN clients to use your home Internet service:

1. Launch a web browser from a computer or mobile device device that is connected to the network.
2. Enter **http://www.routerlogin.net**.
A login window opens.
3. Enter the modem router user name and password.
The user name is **admin**. The default password is **password**. The user name and password are case-sensitive.
The BASIC Home page displays.
4. Select **ADVANCED > Advanced Setup > VPN Service**.
The VPN page displays.
5. Select the **Enable VPN Service** radio button.
6. Scroll down to the Clients will use this VPN connection to access section, and select the **All sites on the Internet & Home Network** radio button.
When you access the Internet with the VPN connection, instead of using a local Internet service, you use the Internet service from your home network.

Note By default, the **Auto** radio button is selected, which lets the modem router use an automatic detection system that enables VPN access only for necessary services and sites and might not include full Internet access.

7. Click the **Apply** button.
Your settings are saved.
8. Click the **For Windows** or **For non-Windows** button and download the configuration files for your VPN clients.
9. Unzip the configuration files and copy them to the folder where the VPN client is installed on your device.
For a client device with Windows 64-bit system, the VPN client is installed at `C:\Program files\OpenVPN\config\` by default.

Block VPN Client Internet Access in the Modem Router

By default, the modem router is set up to allow VPN connections only to your home network, not to the Internet service for your home network. If you changed this setting to allow Internet access, you can change it back.

► To allow VPN clients to access only your home network:

1. Launch a web browser from a computer or mobile device device that is connected to the network.
2. Enter **http://www.routerlogin.net**.
A login window opens.
3. Enter the modem router user name and password.

Nighthawk X4S AC2600 WiFi VDSL/ADSL Modem Router Model D7800

The user name is **admin**. The default password is **password**. The user name and password are case-sensitive.

The BASIC Home page displays.

4. Select **ADVANCED > Advanced Setup > VPN Service**.
The VNP page displays.
5. Make sure that the **Enable VPN Service** radio button is selected.
6. Scroll down to the Clients will use this VPN connection to access section, and select the **Home Network only** radio button.
7. Click the **Apply** button.
Your settings are saved.

Use a VPN Tunnel to Access Your Internet Service at Home

► To access your Internet service:

1. Set up the modem router to allow VPN access to your Internet service.
See *Set Up VPN Client Internet Access in the Modem Router* on page 245.
2. On your computer, launch the OpenVPN application.
The **OpenVPN** icon displays in the Windows taskbar.
3. Right-click the icon and select **Connect**.
4. When the VPN connection is established, launch your web browser.

Manage Port Forwarding and Port Triggering

15

You can use port forwarding and port triggering to set up rules for Internet traffic for services and applications. You need networking knowledge to set up these features.

This chapter includes the following sections:

- *Manage Port Forwarding to a Local Server for Services and Applications* on page 249
- *Manage Port Triggering for Services and Applications* on page 254

Manage Port Forwarding to a Local Server for Services and Applications

If a server is part of your network, you can allow certain types of incoming traffic to reach the server. For example, you might want to make a local web server, FTP server, or game server visible and available to the Internet.

The modem router can forward incoming traffic with specific protocols to computers on your local network. You can specify the servers for applications and you can also specify a default DMZ server to which the modem router forwards all other incoming protocols (see *Set Up a Default DMZ Server* on page 188).

Forward Incoming Traffic for a Default Service or Application

You can forward traffic for a default service or application to a computer on your network.

► **To forward incoming traffic for a default service or application:**

1. Decide which type of service, application, or game you want to provide.
2. Find the local IP address of the computer on your network that will provide the service.
The server computer must always receive the same IP address. To specify this setting, use the reserved IP address feature. See *Manage Reserved LAN IP Addresses* on page 194.
3. Launch a web browser from a computer or mobile device that is connected to the network.
4. Enter **http://www.routerlogin.net**.
A login window opens.
5. Enter the modem router user name and password.
The user name is **admin**. The default password is **password**. The user name and password are case-sensitive.
The BASIC Home page displays.
6. Select **ADVANCED > Advanced Setup > Port Forwarding / Port Triggering**.

7. Make sure that the **Port Forwarding** radio button is selected.
8. From the **Service Name** menu, select the service or application.

If the service or application that you want to add is not in the list, create a port forwarding rule with a custom service or application (see *Add a Port Forwarding Rule With a Custom Service or Application* on page 250).

9. In the **Server IP Address** field, enter the IP address of the computer that must provide the service or that runs the application.
10. Click the **Add** button.
Your settings are saved and the rule is added to the table.

Add a Port Forwarding Rule With a Custom Service or Application

The modem router lists default services and applications that you can use in port forwarding rules. If the service or application is not predefined, you can add a port forwarding rule with a custom service or application.

► To add a port forwarding rule with a custom service or application:

1. Find out which port number or range of numbers the service or application uses.
You can usually find this information by contacting the publisher of the service or application or through user groups or news groups.
2. Launch a web browser from a computer or mobile device device that is connected to the network.
3. Enter **http://www.routerlogin.net**.
A login window opens.
4. Enter the modem router user name and password.
The user name is **admin**. The default password is **password**. The user name and password are case-sensitive.
The BASIC Home page displays.
5. Select **ADVANCED > Advanced Setup > Port Forwarding / Port Triggering**.
The Port Forwarding / Port Triggering page displays.
6. Make sure that the **Port Forwarding** radio button is selected.

Nighthawk X4S AC2600 WiFi VDSL/ADSL Modem Router Model D7800

- Click the **Add Custom Service** button.

- Specify a new port forwarding rule with a custom service or application as described in the following table.

Field	Description
Service Name	Enter the name of the custom service or application.
Protocol	Select the protocol (TCP or UDP) that is associated with the service or application. If you are unsure, select TCP/UDP .
External Starting Port	Enter the starting port number for the service or application.
External Ending Port	If the service or application uses a single port, enter the same port number in the External Ending Port field. If the service or application uses a range of ports, enter the ending port number of the range in the External Ending Port field.
Internal Starting Port	Specify the internal ports by one of these methods: <ul style="list-style-type: none"> If the external and internal ports are the same, leave the Use the same port range for Internal port check box selected. If the external and internal ports are different, in the Internal Starting Port field, enter the starting port number for the service or application. The Internal Ending Port field is populated automatically.
Internal Ending Port	
Internal IP address	Either enter an IP address in the Internal IP address field or select the radio button for an attached device that is listed in the table. The modem router applies the new rule to the device that you select.

- Click the **Apply** button.
Your settings are saved. The rule is added to the table on the Port Forwarding / Port Triggering page.

Change a Port Forwarding Rule

You can change an existing port forwarding rule.

► To change a port forwarding rule:

1. Launch a web browser from a computer or mobile device that is connected to the network.
2. Enter **http://www.routerlogin.net**.
A login window opens.
3. Enter the modem router user name and password.
The user name is **admin**. The default password is **password**. The user name and password are case-sensitive.
The BASIC Home page displays.
4. Select **ADVANCED > Advanced Setup > Port Forwarding / Port Triggering**.

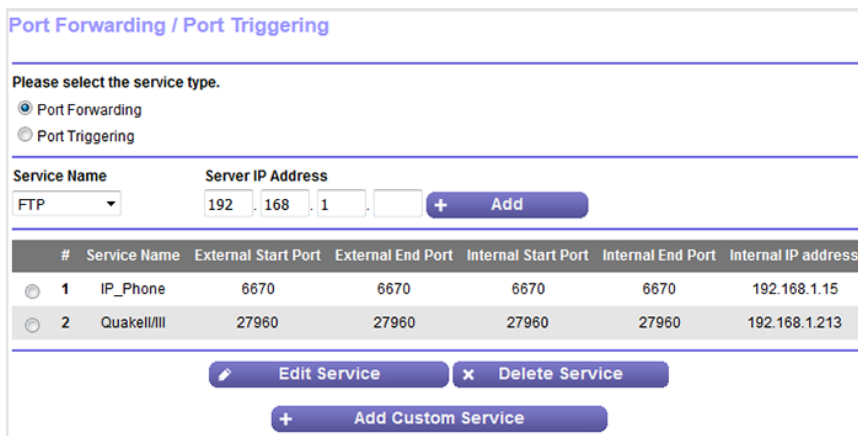

Port Forwarding / Port Triggering

Please select the service type.

Port Forwarding
 Port Triggering

Service Name: FTP Server IP Address: 192.168.1. Add

#	Service Name	External Start Port	External End Port	Internal Start Port	Internal End Port	Internal IP address
1	IP_Phone	6670	6670	6670	6670	192.168.1.15
2	Quakell/III	27960	27960	27960	27960	192.168.1.213

Edit Service Delete Service Add Custom Service

The previous figure shows two custom port forwarding rules.

5. Make sure that the **Port Forwarding** radio button is selected.
6. In the table, select the radio button for the service or application name.
7. Click the **Edit Service** button.
The Ports - Custom Services page displays.
8. Change the settings.
For information about the settings, see [Add a Port Forwarding Rule With a Custom Service or Application](#) on page 250.
9. Click the **Apply** button.
Your settings are saved. The changed rule displays in the table on the Port Forwarding / Port Triggering page.

Remove a Port Forwarding Rule

You can remove a port forwarding rule that you no longer need.

► To remove a port forwarding rule:

1. Launch a web browser from a computer or mobile that is connected to the network.
2. Enter **http://www.routerlogin.net**.
A login window opens.
3. Enter the modem router user name and password.
The user name is **admin**. The default password is **password**. The user name and password are case-sensitive.
The BASIC Home page displays.
4. Select **ADVANCED > Advanced Setup > Port Forwarding / Port Triggering**.

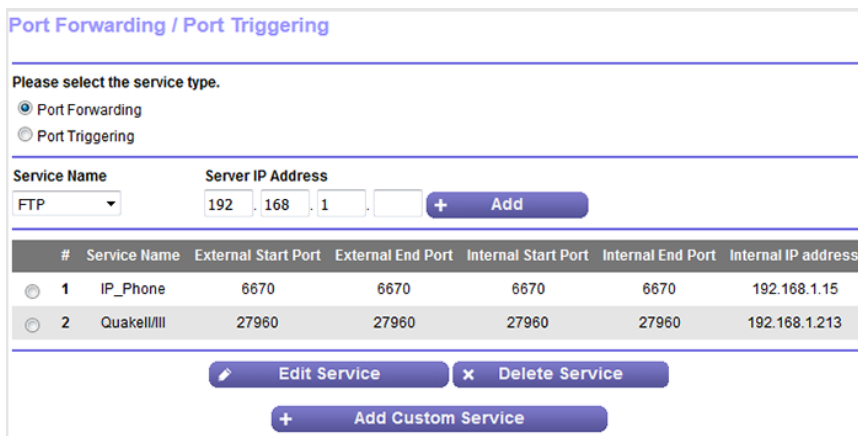

Port Forwarding / Port Triggering

Please select the service type.

Port Forwarding
 Port Triggering

Service Name: FTP Server IP Address: 192.168.1. Add

#	Service Name	External Start Port	External End Port	Internal Start Port	Internal End Port	Internal IP address
<input type="radio"/> 1	IP_Phone	6670	6670	6670	6670	192.168.1.15
<input type="radio"/> 2	Quakell/III	27960	27960	27960	27960	192.168.1.213

Edit Service Delete Service Add Custom Service

The previous figure shows two custom port forwarding rules.

5. Make sure that the **Port Forwarding** radio button is selected.
6. In the table, select the radio button for the service or application name.
7. Click the **Delete Service** button.
The rule is removed from the table.

Application Example: Make a Local Web Server Public

If you host a web server on your local network, you can use port forwarding to allow web requests from anyone on the Internet to reach your web server.

► To make a local web server public:

1. Assign your web server either a fixed IP address or a dynamic IP address using DHCP address reservation.
In this example, your router always gives your web server an IP address of 192.168.1.33.
2. On the Port Forwarding / Port Triggering page, configure the modem router to forward the HTTP service to the local address of your web server at **192.168.1.33**.
HTTP (port 80) is the standard protocol for web servers.
3. (Optional) Register a host name with a Dynamic DNS service, and specify that name on the Dynamic DNS page of the modem router.
Dynamic DNS makes it much easier to access a server from the Internet because you can enter the name in the web browser. Otherwise, you must know the IP address that the ISP assigned, which typically changes.

How the Modem Router Implements the Port Forwarding Rule

The following sequence shows the effects of a port forwarding rule:

1. When you enter the URL `www.example.com` in your browser, the browser sends a web page request message with the following destination information:
 - **Destination address.** The IP address of `www.example.com`, which is the address of your modem router.
 - **Destination port number.** 80, which is the standard port number for a web server process.
2. The modem router receives the message and finds your port forwarding rule for incoming port 80 traffic.
3. The router changes the destination IP address in the message to 192.168.1.123 and sends the message to that computer.
4. Your web server at IP address 192.168.1.123 receives the request and sends a reply message to your router.
5. Your modem router performs Network Address Translation (NAT) on the source IP address and sends the reply through the Internet to the computer or mobile device that sent the web page request.

Manage Port Triggering for Services and Applications

Port triggering is a dynamic extension of port forwarding that is useful in these cases:

- An application must use port forwarding to more than one local computer (but not simultaneously).
- An application must open incoming ports that are different from the outgoing port.

With port triggering, the modem router monitors traffic to the Internet from an outbound “trigger” port that you specify. For outbound traffic from that port, the modem router saves the IP address of the computer that sent the traffic. The modem router temporarily opens the incoming port or ports that you specify in your rule and forwards that incoming traffic to that destination.

Port forwarding creates a static mapping of a port number or range of ports to a single local computer. Port triggering can dynamically open ports to any computer when needed and close the ports when they are no longer needed.

Note If you use applications such as multiplayer gaming, peer-to-peer connections, real-time communications such as instant messaging, or remote assistance, enable Universal Plug-N-Play (UPnP). See *Improve Network Connections With Universal Plug-N-Play* on page 138.

Add a Port Triggering Rule

The modem router does not provide default services and applications for port triggering rules. You must define a custom service or application for each port triggering rule.

► To add a port triggering rule:

1. Launch a web browser from a computer or mobile device that is connected to the network.
2. Enter **http://www.routerlogin.net**.
A login window opens.
3. Enter the modem router user name and password.
The user name is **admin**. The default password is **password**. The user name and password are case-sensitive.
The BASIC Home page displays.
4. Select **ADVANCED > Advanced Setup > Port Forwarding / Port Triggering**.
The Port Forwarding / Port Triggering page displays.
5. Select the **Port Triggering** radio button.

Port Forwarding / Port Triggering

Please select the service type.

Port Forwarding

Port Triggering

Disable Port Triggering

Port Triggering Time-out (in minutes)

Port Triggering Portmap Table

#	Enable	Service Name	Service Type	Inbound Connection	Service User
---	--------	--------------	--------------	--------------------	--------------

6. Click the **Add Service** button.

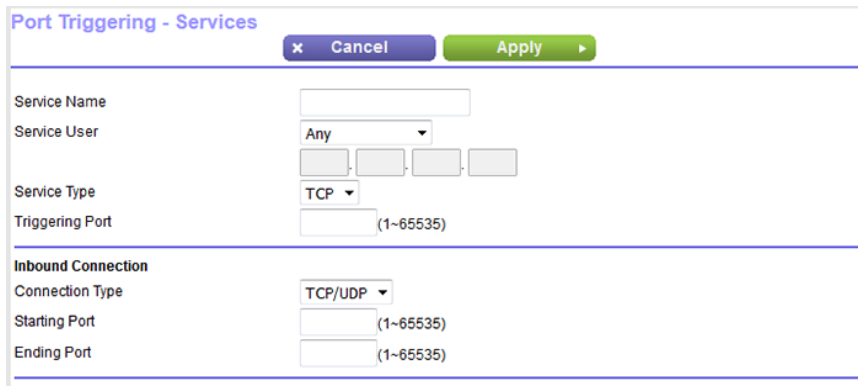

7. Specify a new port triggering rule with a custom service or application as described in the following table.

Field	Description
Service Name	Enter the name of the custom service or application.
Service User	From the Service User menu, select Any , or select Single address and enter the IP address of one computer: <ul style="list-style-type: none"> • Any. This is the default setting and allows any computer on the Internet to use this service. • Single address. Restricts the service to a particular computer.
Service Type	Select the protocol (TCP or UDP) that is associated with the service or application.
Triggering Port	Enter the number of the outbound traffic port that must open the inbound ports.
Inbound Connection	
Connection Type	Select the protocol (TCP or UDP) that is associated with the inbound connection. If you are unsure, select TCP/UDP .
Starting Port	Enter the start port number for the inbound connection.
Ending Port	Enter the end port number for the inbound connection.

8. Click the **Apply** button.

Your settings are saved and the rule is added to the Port Triggering Portmap Table on the Port Forwarding / Port Triggering page.

Change a Port Triggering Rule

You can change an existing port triggering rule.

► To change a port triggering rule:

1. Launch a web browser from a computer or mobile device that is connected to the network.
2. Enter **http://www.routerlogin.net**.
A login window opens.
3. Enter the modem router user name and password.
The user name is **admin**. The default password is **password**. The user name and password are case-sensitive.
The BASIC Home page displays.
4. Select **ADVANCED > Advanced Setup > Port Forwarding / Port Triggering**.
The Port Forwarding / Port Triggering page displays.
5. Select the **Port Triggering** radio button.

Port Forwarding / Port Triggering

Please select the service type.

Port Forwarding
 Port Triggering

Disable Port Triggering

Port Triggering Time-out(in minutes)

Port Triggering Portmap Table

#	Enable	Service Name	Service Type	Inbound Connection	Service User
<input checked="" type="radio"/> 1	<input checked="" type="checkbox"/>	FTPS	TCP:990	TCP/UDP:989..990	any
<input type="radio"/> 2	<input checked="" type="checkbox"/>	IRC SSL	TCP:6697	TCP/UDP:6697..6697	192.168.1.97

The previous figure shows two port triggering rules.

6. In the Port Triggering Portmap Table, select the radio button for the service or application name.
7. Click the **Edit Service** button.
The Port Triggering - Services page displays.
8. Change the settings.
For information about the settings, see [Add a Port Triggering Rule](#) on page 255.
9. Click the **Apply** button.
Your settings are saved. The changed rule displays in the Port Triggering Portmap Table on the Port Forwarding / Port Triggering page.

Remove a Port Triggering Rule

You can remove a port triggering rule that you no longer need.

► To remove a port triggering rule:

1. Launch a web browser from a computer or mobile that is connected to the network.
2. Enter **http://www.routerlogin.net**.
A login window opens.
3. Enter the modem router user name and password.
The user name is **admin**. The default password is **password**. The user name and password are case-sensitive.
The BASIC Home page displays.
4. Select **ADVANCED > Advanced Setup > Port Forwarding / Port Triggering**.
The Port Forwarding / Port Triggering page displays.
5. Select the **Port Triggering** radio button.

Port Forwarding / Port Triggering

Please select the service type.

Port Forwarding
 Port Triggering

Disable Port Triggering
 Port Triggering Time-out(in minutes)

#	Enable	Service Name	Service Type	Inbound Connection	Service User
1	<input checked="" type="checkbox"/>	FTPS	TCP:990	TCP/UDP:989..990	any
2	<input checked="" type="checkbox"/>	IRC SSL	TCP:6697	TCP/UDP:6697..6697	192.168.1.97

The previous figure shows two port triggering rules.

6. In the Port Triggering Portmap Table, select the radio button for the service or application name.
7. Click the **Delete Service** button.
The rule is removed from the Port Triggering Portmap Table.

Specify the Time-Out for Port Triggering

The time-out period for port triggering controls how long the inbound ports stay open when the modem router detects no activity. A time-out period is required because the modem router cannot detect when the service or application terminates.

► To specify the time-out for port triggering:

1. Launch a web browser from a computer or mobile device device that is connected to the network.
2. Enter **http://www.routerlogin.net**.

A login window opens.

3. Enter the modem router user name and password.
The user name is **admin**. The default password is **password**. The user name and password are case-sensitive.
The BASIC Home page displays.
4. Select **ADVANCED > Advanced Setup > Port Forwarding / Port Triggering**.
The Port Forwarding / Port Triggering page displays.
5. Select the **Port Triggering** radio button.
The port triggering settings display.
6. In the **Port Triggering Time-out** field, enter a value up to 9999 minutes.
The default setting is 20 minutes.
7. Click the **Apply** button.
Your settings are saved.

Disable Port Triggering

By default, port triggering is enabled. You can disable port triggering temporarily without removing any port triggering rules.

► To disable port triggering:

1. Launch a web browser from a computer or mobile device device that is connected to the network.
2. Enter **http://www.routerlogin.net**.
A login window opens.
3. Enter the modem router user name and password.
The user name is **admin**. The default password is **password**. The user name and password are case-sensitive.
The BASIC Home page displays.
4. Select **ADVANCED > Advanced Setup > Port Forwarding / Port Triggering**.
The Port Forwarding / Port Triggering page displays.
5. Select the **Port Triggering** radio button.
The port triggering settings display.
6. Select the **Disable Port Triggering** check box.
If this check box is selected, the modem router does not apply port triggering rules even if you specified them.
7. Click the **Apply** button.
Your settings are saved.

Application Example: Port Triggering for Internet Relay Chat

Some application servers, such as FTP and IRC servers, send replies to multiple port numbers. Using port triggering, you can tell the modem router to open more incoming ports when a particular outgoing port starts a session.

An example is Internet Relay Chat (IRC). Your computer connects to an IRC server at destination port 6667. The IRC server not only responds to your originating source port but also sends an “identify” message to your computer on port 113. Using port triggering, you can tell the modem router, “When you initiate a session with destination port 6667, you must also allow incoming traffic on port 113 to reach the originating computer.”

The following sequence shows the effects of this port triggering rule:

1. You open an IRC client program to start a chat session on your computer.
2. Your IRC client composes a request message to an IRC server using a destination port number of 6667, the standard port number for an IRC server process. Your computer then sends this request message to your modem router.
3. Your modem router creates an entry in its internal session table describing this communication session between your computer and the IRC server. Your modem router stores the original information, performs Network Address Translation (NAT) on the source address and port, and sends this request message through the Internet to the IRC server.
4. Noting your port triggering rule and observing the destination port number of 6667, your modem router creates another session entry to send any incoming port 113 traffic to your computer.
5. The IRC server sends a return message to your modem router using the NAT-assigned source port (for example, port 33333) as the destination port and also sends an “identify” message to your modem router with destination port 113.
6. When your modem router receives the incoming message to destination port 33333, it checks its session table to see if a session is active for port number 33333. Finding an active session, the modem router restores the original address information replaced by NAT and sends this reply message to your computer.
7. When your modem router receives the incoming message to destination port 113, it checks its session table and finds an active session for port 113 associated with your computer. The modem router replaces the message’s destination IP address with your computer’s IP address and forwards the message to your computer.
8. When you finish your chat session, your modem router eventually senses a period of inactivity in the communications. The modem router then removes the session information from its session table, and incoming traffic is no longer accepted on port numbers 33333 or 113.

This chapter provides information to help you diagnose and solve problems you might experience with your modem router. If you do not find the solution here, check the NETGEAR support site at support.netgear.com for product and contact information.

This chapter contains the following sections:

- *Reboot the Modem Router From Its Web Page* on page 262
- *Quick Tips for Troubleshooting* on page 262
- *Troubleshoot With the LEDs* on page 263
- *You Cannot Log In to the Modem Router* on page 265
- *Troubleshoot the Internet Connection* on page 265
- *Changes Are Not Saved* on page 269
- *Troubleshoot the WiFi Connectivity* on page 269
- *Troubleshoot Your Network Using the Ping Utility* on page 270

Reboot the Modem Router From Its Web Page

You or NETGEAR technical support can reboot the modem router from its web page, either locally or remotely, for example, when the modem router seems to be unstable or is not operating normally.

► To reboot the modem router from its web page:

1. Launch a web browser from a computer or mobile device that is connected to the network.
2. Enter **http://www.routerlogin.net**.
A login window opens.
3. Enter the modem router user name and password.
The user name is **admin**. The default password is **password**. The user name and password are case-sensitive.
The BASIC Home page displays.
4. Click the **ADVANCED** tab.
The ADVANCED Home page displays.
5. In the Router Information pane, click the **Reboot** button.
A confirmation pop-up window displays.
6. Click the **OK** button.
The modem router reboots.

Quick Tips for Troubleshooting

If your network is unresponsive or does not function normally, try the following:

Restart your network:

1. Turn off and unplug the DSL, cable, or fiber modem.
2. Turn off the modem router.
3. Plug in the DSL, cable, or fiber modem and turn it on. Wait two minutes.
4. Turn on the modem router and wait two minutes.
If network problems still occur, make sure that your ISP does not require you to use the MAC address of the computer that was used to initially register the ISP account. If your ISP does require that you do this, you must change the modem router MAC address that the modem router uses. For more information, see one of the following sections:
 - [Manually Set Up an ADSL Internet Connection](#) on page 49
 - [Manually Set Up a VDSL Internet Connection](#) on page 58
 - [Manually Set Up a Cable or Fiber Internet Connection](#) on page 66

If you cannot connect over an Ethernet cable to the modem router, try the following:

Nighthawk X4S AC2600 WiFi VDSL/ADSL Modem Router Model D7800







- Make sure that the Ethernet cables are securely plugged in.
- Make sure that your computer or device does not use a static IP address but is configured to receive an IP address automatically with DHCP. (For most devices, DHCP is the default setting.)

If you cannot connect over WiFi to the modem router, try the following:

- Make sure that the WiFi settings in your WiFi device and modem router match exactly. For a device that is connected over WiFi, the WiFi network name (SSID) and WiFi security settings of the modem router and WiFi computer must match exactly. The default SSID and password are on the product label (see [Bottom Panel Product Label](#) on page 17).
- Make sure that your WiFi device supports the security that you are using for your WiFi network (WEP, WPA, or WPA2). For information about WiFi security settings, see [Manage the Basic WiFi Settings and WiFi Security of the Main Network](#) on page 93.
- Make sure that the modem router is not too far from your WiFi device or too close. Move your WiFi device near the modem router but at least 6 feet (1.8 meters) away and see if the signal strength improves.
- Make sure that the WiFi signal is not blocked by objects between the modem router and your WiFi device.
- Make sure that the WiFi LED on the modem router is not off. If this LED is off, both WiFi radios might be disabled. For more information about the WiFi radios, see [Control the WiFi Radios](#) on page 108.
- Make sure that the modem router's SSID broadcast is not disabled. If the modem router's SSID broadcast is disabled, the WiFi network name is hidden and does not display in your WiFi device's scanning list. To connect to a hidden network, you must enter the network name and the WiFi password. For more information about the SSID broadcast, see [Manage the Basic WiFi Settings and WiFi Security of the Main Network](#) on page 93.
- Make sure that your WiFi device does not use a static IP address but is configured to receive an IP address automatically with DHCP. (For most devices, DHCP is the default setting.)

Troubleshoot With the LEDs

When you turn on the power, the LEDs light as described here:

1. One second after the power is first applied, the Power LED  lights solid amber for about 10 seconds, turns off for about 2 seconds, and then lights solid amber again.
2. About two minutes after the power is first applied, the Power LED lights solid white, indicating that the startup procedure is complete and the modem router is ready. Verify the following:
 - The DSL/Internet LED  is solid white.
 - The 2.4 GHz WiFi LED  and 5 GHz WiFi LED  are blinking white or solid white (unless you turned off the WiFi radios).
 - The WiFi LED  is solid white (unless you turned off the WiFi radios).
 - The WPS LED  is solid white.

Note If USB devices and an eSATA device are attached to the modem router, their associated LEDs also light.

You can use the LEDs for troubleshooting. For more information, see the following sections:

- *Power LED Is Off* on page 264
- *Power LED Remains Solid Amber* on page 264
- *WiFi LED Is Off* on page 264
- *Troubleshoot the Internet Connection* on page 265

Power LED Is Off

If the Power LED  and other LEDs are off when your modem router is turned on, do the following:

- Make sure that the **Power On/Off** button on the back is in the on position, that is, it is pushed in.
- Make sure that the power cord is correctly connected to your modem router and that the power supply adapter is correctly connected to a functioning power outlet.
- Make sure that you are using the 12 VDC 3.5A power adapter that NETGEAR supplied for this product.

If the error persists, a hardware problem might exist. For recovery instructions or help with a hardware problem, contact technical support at netgear.com/support.

Power LED Remains Solid Amber

One second after the power is first applied, the Power LED  lights solid amber for about 10 seconds, turns off for about 2 seconds, and then lights solid amber again. About two minutes after the power is first applied, the Power LED lights solid white, indicating that the startup procedure is complete and the modem router is ready.

If the Power LED remains solid amber and does not turn solid white, a failure occurred or the modem router is malfunctioning.

If the Power LED does not turn solid white, do the following:

1. Turn the power off and back on and wait several minutes to see if the modem router recovers.
2. If the modem router does not recover, press and hold the **Reset** button to return the modem router to its factory settings.

If the error persists, a hardware problem might exist. For recovery instructions or help with a hardware problem, contact technical support at netgear.com/support.

WiFi LED Is Off

If the WiFi LED  remains off, check to see if both radios on the modem router are disabled (see [Control the WiFi Radios](#) on page 108). By default, both radios are enabled and the WiFi LED lights solid white.

You Cannot Log In to the Modem Router

If you are unable to log in to the modem router from a computer on your local network and use the modem router web pages, check the following:

- If you are using an Ethernet-connected computer, check the Ethernet connection between the computer and the modem router.
- Make sure that the IP address of your computer is on the same subnet as the modem router. If you are using the recommended addressing scheme, your computer's address is in the range of 192.168.1.2 to 192.168.1.254.
- Make sure that your computer can reach the modem router's DHCP server. Recent versions of Windows and Mac OS generate and assign an IP address if the computer cannot reach a DHCP server. These autogenerated addresses are in the range of 169.254.x.x. If your IP address is in this range, check the connection from the computer to the modem router and reboot your computer.
- If your modem router's IP address was changed and you do not know the current IP address, use an IP scanner application to detect the IP address. If you still cannot find the IP address, clear the modem router's configuration to factory defaults. This sets the modem router's IP address to 192.168.1.1. For more information, see [Return the Modem Router to Its Factory Default Settings](#) on page 206 and [Factory Settings](#) on page 273.
- Make sure that Java, JavaScript, or ActiveX is enabled in your browser. If you are using Internet Explorer, click the **Refresh** button to be sure that the Java applet is loaded.
- Try quitting the browser and launching it again.
- Make sure that you are using the correct login information. The user name is **admin**, and the default password is **password**. Make sure that Caps Lock is off when you enter this information.
- If you are attempting to set up your modem router behind an existing router in your network, set up the modem router as a WiFi access point (see [Set Up the Modem Router as a WiFi Access Point Only](#) on page 233).

Troubleshoot the Internet Connection

If your modem router cannot access the Internet, check the DSL connection, then the WAN TCP/IP connection.

Troubleshoot the DSL/Internet Link

If your modem router is unable to access the Internet, first determine whether the DSL, cable, or fiber link with the service provider is working. The DSL/Internet LED indicates the state of this connection.

DSL/Internet LED Is Solid White

If the DSL/Internet LED  lights solid white, the DSL, cable, or fiber connection is good. You can be confident that the service provider connected your line correctly and that your wiring is correct.

DSL/Internet LED Is Blinking White (DSL Connection Only)

If the DSL/Internet LED  is blinking white, your modem router is attempting to make a DSL connection with your ISP. If the modem router establishes a DSL connection, the DSL/Internet LED turns solid white. This connection process generally lasts several minutes.

If the DSL/Internet LED does not turn solid white, disconnect all telephones on the line. If this solves the problem, reconnect the telephones one at a time, being sure to use a microfilter on each telephone. If the microfilters are connected correctly, you can connect all your telephones.

If disconnecting telephones does not result in a solid white DSL/Internet LED, a problem with your wiring might exist. If the telephone company tested the DSL signal at your network interface device (NID), then wiring in your house might be of poor quality.

DSL/Internet LED Is Off

If the DSL/Internet LED  is off, the modem router cannot connect to the Internet or to your Internet service provider (ISP). To resolve the problem, you can try the following steps.

► To reenble the modem router to connect to the Internet or your ISP:

1. If you are using a DSL connection to your ISP, do the following:
 - a. Disconnect all telephones on the line. If this solves the problem, reconnect the telephones one at a time, being sure to use a microfilter on each telephone. If the microfilters are connected correctly, you can connect all your telephones.
 - b. Check to see that the telephone company made the connection to your line and tested it.
 - c. Verify that you are connected to the correct telephone line. If more than one phone line is installed, be sure that you are connected to the line with the DSL service. It might be necessary to use a swapper if your DSL signal is on pins 1 and 4 or the RJ-11 jack. The modem router uses pins 2 and 3.
2. If you are using a cable or fiber connection to your ISP, check to see if all cable connections between the modem router and the cable or fiber modem are good. All cables should be fully inserted in the ports.
3. Check to see that your login credentials are correct or that the information you entered for the ISP connection is correct.

For more information, see one of the following sections:

- [Manually Set Up an ADSL Internet Connection](#) on page 49
 - [Manually Set Up a VDSL Internet Connection](#) on page 58
 - [Manually Set Up a Cable or Fiber Internet Connection](#) on page 66
4. Check to see if your ISP is experiencing a problem—it might not be that the modem router cannot connect to the Internet, but rather that your ISP cannot provide an Internet connection.

Obtain an Internet IP Address

If the modem router cannot access the Internet but the DSL/Internet LED  lights solid white, see if the modem router can obtain an Internet IP address from the ISP. Unless the modem router is assigned a static

IP address, the modem router requests an IP address from the ISP. You can determine whether the request was successful using the modem router web pages.

► To check the Internet IP address:

1. Launch a web browser from a computer or WiFi device that is connected to the network.
2. Enter **http://www.routerlogin.net**.
A login window opens.
3. Enter the modem router user name and password.
The user name is **admin**. The default password is **password**. The user name and password are case-sensitive.
The BASIC Home page displays.
4. Select **ADVANCED > ADVANCED Home**.
The ADVANCED Home page displays.
5. In the Internet Port pane, check to see that the IP Address field shows a valid IP address.
If the field shows 0.0.0.0, your modem router did not obtain an IP address from your ISP.

If your modem router cannot obtain an IP address from the ISP, the problem might be one of the following:

- Your Internet service provider (ISP) might require a login program. Ask your ISP whether they require PPP over Ethernet (PPPoE) or some other type of login.
- If you selected a login program, the service name, user name, or password could be incorrectly set. Before you make any changes, verify that the modem router can get a PPPoE, PPPoA, PPTP, or L2TP connection (see [Verify the PPPoE, PPPoA, PPTP, or L2TP Connection](#) on page 268).
- Your ISP might check for your computer's host name. Assign the computer host name of your ISP account as the account name. For more information, see one of the following sections:
 - [Manually Set Up an ADSL Internet Connection](#) on page 49
 - [Manually Set Up a VDSL Internet Connection](#) on page 58
 - [Manually Set Up a Cable or Fiber Internet Connection](#) on page 66
- If your ISP allows only one Ethernet MAC address to connect to Internet and checks for your computer's MAC address, inform your ISP that you bought a new network device and ask them to use the modem router's MAC address.
- Configure your modem router to clone your computer's MAC address. For more information, see one of the following sections:
 - [Manually Set Up an ADSL Internet Connection](#) on page 49
 - [Manually Set Up a VDSL Internet Connection](#) on page 58
 - [Manually Set Up a Cable or Fiber Internet Connection](#) on page 66

Verify the PPPoE, PPPoA, PPTP, or L2TP Connection

If you use a PPPoE, PPPoA, PPTP, or L2TP connection to your ISP, make sure that the connection works.

► To verify that your PPPoE, PPPoA, PPTP, or L2TP connection is working:

1. Launch a web browser from a computer or WiFi device that is connected to the network.
2. Enter **http://www.routerlogin.net**.
A login window opens.
3. Enter the modem router user name and password.
The user name is **admin**. The default password is **password**. The user name and password are case-sensitive.
The BASIC Home page displays.
4. Select **ADVANCED > ADVANCED Home**.
The ADVANCED Home page displays.
5. In the Internet Port pane, check to see that the IP Address field shows a valid IP address and that the Connection field shows the protocol that your connection is using (PPPoE, PPPoA, PPTP, or L2TP).
6. In the Internet Port pane, click the **Connection Status** button.
The Connection Status page displays.
7. Check the following:
 - The Connection Status field shows Connected.
 - The Connection Time field does *not* show 00:00:00.
8. If the Connection Status field does not show Connected, try to reconnect by clicking the **Connect** button.

If the PPPoE, PPPoA, PPTP, or L2TP connection is not working, make sure that your service name, user name, and password are set correctly. Or your ISP might not be able to provide an Internet connection. For more information, see one of the following sections:

- [Specify an ADSL Connection With a Login and PPPoA or PPPoE Service](#) on page 54
- [Specify a VDSL Connection With a Login and PPPoE Service](#) on page 62
- [Specify a Cable or Fiber Connection With a Login and PPPoE Service](#) on page 70
- [Specify a Cable or Fiber Connection With a Login and PPTP or L2TP Service](#) on page 74

Troubleshoot Internet Browsing

If your modem router can obtain an IP address but your computer is unable to load any web pages from the Internet, it might be for one of the following reasons:

- The traffic meter is enabled, and the limit was reached.

Nighthawk X4S AC2600 WiFi VDSL/ADSL Modem Router Model D7800

By configuring the traffic meter not to block Internet access when the traffic limit is reached, you can resume Internet access (see [Unblock the Traffic Meter After the Traffic Limit Is Reached](#) on page 225). If your ISP sets a usage limit, they might charge you for the overage.

- Your computer might not recognize any DNS server addresses.
A DNS server is a host on the Internet that translates Internet names (such as www addresses) to numeric IP addresses. Typically your ISP provides the addresses of one or two DNS servers for your use. If you entered a DNS address when you set up the modem router, reboot your computer and verify the DNS address. Alternatively, you can configure your computer manually with DNS addresses, as explained in your operating system documentation.
- The modem router might not be configured as the TCP/IP router on your computer.
For information about TCP/IP problems, see [Troubleshoot Your Network Using the Ping Utility](#) on page 270.
If your computer obtains its information from the modem router by DHCP, reboot the computer and verify the modem router address.

Changes Are Not Saved

If the modem router does not save the changes that you make on a modem router web page, do the following:

- When entering configuration settings, always click the **Apply** button before moving to another page or tab or your changes are lost.
- Click the **Refresh** or **Reload** button in the web browser. It is possible that the changes occurred but that the old settings remain in the web browser's cache.

Troubleshoot the WiFi Connectivity

If you are experiencing trouble connecting over WiFi to the modem router, try to isolate the problem:

- Make sure that the WiFi settings in your WiFi device and modem router match exactly.
For a device that is connected over WiFi, the WiFi network name (SSID) and WiFi security settings of the modem router and WiFi computer must match exactly. The default SSID and password are on the product label (see [Bottom Panel Product Label](#) on page 17).
- Does the WiFi device that you are using find your WiFi network?
If not, check the WiFi LED  on the top of the modem router. If this LED is off, both WiFi radios might be disabled. For more information about the WiFi radios, see [Control the WiFi Radios](#) on page 108.
- If you disabled the modem router's SSID broadcast, your WiFi network is hidden and does not display in your WiFi client's scanning list. (By default, SSID broadcast is enabled.) For more information, see [View or Change the Basic WiFi Settings](#) on page 93.
- Does your WiFi device support the security that you are using for your WiFi network (WEP, WPA, or WPA2)? For information about changing the WiFi security, see [View or Change the Basic WiFi Settings](#) on page 93.

Tip If you want to change the WiFi settings of the modem router's main network, use a wired connection to avoid being disconnected when the new WiFi settings take effect.

If your WiFi device finds your network but the signal strength is weak, check these conditions:

- Is your modem router too far from your WiFi device or too close? Place your WiFi device near the modem router but at least 6 feet (1.8 meters) away and see whether the signal strength improves.
- Are objects between the modem router and your WiFi device blocking the WiFi signal?

Troubleshoot Your Network Using the Ping Utility

Most network devices and routers contain a ping utility that sends an echo request packet to the designated device. The device then responds with an echo reply. You can easily troubleshoot a network using the ping utility in your computer or workstation.

Test the LAN Path to Your Modem Router

You can ping the modem router from your computer to verify that the LAN path to your modem router is set up correctly.

► To ping the modem router from a Windows computer:

1. From the Windows taskbar, click the **Start** button and select **Run**.
2. In the field provided, enter **ping** followed by the IP address of the modem router, as in this example:
ping 192.168.1.1
3. Click the **OK** button.

A message such as the following one displays:

```
Pinging <IP address> with 32 bytes of data
```

If the path is working, you see this message:

```
Reply from < IP address >: bytes=32 time=NN ms TTL=xxx
```

If the path is not working, you see this message:

```
Request timed out
```

If the path is not functioning correctly, one of the following problems might be occurring:

- **Wrong physical connections**
For a wired connection, make sure that the numbered LAN LED is lit for the port to which you are connected.
Check that the appropriate LEDs are on for your network devices. If your modem router and computer are connected to a separate Ethernet switch, make sure that the link LEDs are lit for the switch ports that are connected to your computer and modem router.
- **Wrong network configuration**
Verify that the Ethernet card driver software and TCP/IP software are both installed and configured on your computer.
Verify that the IP address for your modem router and your computer are correct and that the addresses are on the same subnet.

Test the Path From Your Computer to a Remote Device

After you verify that the LAN path works correctly, test the path from your computer to a remote device.

▶ To test the path from your computer to a remote device:

1. From the Windows toolbar, click the **Start** button and select **Run**.
2. In the field provided, enter
ping -n 10 *IP address*
where *IP address* is the IP address of a remote device such as your ISP's DNS server.

If the path is functioning correctly, replies as described in [Test the LAN Path to Your Modem Router](#) on page 270 display. If you do not receive replies, do the following:

- Check to see that the IP address of your modem router is listed as the default router in your computer. If the IP configuration of your computer is assigned by DHCP, this information is not visible in your computer's Network Control Panel. Verify that the IP address of the modem router is listed as the default router.
- Check to see that the network address of your computer (the portion of the IP address specified by the netmask) is different from the network address of the remote device.
- If your ISP assigned a host name to your computer, enter that host name as the account name. For more information, see one of the following sections:
 - [Specify an ADSL Connection Without a Login](#) on page 49
 - [Specify a VDSL Connection Without a Login](#) on page 58
 - [Specify a Cable or Fiber Connection Without a Login](#) on page 67
- Your ISP might be rejecting the Ethernet MAC addresses of all but one of your computers. Many broadband ISPs restrict access by allowing traffic only from the MAC address of your modem, but some additionally restrict access to the MAC address of a single computer connected to that modem. In this case, configure your modem router to clone or spoof the MAC address from the authorized computer. For more information, see one of the following sections:
 - [Manually Set Up an ADSL Internet Connection](#) on page 49
 - [Manually Set Up a VDSL Internet Connection](#) on page 58
 - [Manually Set Up a Cable or Fiber Internet Connection](#) on page 66

This appendix covers the following topics:

- *Factory Settings* on page 273
- *Technical Specifications* on page 275

Factory Settings

You can reset the modem router to the factory default settings that are shown in the following table.

For more information about resetting the modem router to its factory settings, see [Return the Modem Router to Its Factory Default Settings](#) on page 206.

Table 4. D7800 modem router factory default settings

Feature	Default Setting
Router login	
User login URL	www.routerlogin.net (or www.routerlogin.com or 192.168.1.1)
User name (case-sensitive)	admin
Login password (case-sensitive)	password
Internet connection	
WAN MAC address	Use default hardware address
WAN MTU size	Determined by the protocol that is used for the Internet connection (see MTU Concepts on page 90)
Port speed	Autosensing
Local network (LAN)	
LAN IP address	192.168.1.1
Subnet mask	255.255.255.0
DHCP server	Enabled
DHCP range	192.168.1.2 to 192.168.1.254
DHCP starting IP address	192.168.1.2
DHCP ending IP address	192.168.1.254
DMZ	Disabled
Time zone	<ul style="list-style-type: none"> • North America: Pacific Standard Time • Europe: GMT • Other continents: Varies by region
Time adjusted for daylight saving time	Disabled
Main WiFi network	

Table 4. D7800 modem router factory default settings (Continued)

Feature	Default Setting
WiFi communication	Enabled
SSID name	See product label
Security	WPA2-PSK (AES)
WiFi passphrase	See product label
Country/region	<ul style="list-style-type: none"> • North America: United States • Europe: Europe • Other continents: Varies by region
RF channel	Auto. The available channels depend on the region.
Transmission speed	Auto <hr/> <p>Note Throughput can vary. Network conditions and environmental factors, including volume of network traffic, building materials and construction, and network overhead, affect the data throughput rate.</p> <hr/>
Operating mode	<ul style="list-style-type: none"> • Up to 800 Mbps at 2.4 GHz • Up to 1733 Mbps at 5 GHz
Transmit power	100%
Guest WiFi network	
WiFi communication	Disabled
SSID name	<ul style="list-style-type: none"> • 2.4 GHz band: NETGEAR-Guest • 5 GHz band: NETGEAR-5G-Guest
Security	None (open network)
Allow guests to access main network	Disabled
General WiFi settings	
Radio transmission power	100%
20/40 MHz coexistence	Enabled

Table 4. D7800 modem router factory default settings (Continued)

Feature	Default Setting
Fragmentation length	2346
CTS/RTS threshold	2347
Preamble mode	Automatic
WPS	
WPS capability	Enabled
Modem router's PIN	Enabled; see the modem router web pages (select ADVANCED > Advanced Setup > Wireless Settings)
Keep Existing Wireless Settings	Enabled

Technical Specifications

Table 5. D7800 modem router specifications

Feature	Description
Data and routing protocols	TCP/IP, RIP-1, RIP-2, DHCP, PPPoE, PPPoA, PPTP, L2TP, Dynamic DNS, UPnP, and SMB
Power adapter	<ul style="list-style-type: none"> • North America: 120V, 60 Hz, input • UK, Australia: 240V, 50 Hz, input • Europe: 230V, 50 Hz, input • All regions: 12V @ 3.5A output
Dimensions	Dimensions: 285 x 185 x 50 mm (11.22 x 7.26 x 1.97 in.)
Weight	Weight: 840 g (1.85 lb)
Operating temperature	0° to 40°C (32° to 104°F)
Operating humidity	90% maximum relative humidity, noncondensing
Electromagnetic emissions	<ul style="list-style-type: none"> • EN 55022:2010/AC:2011, Class B • CISPR 22:2008, Class B • AS/NZS CISPR 22:2009/Amdt 1:2010, Class B

Table 5. D7800 modem router specifications (Continued)

Feature	Description
DSL	One RJ-11 asynchronous DSL (ADSL/VDSL) port
WAN	One RJ-45 port supporting 10BASE-T, 100BASE-TX, and 1000BASE-T
LAN	Four RJ-45 ports supporting 10BASE-T, 100BASE-TX, and 1000BASE-T
USB	Two USB 3.0 ports
eSATA	One eSATA port
WiFi	<p>Maximum WiFi signal rate complies with the IEEE 802.11 standard.</p> <hr/> <p>Note Throughput can vary. Network conditions and environmental factors, including volume of network traffic, building materials and construction, and network overhead, affect the data throughput rate.</p> <hr/>
Radio data rates	Auto-rate sensing
Data encoding standards	<ul style="list-style-type: none"> • IEEE 802.11ac 2.0 • IEEE 802.11n version 2.0 • IEEE 802.11n 256QAM IEEE 802.11g, IEEE 802.11b 2.4 GHz IEEE 802.11n, IEEE 802.11a 5.0 GHz
Maximum computers per WiFi network	Limited by the amount of WiFi network traffic generated by each node (typically 50–70 nodes)
Operating frequency range	<ul style="list-style-type: none"> • 2.4 GHz band <ul style="list-style-type: none"> - US: 2.412–2.462 GHz - Europe: 2.412–2.472 GHz - Australia: 2.412–2.472 GHz - Japan: 2.412–2.472 GHz • 5 GHz band <ul style="list-style-type: none"> - US: 5.18–5.24 + 5.745–5.825 GHz and DFS (5.25–5.35 + 5.50–5.70) - Europe: 5.18–5.24 GHz and DFS (5.25–5.35 + 5.50–5.70) - Australia: 5.18–5.24 + 5.745–5.825 GHz and DFS (5.25–5.35 + 5.50–5.70) - Japan: 5.18–5.24 GHz and DFS (5.25–5.35 + 5.50–5.70)

Table 5. D7800 modem router specifications (Continued)

Feature	Description
802.11 security	WPA2-PSK, WPA-PSK, WPA/WPA2 (mixed mode), WPA/WPA2 Enterprise, and WEP
xDSL data rate	<ul style="list-style-type: none"> • VDSL2, VDSL, ADSL2+, ADSL2, and ADSL multimode • Up to 100 Mbps, both upstream and downstream • Supports Annex A, L, and M • Supports all VDSL2 profiles: 8a, 8b, 8c, 8d, 12a, 12b, and 17a • VDSL2 interface compliance with ITU-T993.2 • G.992.1 (G.dmt), Annex A compliant • G.992.2 (G.lite), Annex A compliant • ANSI T1.413 compliant • G.992.3 (ADSL2) compliant, Annex A, L, and M • G.992.5 (ADSL2+) compliant, supporting Annex A and M • G.993.2 compliant, Annex A • G.993.5 (Vectoring) • ATM and PTM (dual-priority)

Note For more information, see the data sheet for the D7800 modem router, which is available at downloadcenter.netgear.com.
